

Enumerating labeled trees

Definition: A labeled tree is a tree the vertices of which are assigned unique numbers from 1 to n .

We can count such trees for small values of n by hand so as to conjecture a general formula.

Enumerating labeled trees

Definition: A labeled tree is a tree the vertices of which are assigned unique numbers from 1 to n .

We can count such trees for small values of n by hand so as to conjecture a general formula.

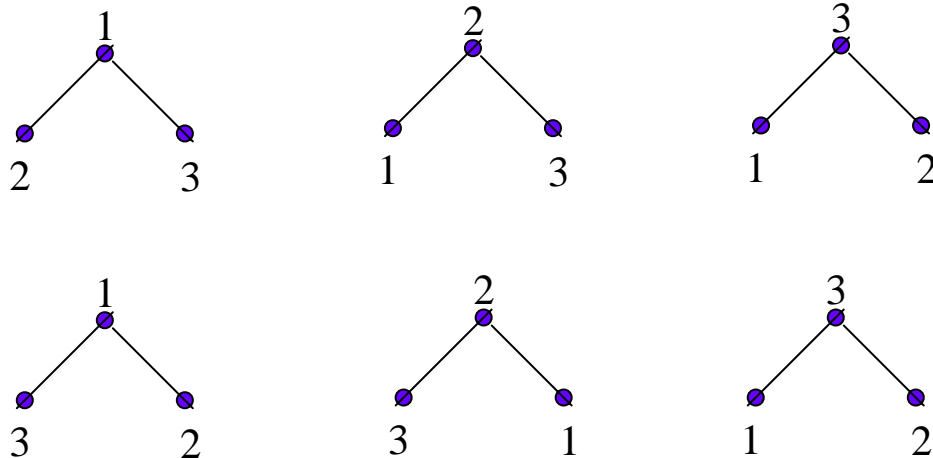

Enumerating labeled trees

Definition: A labeled tree is a tree the vertices of which are assigned unique numbers from 1 to n .

We can count such trees for small values of n by hand so as to conjecture a general formula.

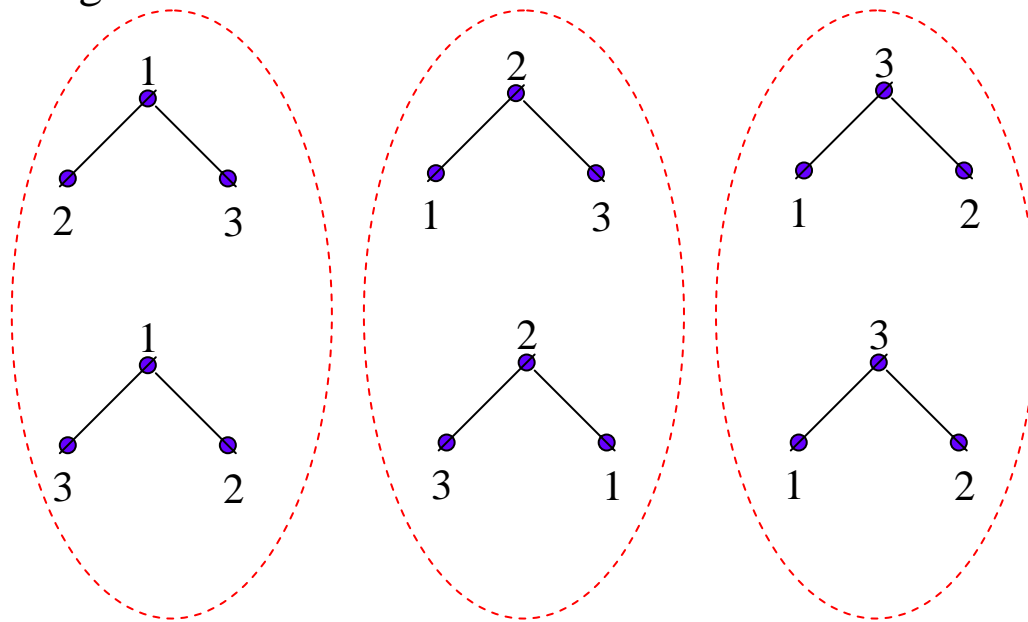

Enumerating labeled trees

Definition: A labeled tree is a tree the vertices of which are assigned unique numbers from 1 to n .

We can count such trees for small values of n by hand so as to conjecture a general formula.

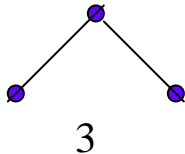

Enumerating labeled trees

Definition: A labeled tree is a tree the vertices of which are assigned unique numbers from 1 to n .

We can count such trees for small values of n by hand so as to conjecture a general formula.

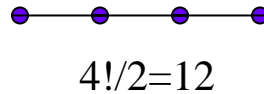
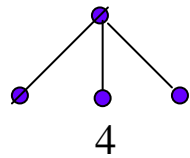
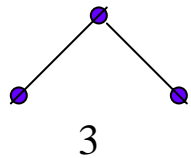

Enumerating labeled trees

Definition: A labeled tree is a tree the vertices of which are assigned unique numbers from 1 to n .

We can count such trees for small values of n by hand so as to conjecture a general formula.

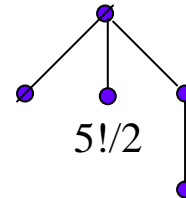
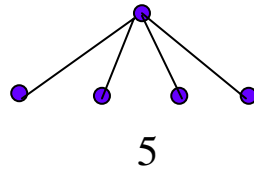
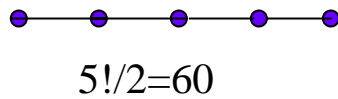
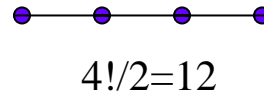
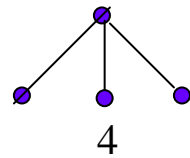
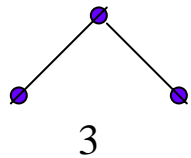

So what is the general formula?

Let T_n denote the number of labeled trees on n vertices. We now know the following values for small n :

$T_2 = 1$ as there is only one tree on 2 vertices

So what is the general formula?

Let T_n denote the number of labeled trees on n vertices. We now know the following values for small n :

$T_2 = 1$ as there is only one tree on 2 vertices

$T_3 = 3$ as we have seen before:

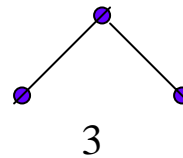

So what is the general formula?

Let T_n denote the number of labeled trees on n vertices. We now know the following values for small n :

$T_2 = 1$ as there is only one tree on 2 vertices

$T_3 = 3$ as we have seen before:

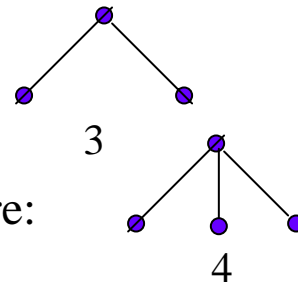

$T_4 = 4+12=16$ as we have also seen before:

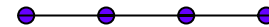

So what is the general formula?

Let T_n denote the number of labeled trees on n vertices. We now know the following values for small n :

$T_2 = 1$ as there is also one tree on 2 vertices

$T_3 = 3$ as we have seen before:

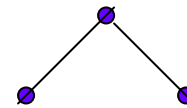

3

$T_4 = 4 + 12 = 16$ as we have also seen before:

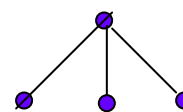

4



$24!/2=12$

$T_5 = 60 + 5 + 60 = 125$

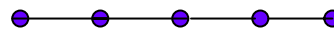

$5!/2=60$

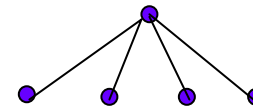

5

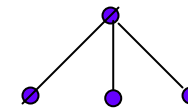

$5!/2$

So what is the general formula?

If we continue in this fashion, we will obtain the
following sequence:

1, 3, 16, 125, 1296, 16807, 262144...

So what is the general formula?

If we continue in this fashion, we will obtain the following sequence:

1, 3, 16, 125, 1296, 16807, 262144...

$$T_n = n^{n-2}$$

Cayley's theorem

Theorem (Cayley) There are n^{n-2} labeled trees on n vertices.

1. Induction

$$A \subset \{1, 2, \dots, n\}, |A| = k$$

$F(A, n)$ - the set of forests on n vertices in which vertices from A appear in different connected components (trees).

$T_{n,k}$ - the number of forests of k trees, for which the vertices from A appear in different components.

Cayley's theorem - induction

$$A = \{n - k + 1, n - k + 2, \dots, n\}, |A| = k$$

$F(A, n)$ - the set of forests on n vertices in which vertices from A appear in different connected components (trees).

$T_{n,k}$ - the number of forests of k trees, for which the vertices from A appear in different components.

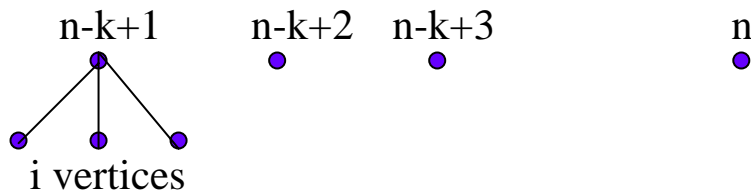

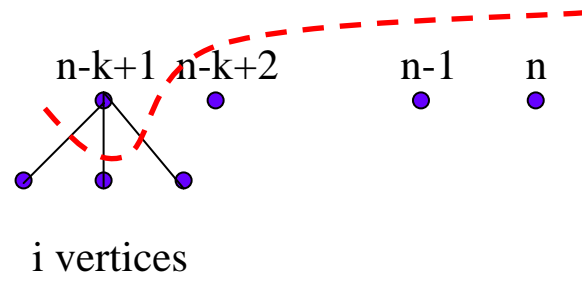

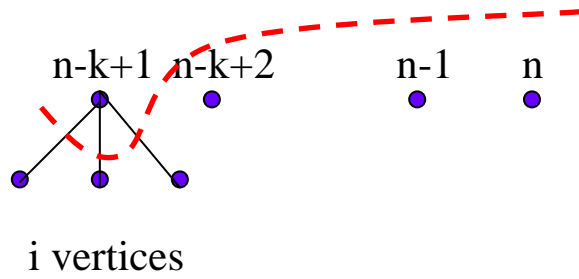

$$F(A, n) \leftrightarrow \{F(A', n-1), A' = (A \setminus \{n\}) \cup \{i \text{ chosen vertices}\}\}$$

$$T_{n,k} = \sum_{i=0}^{n-k} \binom{(n-1) - (k-1)}{i} T_{n-1, k+i-1}$$

$$T_{n,k} = kn^{n-k-1}$$

2. Establishing a 1-1 correspondence between trees and functions acting from 1..n into 1..n (Joyal)

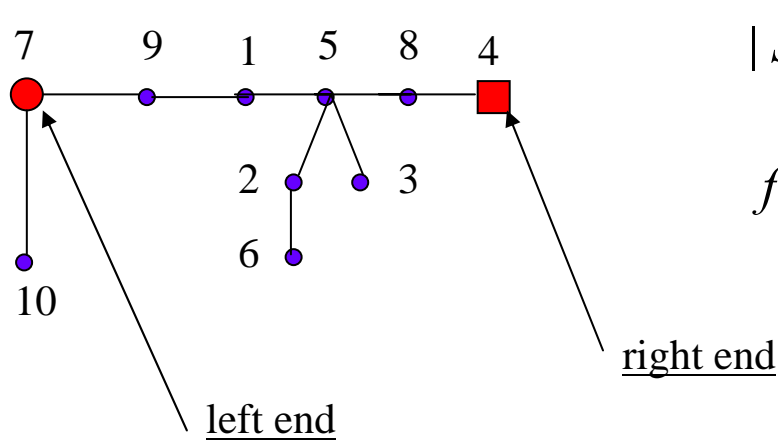

$$|S_n| = n^2 |T_n|$$

$$f : \{1, \dots, n\} \rightarrow \{1, \dots, n\}$$

$$f|_M = \begin{pmatrix} 1 & 4 & 5 & 7 & 8 & 9 \\ 7 & 9 & 1 & 5 & 8 & 4 \end{pmatrix}$$

2. Establishing a 1-1 correspondence between trees and functions acting from 1..n into 1..n (Joyal)

$$f = \begin{pmatrix} 1 & 2 & 3 & 4 & 5 & 6 & 7 & 8 & 9 & 10 \\ 7 & 5 & 9 & 1 & 2 & 5 & 8 & 4 & 7 & 10 \end{pmatrix}$$

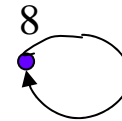
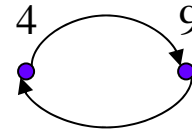
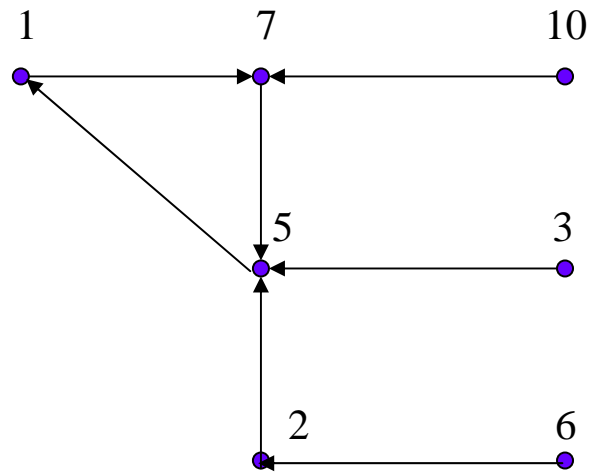

2. Establishing a 1-1 correspondence between trees and functions acting from 1..n into 1..n (Joyal)

$$f = \begin{pmatrix} 1 & 2 & 3 & 4 & 5 & 6 & 7 & 8 & 9 & 10 \\ 7 & 5 & 9 & 1 & 2 & 5 & 8 & 4 & 7 & 3 \end{pmatrix}$$

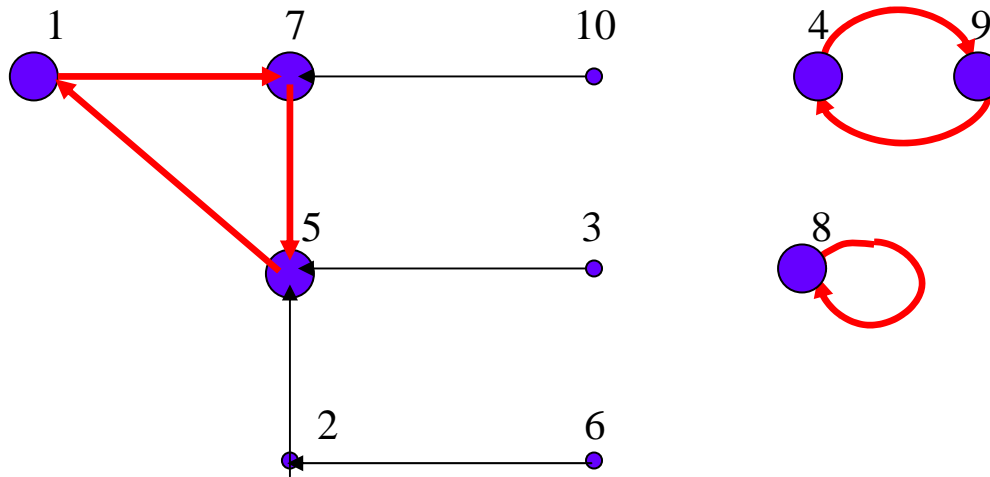

$M = \{1, 4, 5, 7, 8, 9\}$ $f|_M$ is a bijection

2. Establishing a 1-1 correspondence between trees and functions acting from 1..n into 1..n (Joyal)

$$f|_M = \begin{pmatrix} 1 & 4 & 5 & 7 & 8 & 9 \\ 7 & 9 & 1 & 5 & 8 & 4 \end{pmatrix}$$

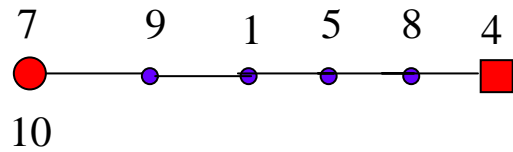

2. Establishing a 1-1 correspondence between trees and functions acting from 1..n into 1..n (Joyal)

$$f|_M = \begin{pmatrix} 1 & 4 & 5 & 7 & 8 & 9 \\ 7 & 9 & 1 & 5 & 8 & 4 \end{pmatrix}$$

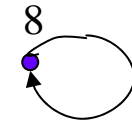
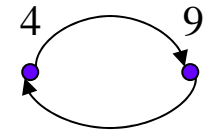
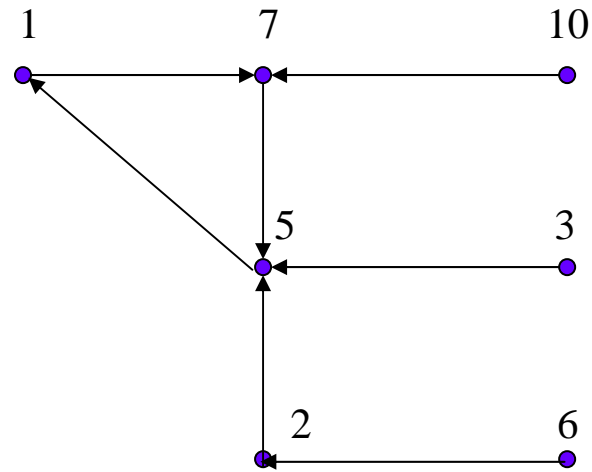
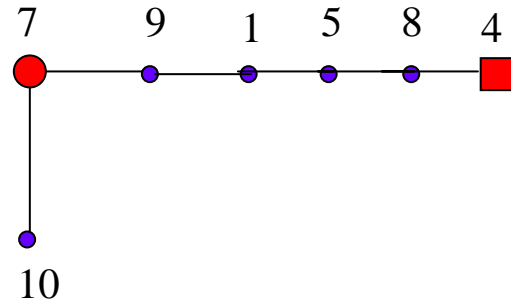

2. Establishing a 1-1 correspondence between trees and functions acting from 1..n into 1..n (Joyal)

$$f|_M = \begin{pmatrix} 1 & 4 & 5 & 7 & 8 & 9 \\ 7 & 9 & 1 & 5 & 8 & 4 \end{pmatrix}$$

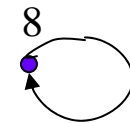
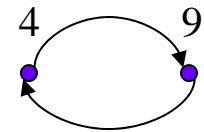
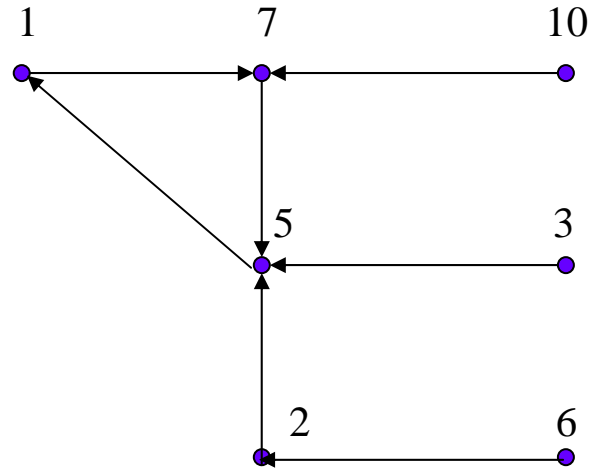
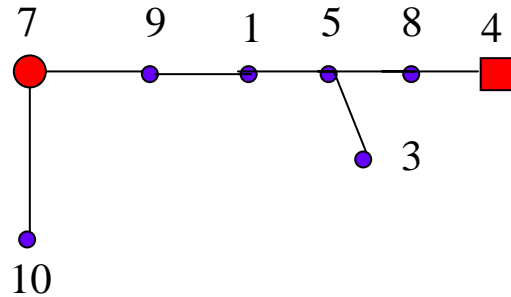

2. Establishing a 1-1 correspondence between trees and functions acting from 1..n into 1..n (Joyal)

$$f|_M = \begin{pmatrix} 1 & 4 & 5 & 7 & 8 & 9 \\ 7 & 9 & 1 & 5 & 8 & 4 \end{pmatrix}$$

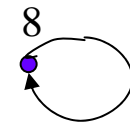
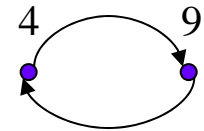
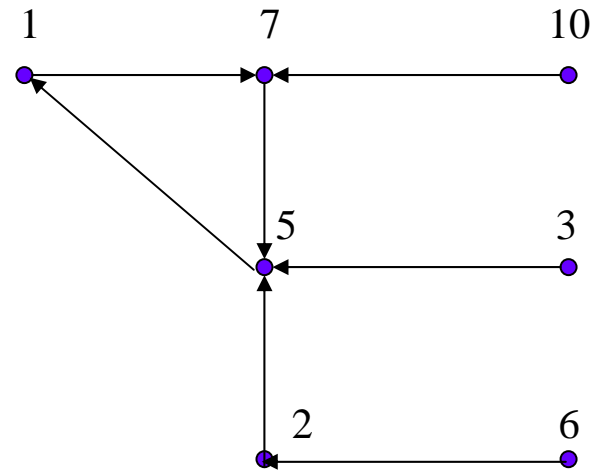
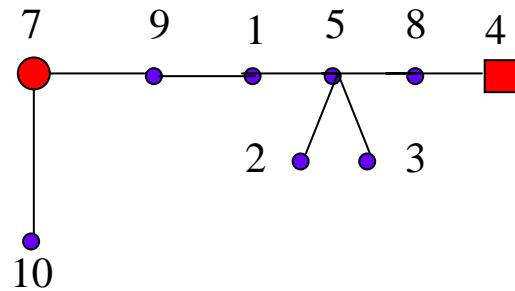

2. Establishing a 1-1 correspondence between trees and functions acting from 1..n into 1..n (Joyal)

$$f|_M = \begin{pmatrix} 1 & 4 & 5 & 7 & 8 & 9 \\ 7 & 9 & 1 & 5 & 8 & 4 \end{pmatrix}$$

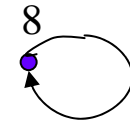
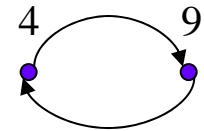
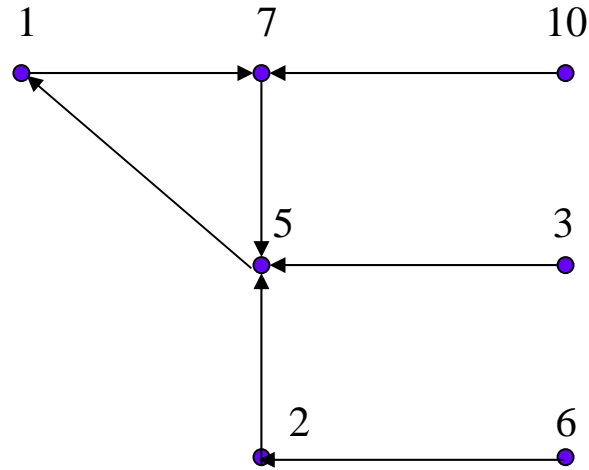
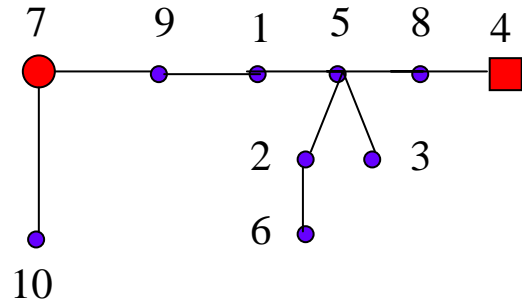

2. Establishing a 1-1 correspondence between trees and functions acting from 1..n into 1..n (Joyal)

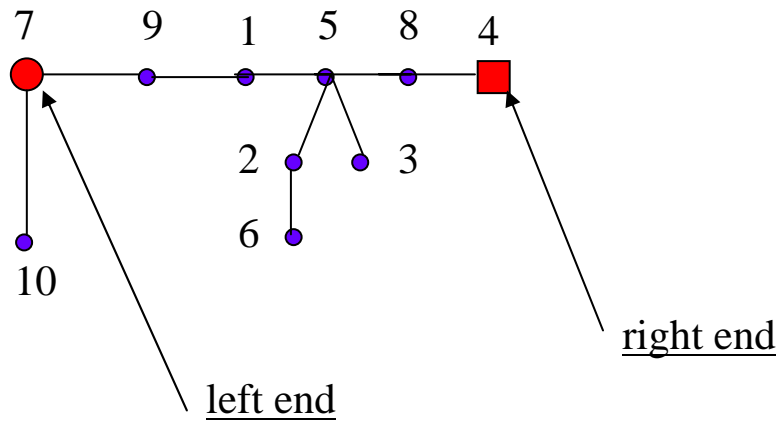

$(7,9,1,5,8,4) \rightarrow (1,5,7,8,4,9)$

$$f = \begin{pmatrix} 1 & 4 & 5 & 7 & 8 & 9 \\ 7 & 9 & 1 & 5 & 8 & 4 \end{pmatrix}$$

2. Pruefer code

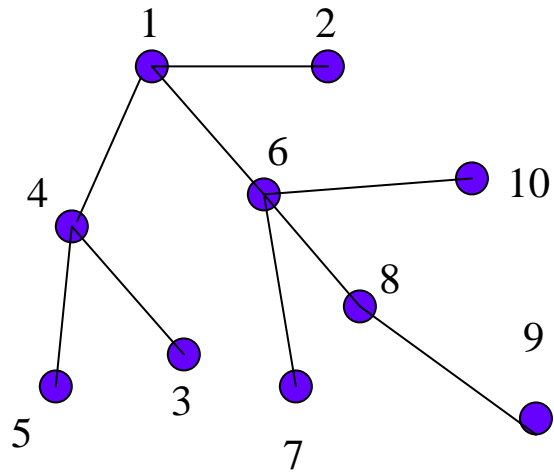

Labeled tree $\rightarrow (a_1, a_2, \dots, a_{n-2})$

2. Pruefer code

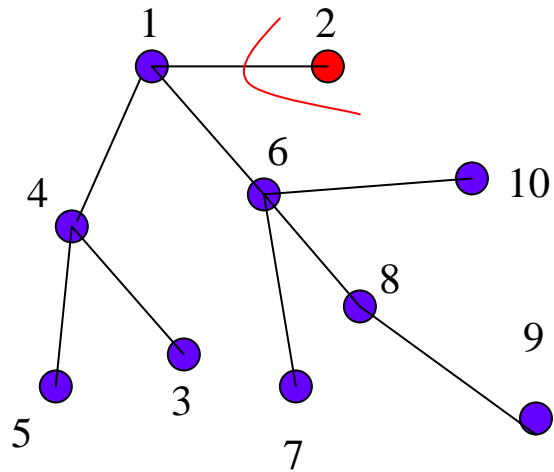

Labeled tree $\rightarrow (a_1, a_2, \dots, a_{n-2})$

Pruefer code : **1**

2. Pruefer code

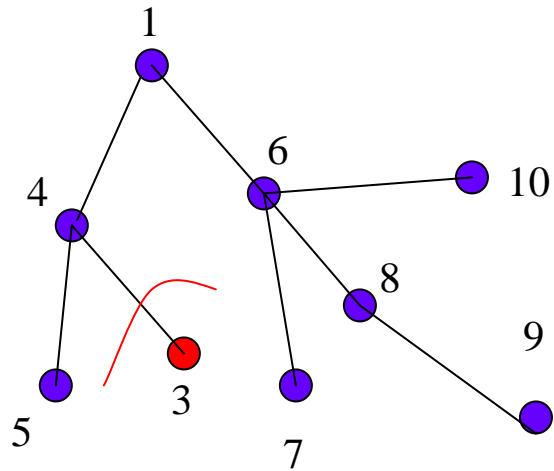

Labeled tree $\rightarrow (a_1, a_2, \dots, a_{n-2})$

Pruefer code : **1 4**

2. Pruefer code

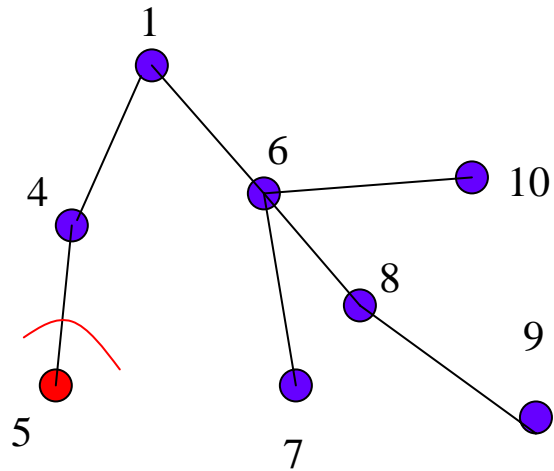

Labeled tree $\rightarrow (a_1, a_2, \dots, a_{n-2})$

Pruefer code : **1 4 4**

2. Pruefer code

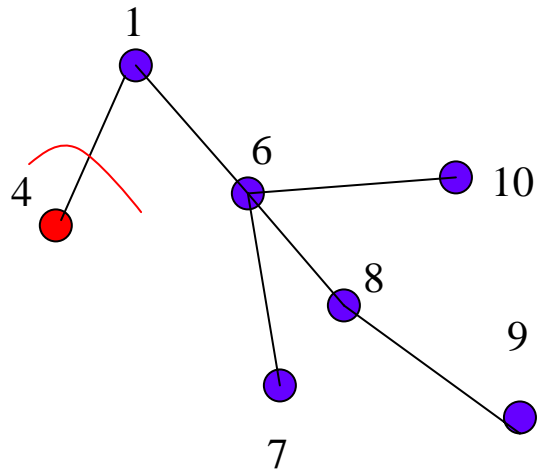

Labeled tree $\rightarrow (a_1, a_2, \dots, a_{n-2})$

Pruefer code : **1 4 4 1**

2. Pruefer code

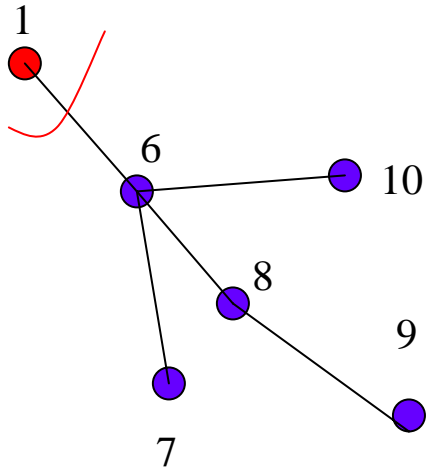

Labeled tree $\rightarrow (a_1, a_2, \dots, a_{n-2})$

Pruefer code : **1 4 4 1 6**

2. Pruefer code

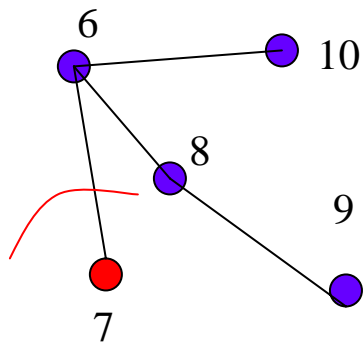

Labeled tree $\rightarrow (a_1, a_2, \dots, a_{n-2})$

Pruefer code : **1 4 4 1 6 6**

2. Pruefer code

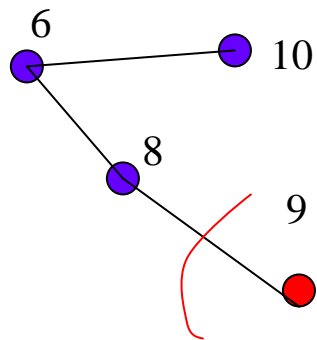

Labeled tree $\rightarrow (a_1, a_2, \dots, a_{n-2})$

Pruefer code : **1 4 4 1 6 6 8**

2. Pruefer code

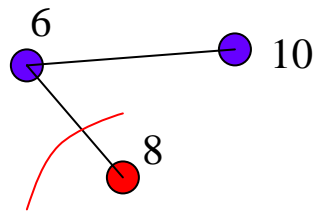

Labeled tree $\rightarrow (a_1, a_2, \dots, a_{n-2})$

Pruefer code : **1 4 4 1 6 6 8 6**

2. Pruefer code

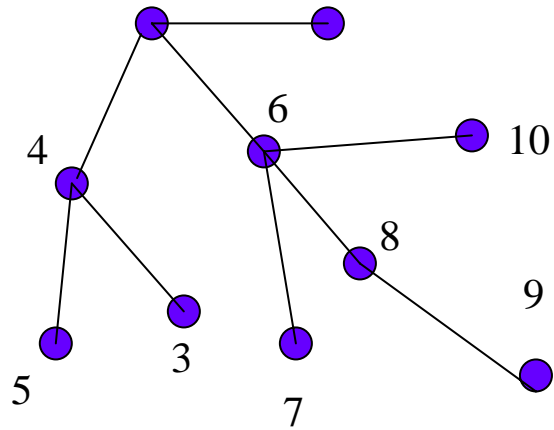

(1 4 4 1 6 6 8 6)

Reversing the correspondence

(1 4 4 1 6 6 8 6)

- - deleted vertex
- - end vertex
- - inner vertex

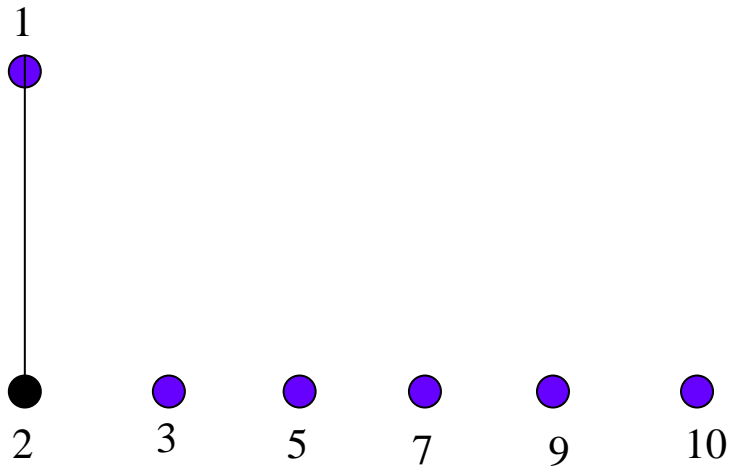

Reversing the correspondence

(1 4 4 1 6 6 8 6)

- - deleted vertex
- - end vertex
- - inner vertex

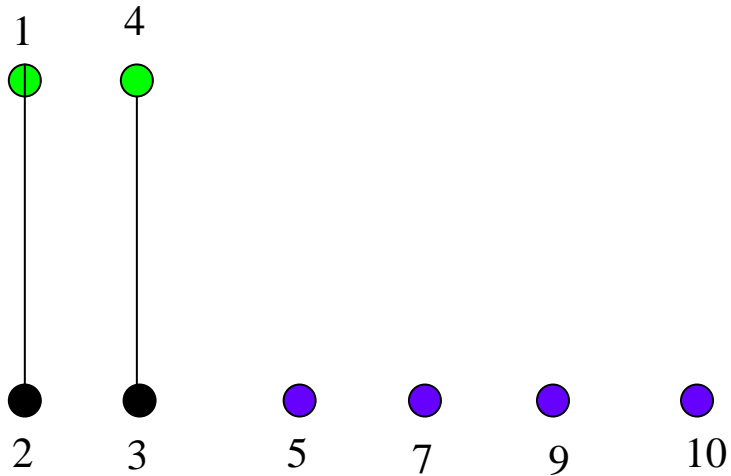

Reversing the correspondence

(1 4 4 1 6 6 8 6)

- - deleted vertex
- - end vertex
- - inner vertex

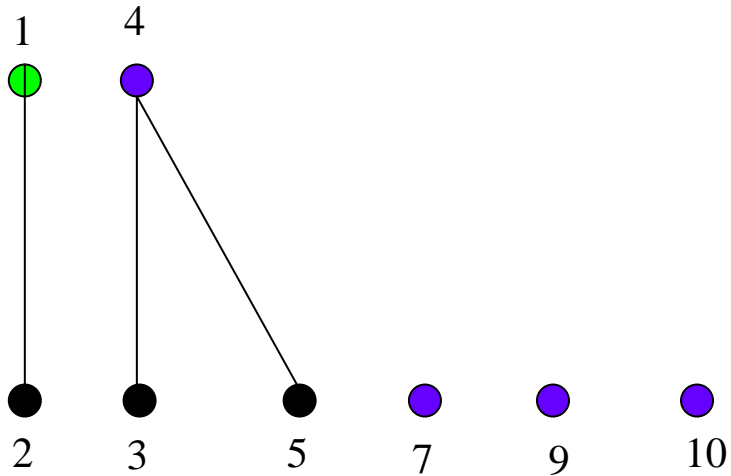

Reversing the correspondence

(1 4 4 1 6 6 8 6)

- - deleted vertex
- - end vertex
- - inner vertex

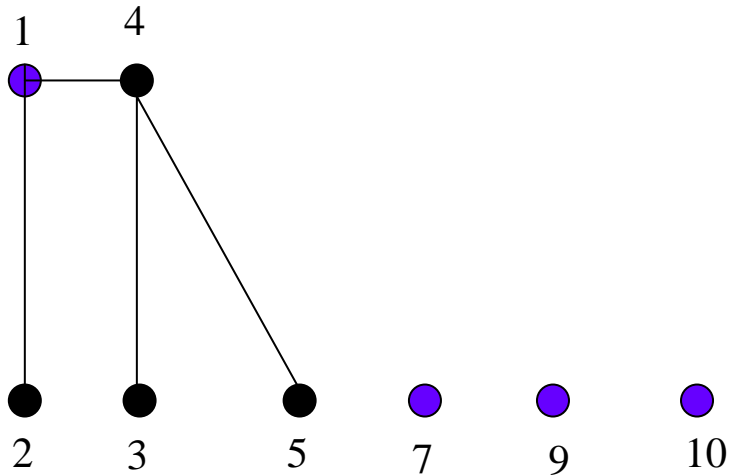

Reversing the correspondence

(1 4 4 1 6 6 8 6)

- - deleted vertex
- - end vertex
- - inner vertex

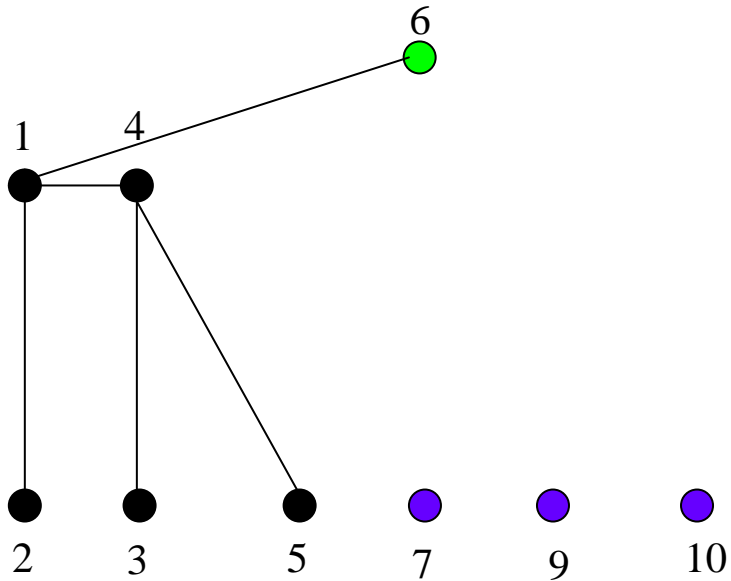

Reversing the correspondence

(1 4 4 1 6 6 8 6)

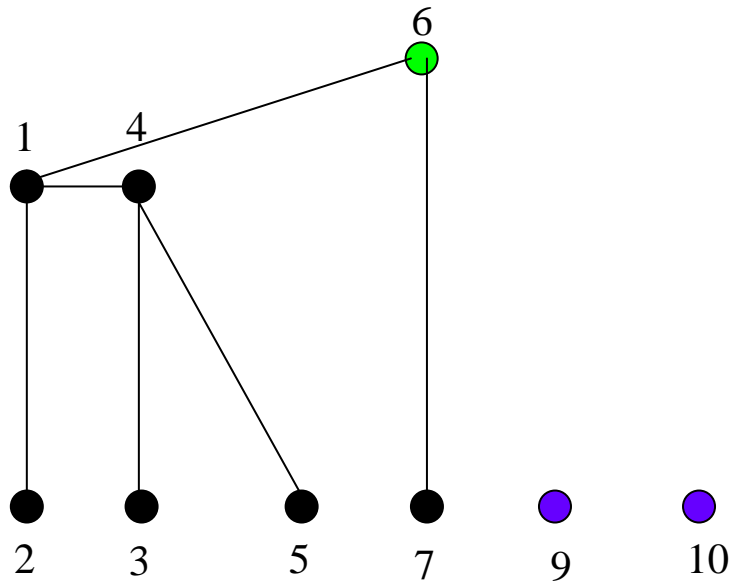

- - deleted vertex
- - end vertex
- - inner vertex

Reversing the correspondence

(1 4 4 1 6 6 8 6)

- - deleted vertex
- - end vertex
- - inner vertex

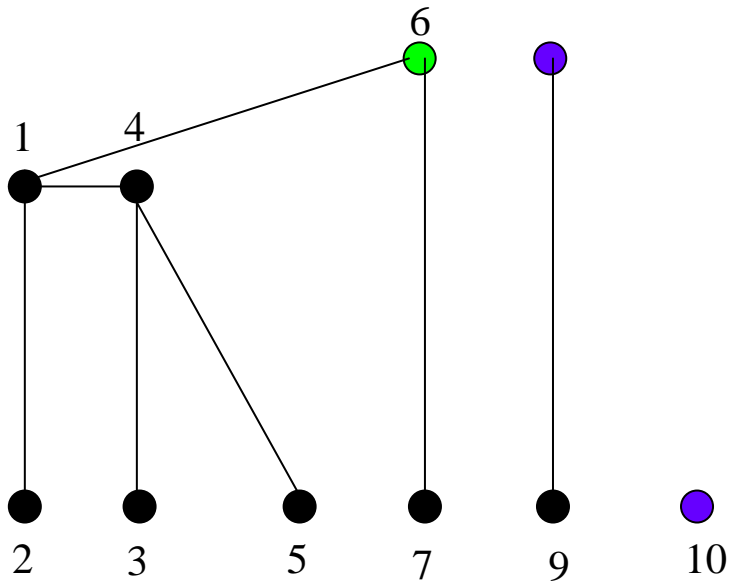

Reversing the correspondence

(1 4 4 1 6 6 8 6)

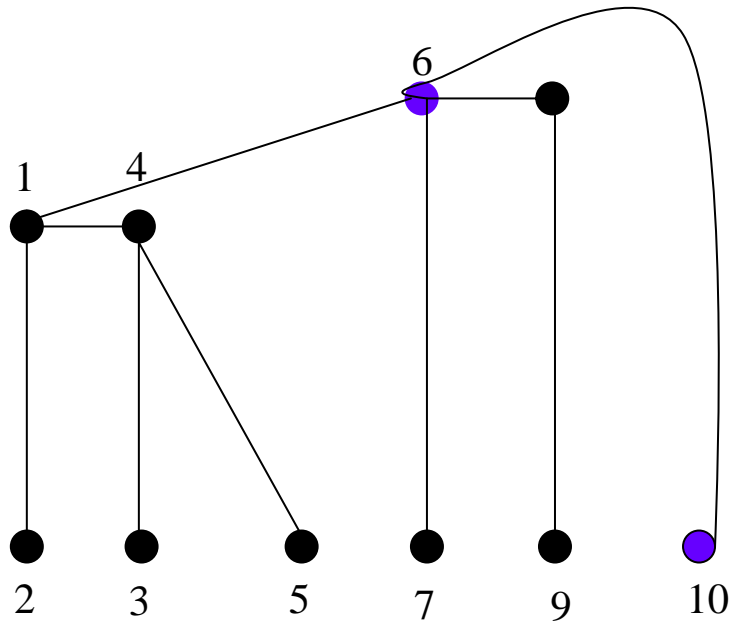

- - deleted vertex
- - end vertex
- - inner vertex

Reversing the correspondence

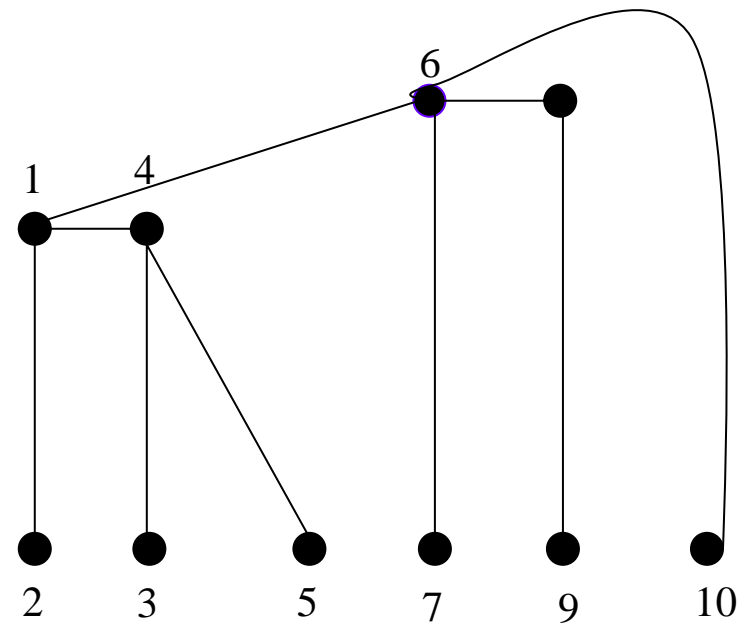
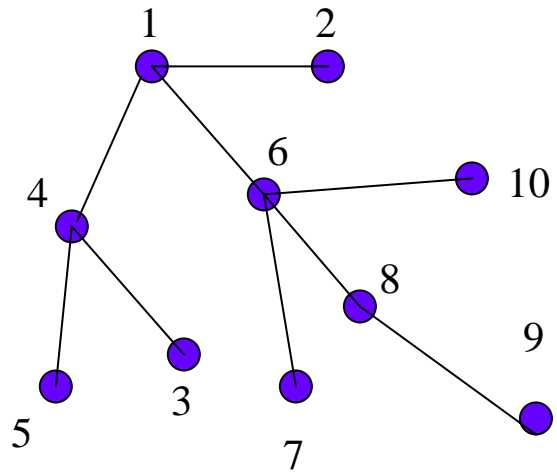

Other applications: the number of trees with a given degree sequence

$$(x_1 + \dots + x_m)^n = \sum_{\substack{(d_1, \dots, d_m) \\ \sum_i d_i = n}} \frac{n!}{d_1! \dots d_m!} x_1^{d_1} \dots x_m^{d_m}$$

Let (d_1, \dots, d_m) be the degree sequence

$$\frac{(n-2)!}{(d_1-1)! \dots (d_m-1)!}$$

Other applications: the number of trees with a given degree sequence

$$(x_1 + \dots + x_m)^n = \sum_{\substack{(d_1, \dots, d_m) \\ \sum_i d_i = n}} \frac{n!}{d_1! \dots d_m!} x_1^{d_1} \dots x_m^{d_m}$$

Let (d_1, \dots, d_n) be the degree sequence

$$\frac{(n-2)!}{(d_1-1)! \dots (d_n-1)!}$$

$$\binom{n-2}{k-1} (n-1)^{n-k-1} \quad \text{-the number of trees in which vertex } n \text{ has degree } k$$

Polya's approach

$$T(x) = \sum_{n=1}^{\infty} nt_n \frac{x^n}{n!}$$

$T(x)$ is the generating function for the number of rooted trees with n vertices

Let c_n be the number of connected graphs on n vertices enjoying a certain property P .

$$\frac{1}{2} \sum_{k=1}^{n-1} \binom{n}{k} \cdot c_k \cdot c_{n-k} = \frac{1}{2} \cdot n! \sum_{k=1}^{n-1} \frac{c_k}{k!} \cdot \frac{c_{n-k}}{(n-k)!}$$

$$C(x) = \sum_{n=1}^{\infty} c_n \frac{x^n}{n!}$$

Polya's approach

$$T(x) = \sum_{n=1}^{\infty} nt_n \frac{x^n}{n!}$$

$T(x)$ is the generating function for the number of rooted trees with n vertices

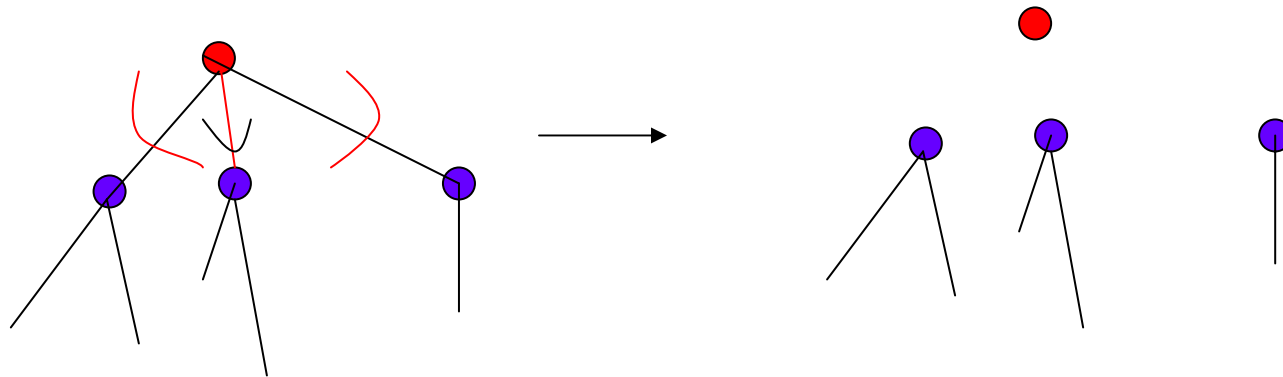

$$T(x) = xe^{T(x)}$$

Lagrange inversion formula

$$\varphi(s) = x\psi(\varphi(s))$$

$$\frac{d^n}{ds^n} \varphi(s) \Big|_{s=0} = \frac{1}{n} \frac{d^n}{dt^n} \psi^n(t) \Big|_{t=0}$$

$$nt_n = \frac{1}{n} \frac{d^n}{dt^n} e^{nt} \Big|_{t=0} = n^{n-1}$$

The number of spanning trees of a directed graph

Def. A spanning tree of a graph G is its subgraph T that includes all the vertices of G and is a tree

Def. A directed tree rooted at vertex n is a tree, all arcs of which are directed towards the root

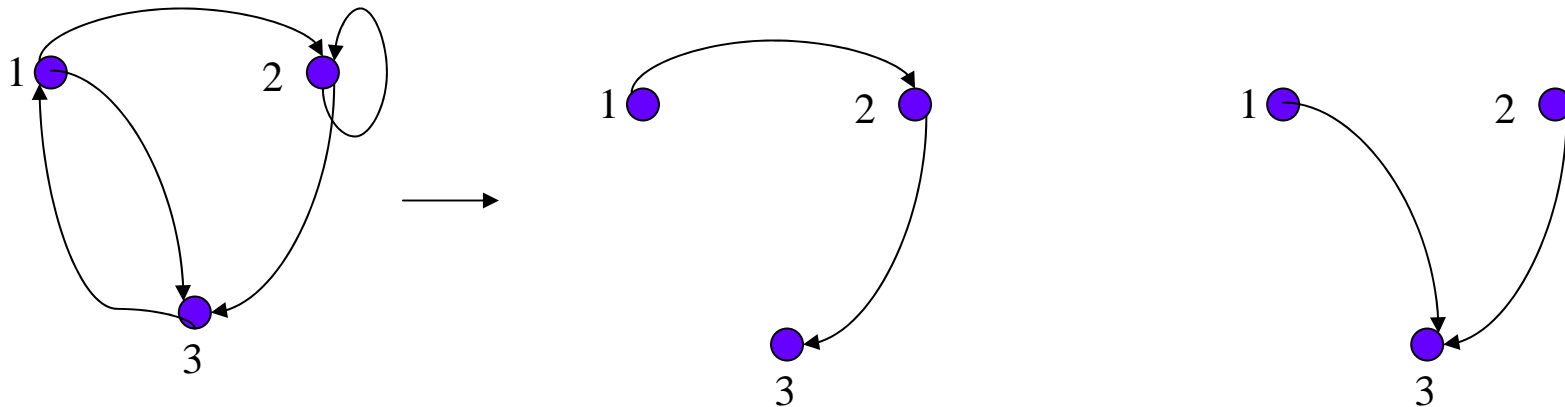

Knuth's theorem

$$n = \sum_{j=1}^h s_j$$

Consider an example: $s_1 = 3, s_2 = 2, s_3 = 2$

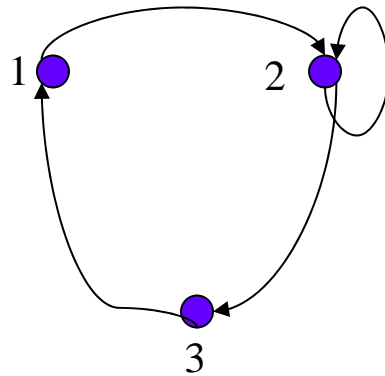

Knuth's theorem

$$n = \sum_{j=1}^h s_j$$

Consider an example: $s_1 = 3, s_2 = 2, s_3 = 2$

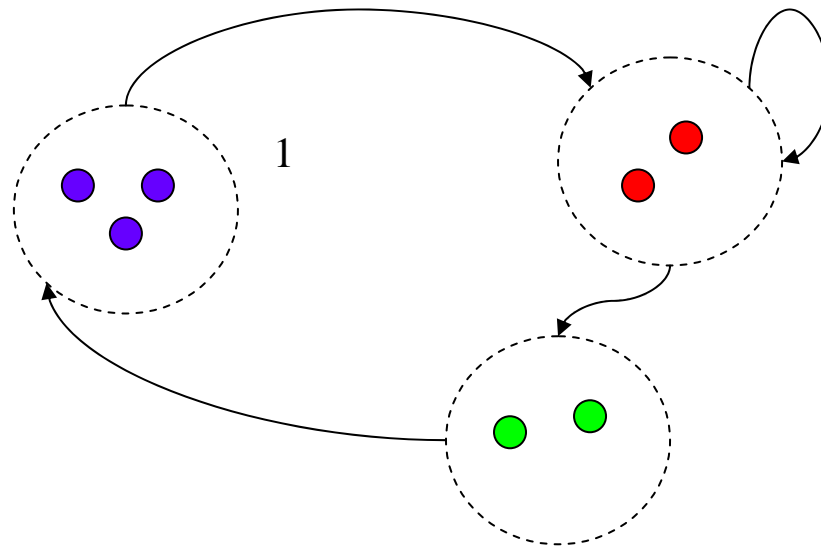

Knuth's theorem

$$n = \sum_{j=1}^h s_j$$

Consider an example:

$$s_1 = 3, s_2 = 2, s_3 = 2$$

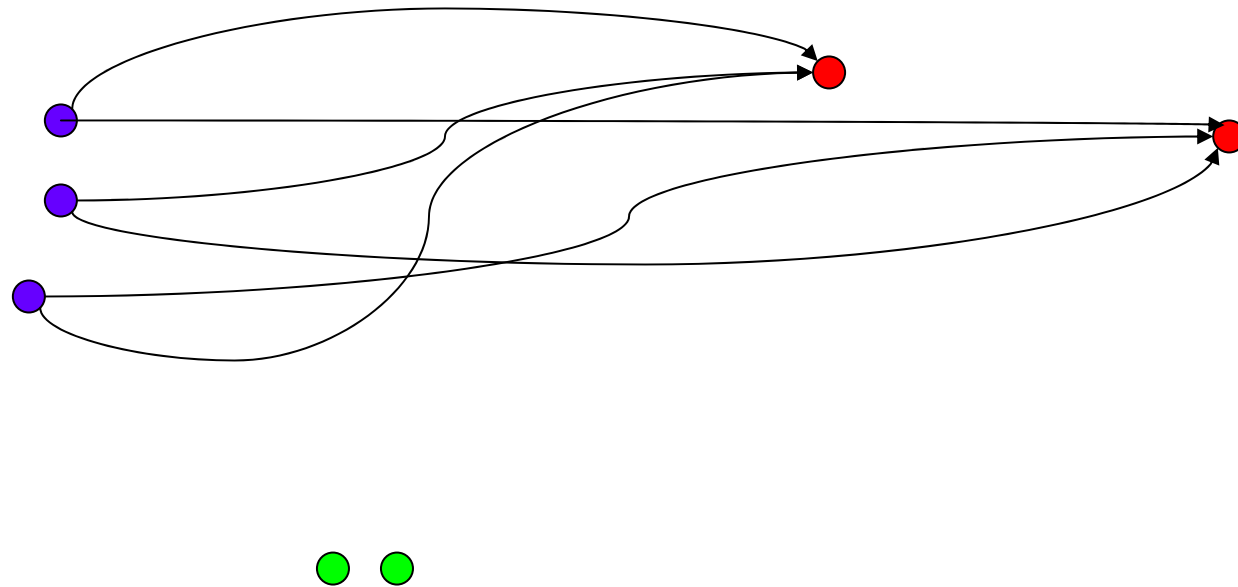

Knuth's theorem

$$n = \sum_{j=1}^h s_j$$

Consider an example:

$$s_1 = 3, s_2 = 2, s_3 = 2$$

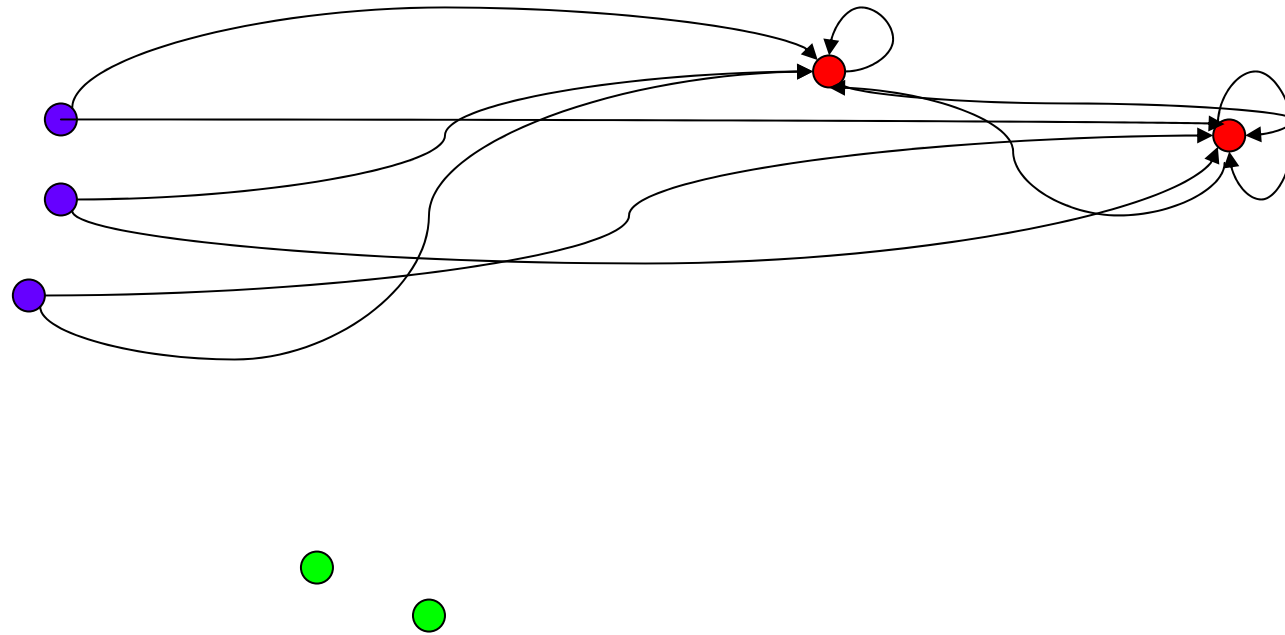

Knuth's theorem

$$n = \sum_{j=1}^h s_j$$

Consider an example:

$$s_1 = 3, s_2 = 2, s_3 = 2$$

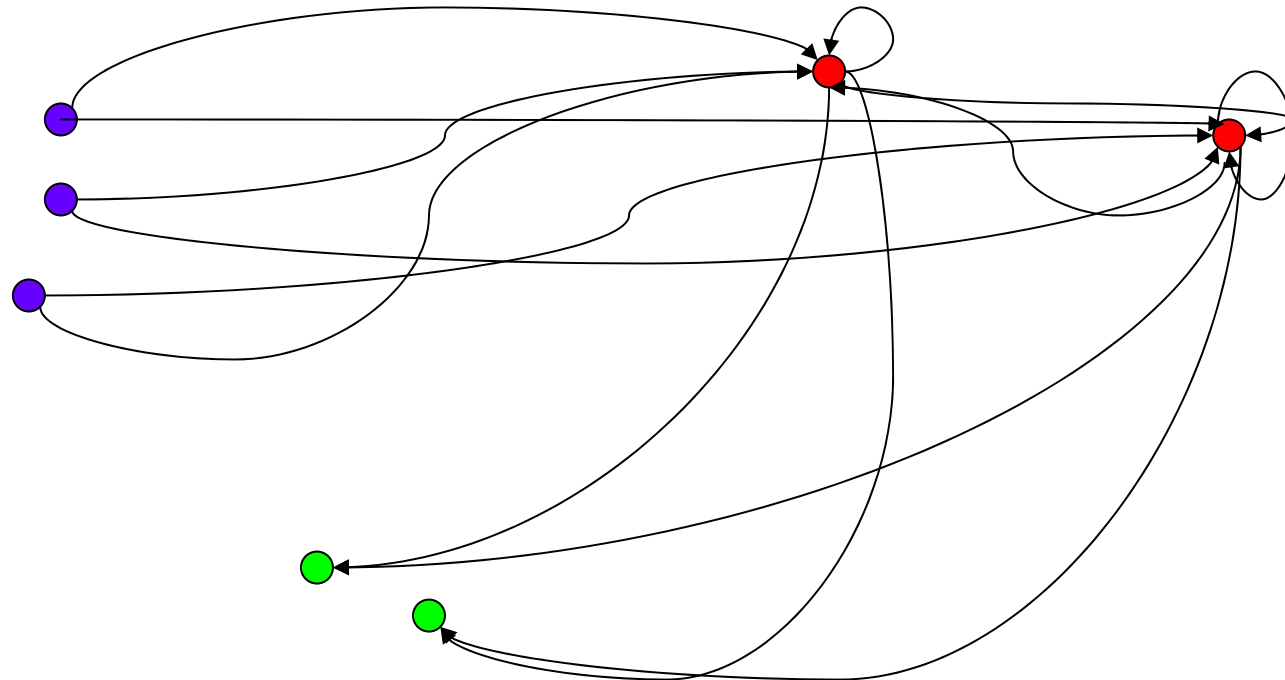

Knuth's theorem

$$n = \sum_{j=1}^h s_j$$

Consider an example:

$$s_1 = 3, s_2 = 2, s_3 = 2$$

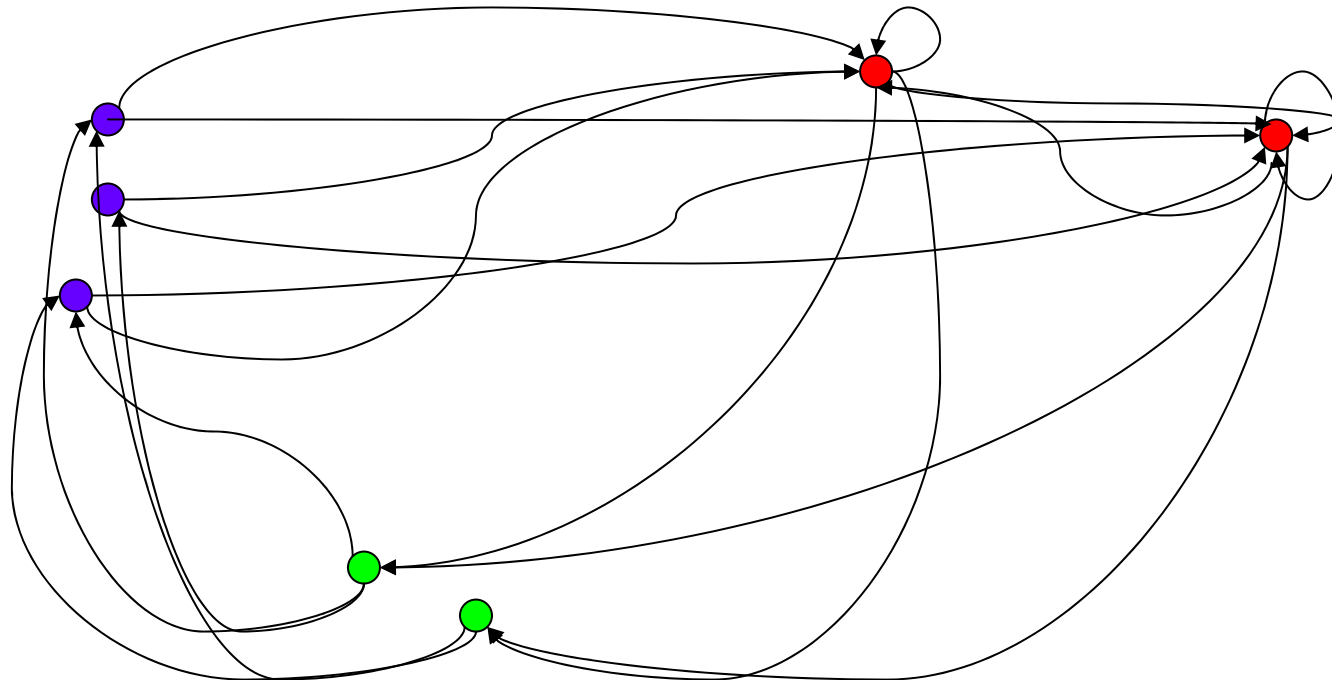

Knuth's theorem

Def. A function f is called a tree function of a directed tree T iff $f(i)=j$ when j is the first vertex on the way from i to the root.

Let $c(H)$ denote the number of spanning trees of the graph H

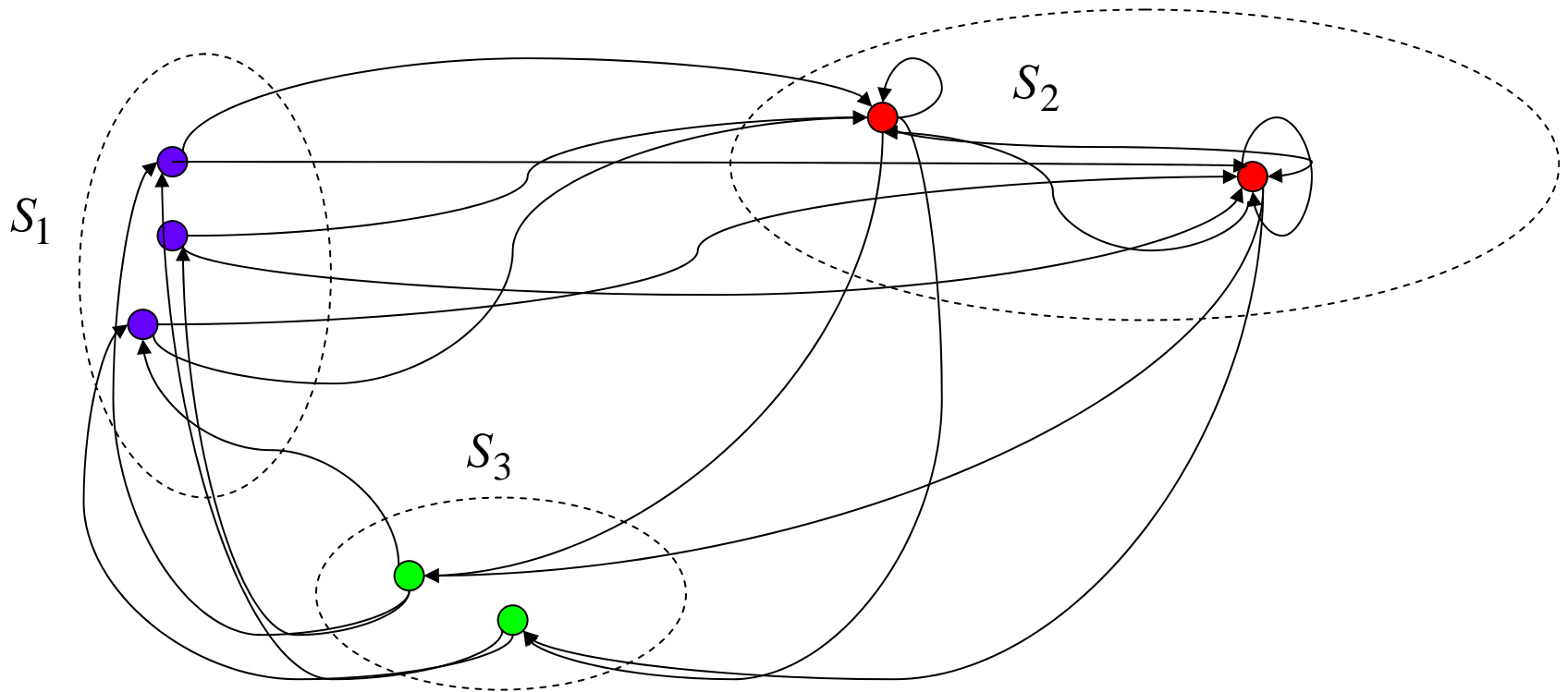

Knuth's theorem

Theorem (Knuth) $c(H) = \sum_{f \text{ i=1}}^{h-1} \prod |\Gamma(S_i)|^{|S_i|-1} |f(S_i)|$

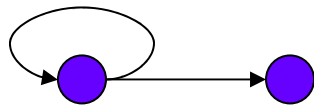

Theorem The number of spanning trees of a graph H arisen from a directed cycle equals

$$s_2^{s_1-1} \cdot s_3^{s_2} \cdot s_4^{s_3} \cdot \dots \cdot s_1^{s_h-1}$$

Knuth's theorem

Theorem The number of spanning trees of a graph H arisen from a directed cycle equals

$$s_2^{s_1-1} \cdot s_3^{s_2} \cdot s_4^{s_3} \cdot \dots \cdot s_1^{s_h-1}$$

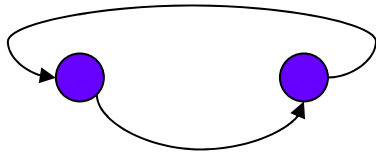

$s_2^{s_1-1} \cdot s_1^{s_2-1}$ is the number of r by s bipartite graphs

Knuth's theorem

$$\sum_{k=0}^n \binom{n}{k} k^{n-k-1} (n-k-1)^{k-1} = 2n^{n-2}$$

Matrix-Tree Theorem

Def. Let G be a directed graph without loops. Let $\{v_1, \dots, v_n\}$ denote the vertices of G , and $\{e_1, \dots, e_m\}$ denote the edges of G .

The incidence matrix of G is the $n \times m$ matrix A , such that

$$a_{i,j} = 1, \quad \text{if } v_i \text{ is the head of } e_j$$

$$a_{i,j} = -1, \quad \text{if } v_i \text{ is the tail of } e_j$$

$$a_{i,j} = 0 \quad \text{otherwise}$$

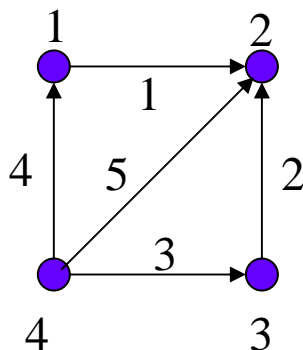

+1	0	0	-1	0
-1	-1	0	0	-1
0	+1	-1	0	0
0	0	+1	+1	+1

Matrix-Tree Theorem

Lemma. The incidence matrix of a connected graph on n vertices has the rank of $n-1$

The *reduced incidence matrix* A of a connected graph G is the matrix obtained from the incidence matrix by deleting a certain row.

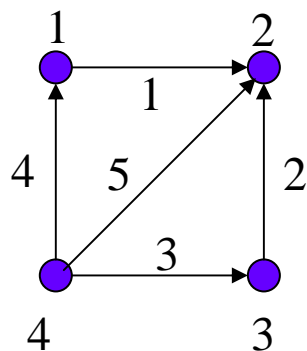

+1	0	0	-1	0
-1	-1	0	0	-1
0	+1	-1	0	0
0	0	+1	+1	+1

Matrix-Tree Theorem

Lemma. The incidence matrix of a connected graph on n vertices has the rank of $n-1$

The *reduced incidence matrix* A of a connected graph G is the matrix obtained from the incidence matrix by deleting a certain row.

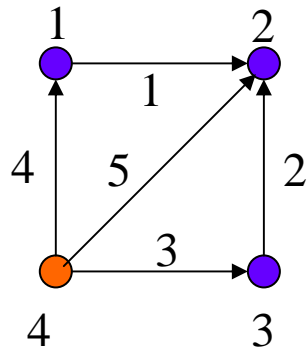

$$\begin{matrix}
 +1 & 0 & 0 & -1 & 0 \\
 -1 & -1 & 0 & 0 & -1 \\
 0 & +1 & -1 & 0 & 0
 \end{matrix}$$

Matrix-Tree Theorem

Lemma. The incidence matrix of a connected graph on n vertices has the rank of $n-1$

The *reduced incidence matrix* A of a connected graph G is the matrix obtained from the incidence matrix by deleting a certain row.

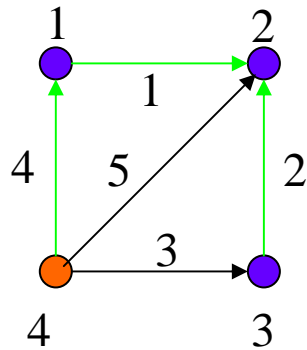

$$\begin{matrix} +1 & 0 & -1 \\ -1 & -1 & 0 \\ 0 & +1 & 0 \end{matrix}$$

Matrix-Tree Theorem

Lemma. The incidence matrix of a connected graph on n vertices has the rank of $n-1$

The *reduced incidence matrix* A of a connected graph G is the matrix obtained from the incidence matrix by deleting a certain row.

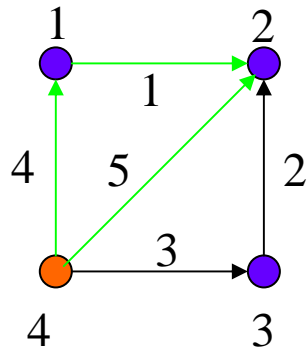

$$\begin{matrix} +1 & -1 & 0 \\ -1 & 0 & -1 \\ 0 & 0 & 0 \end{matrix}$$

Matrix-Tree Theorem

Let A_0 be the reduced incidence matrix of the graph G .

Theorem (Binet-Cauchy)

If R and S are matrices of size p by q and q by p , where $p \leq q$, then

$$\det(RS) = \sum \det(B) \cdot \det(C)$$

Theorem (Matrix-Tree Theorem)

If A is a reduced incidence matrix of the graph G , then the number of spanning trees equals $\det(A \cdot A^T)$

$$\det A \cdot A^T = \sum (\det B)^2$$

Matrix-Tree Theorem

e_1, \dots, e_b – variables identified with edges of G

$$M(e) = [m_{ij}]$$

$m_{ij} = -e_k$, if e_k joins i and j and $i \neq j$

$m_{ij} = \text{sum}$ if edges incident to i otherwise

Theorem $M_n(e) = \sum \Pi(T)$

$$M_4(e) = \begin{vmatrix} e_1 + e_4 & -e_1 & 0 \\ -e_1 & e_1 + e_2 + e_5 & -e_2 \\ 0 & -e_2 & e_2 + e_3 \end{vmatrix} =$$

$$= e_1 e_2 e_3 + e_1 e_2 e_4 + e_1 e_2 e_5 + e_1 e_3 e_4 + e_1 e_3 e_5 + e_2 e_3 e_4 + e_2 e_4 e_5 + e_3 e_4 e_5$$

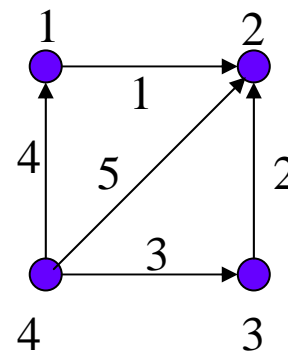

Matrix-Tree Theorem

e_1, \dots, e_b – variables identified with edges of G

$$M(e) = [m_{ij}]$$

$m_{ij} = -e_k$, if e_k joins i and j and $i \neq j$

$m_{ij} = \text{sum}$ if edges incident to i otherwise

Theorem $M_n(e) = \sum \Pi(T)$

$$M_n(e) = \det(A \cdot Y \cdot A^T)$$

$$M_4(e) = \begin{vmatrix} e_1 + e_4 & -e_1 & 0 \\ -e_1 & e_1 + e_2 + e_5 & -e_2 \\ 0 & -e_2 & e_2 + e_3 \end{vmatrix} =$$

$$= e_1 e_2 e_3 + e_1 e_2 e_4 + e_1 e_2 e_5 + e_1 e_3 e_4 + e_1 e_3 e_5 + e_2 e_3 e_4 + e_2 e_4 e_5 + e_3 e_4 e_5$$

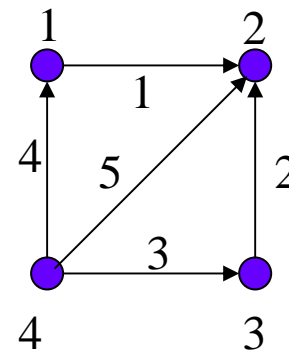

Matrix-Tree Theorem

Another derivation of Cayley's formula:

$$\begin{vmatrix} n-1 & -1 & \dots & -1 & -1 \\ -1 & n-1 & \dots & -1 & -1 \\ -1 & -1 & \ddots & -1 & -1 \\ -1 & -1 & -1 & n-1 & -1 \\ -1 & -1 & -1 & -1 & n-1 \end{vmatrix}$$

Matrix-Tree Theorem

Another derivation of Cayley's formula:

$$\begin{vmatrix} 1 & 1 & \dots & 1 & 1 \\ -1 & n-1 & \dots & -1 & -1 \\ -1 & -1 & \ddots & -1 & -1 \\ -1 & -1 & -1 & n-1 & -1 \\ -1 & -1 & -1 & -1 & n-1 \end{vmatrix}$$

Matrix-Tree Theorem

Another derivation of Cayley's formula:

$$\begin{vmatrix} 1 & 1 & \dots & 1 & 1 \\ 0 & n & \dots & 0 & 0 \\ 0 & 0 & \ddots & 0 & 0 \\ 0 & 0 & 0 & n & 0 \\ 0 & 0 & 0 & 0 & n \end{vmatrix} = n^{n-2}$$

Matrix-Tree Theorem

Theorem (Matrix-Tree Theorem for directed graphs)

Let e_i be variables representing the arcs of the graph. Let $C = [c_{ij}]$ denote the n by n matrix in which $-c_{ij}$ equals the sum of arcs directed from node i to node j if $i \neq j$, and c_{ii} equals the sum of all arcs directed from node i to all other nodes.

Then

$$C_n = \sum \Pi(T),$$

where the summation is over all spanning subtrees of G rooted at node n .

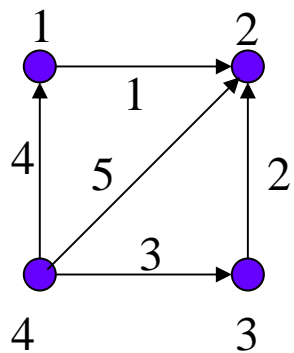

$$C_n = \begin{pmatrix} e_1 & -e_1 & 0 & 0 \\ 0 & 0 & 0 & 0 \\ 0 & -e_2 & e_2 & 0 \\ -e_4 & -e_5 & -e_3 & e_3 + e_4 + e_5 \end{pmatrix}$$

Matrix-Tree Theorem

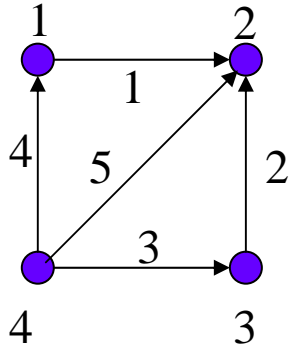

$$C_2 = \begin{vmatrix} e_1 & 0 & 0 \\ 0 & e_2 & 0 \\ -e_4 & -e_3 & e_3 + e_4 + e_5 \end{vmatrix} = e_1 e_2 e_3 + e_1 e_2 e_4 + e_1 e_2 e_5$$