

Investigations on current mills and wind turbines

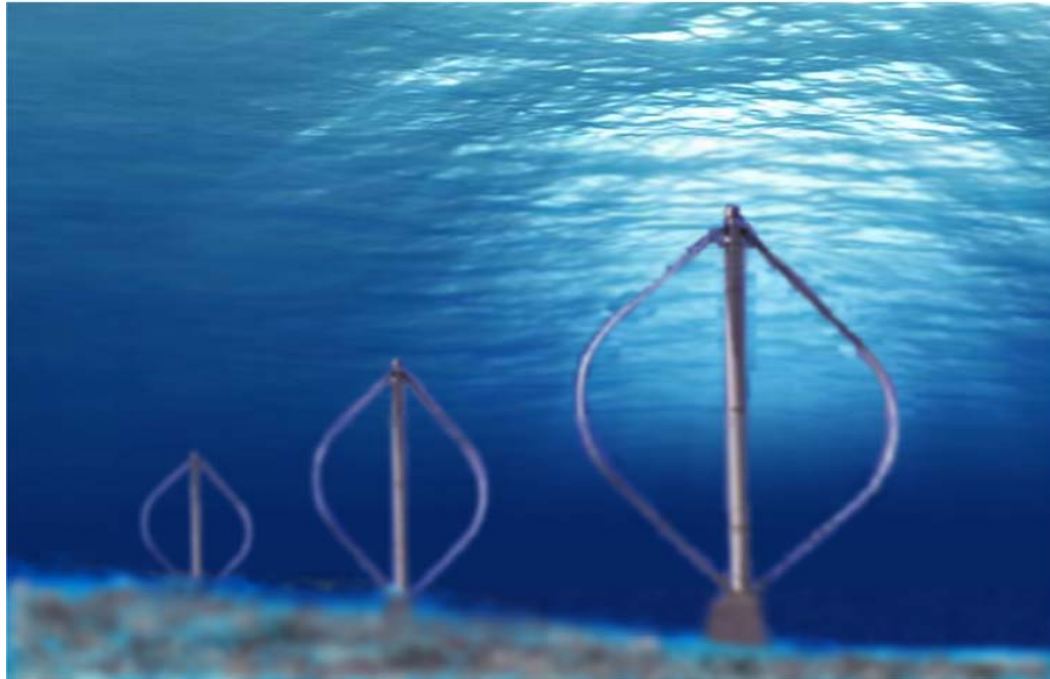

Theodor Beisheim
JASS 2008
St. Petersburg
March 9th -19th 2008

Investigations on current mills and wind turbines

- ➔ **Introduction**
- ➔ **Boundary Conditions**
 - ➔ wind vs. tidal currents
- ➔ **Theory of energy conversion**
 - ➔ Betz' theory
 - ➔ airfoil theory – lift and drag
- ➔ ***vertical axis free stream turbines***
 - ➔ vertical vs. horizontal axis
 - ➔ drag vs. lift based designs
 - ➔ analytical modell for lift based design – problems
 - ➔ pitch-variable design – use of drag
 - ➔ computational methods for drag based design at low TSR

Introduction

- The energy situation is getting more difficult

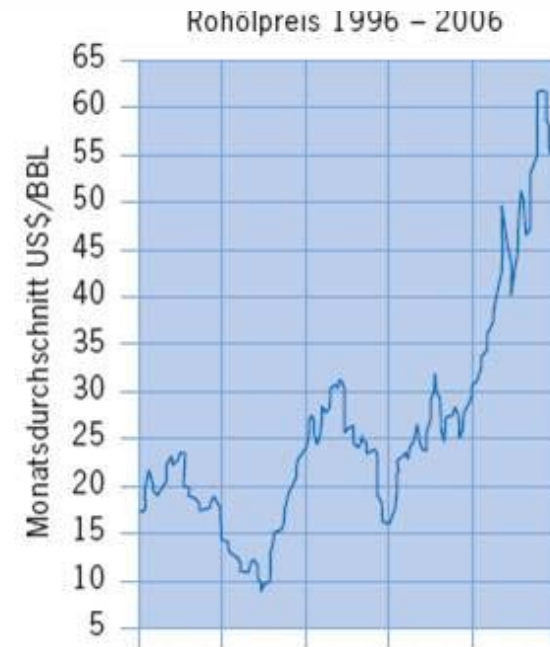

- the will to reduce greengas emissions

Introduction

possible alternatives:

- e.g. nuclear power
- renewable energy resources

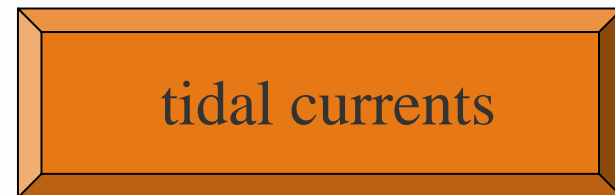
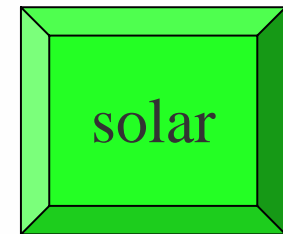
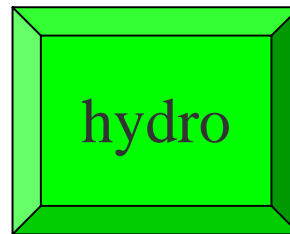
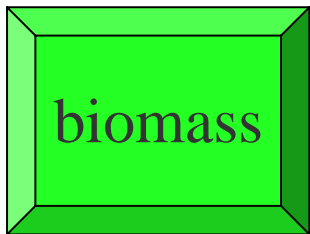

Introduction

wind generation:

- due to geographical differences, there are developing areas of our atmosphere of higher and some of lower pressure

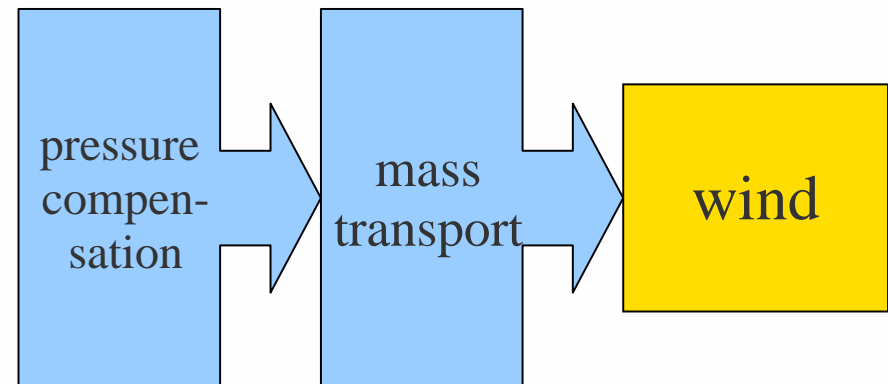
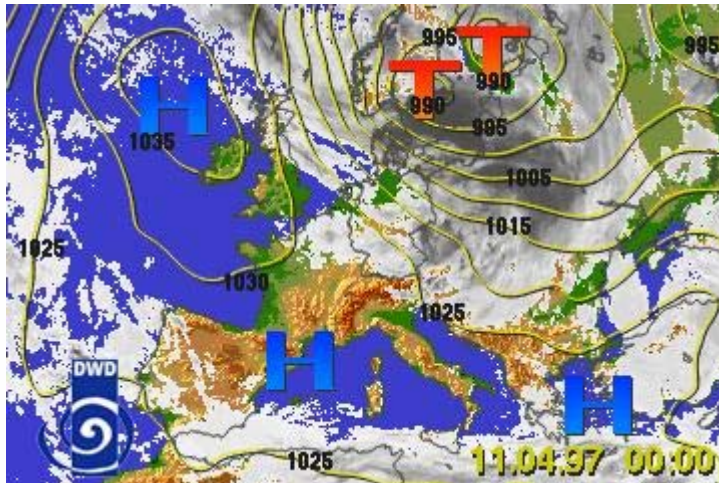

Introduction

development of tidal currents: - cyclic changes in the sea level
- due to gravitation forces in the interplanetary system Sun – Moon - Earth

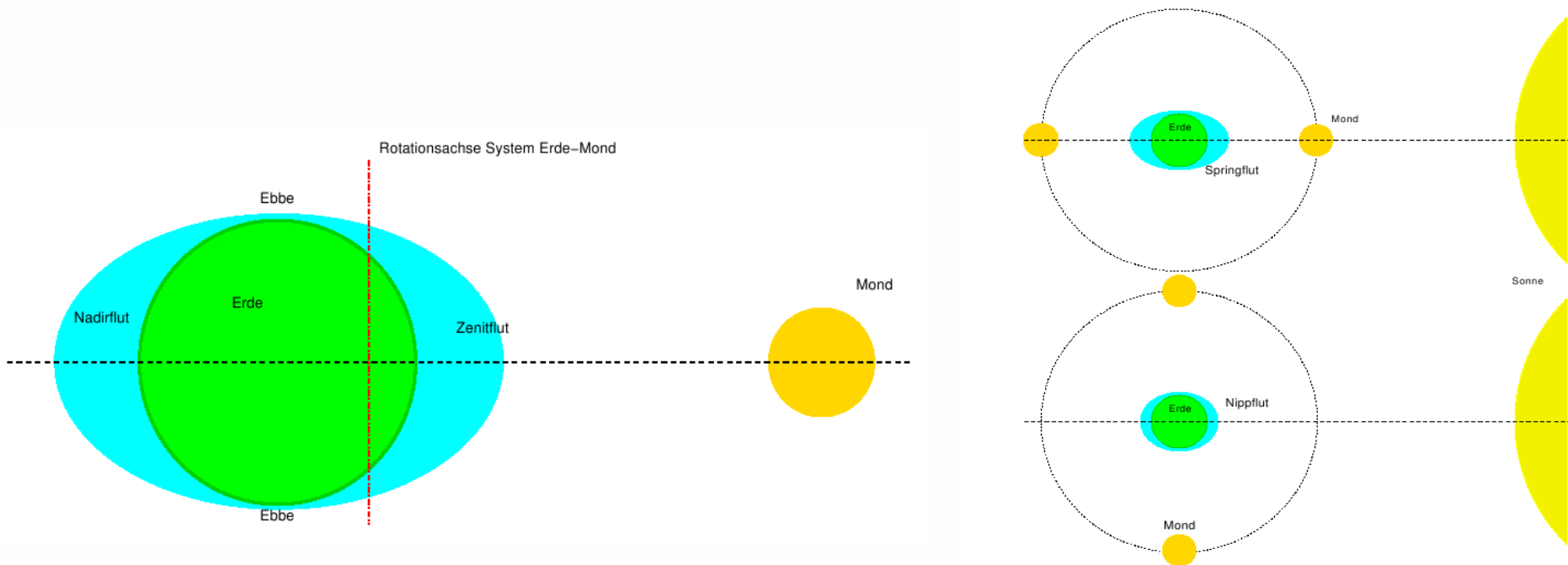

Introduction

examples:

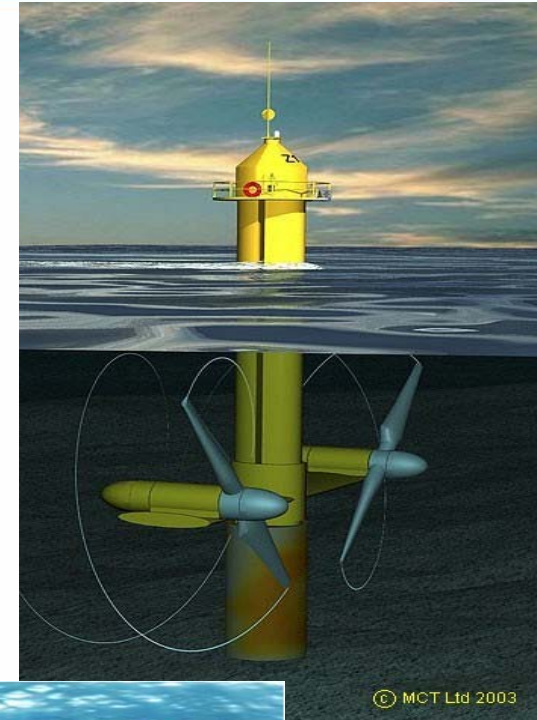

Investigations on current mills and wind turbines

- **Introduction**
- **Boundary Conditions**
 - wind vs. tidal currents
- **Theory of energy conversion**
 - Betz' theory
 - airfoil theory – lift and drag
- ***vertical axis free stream turbines***
 - vertical vs. horizontal axis
 - drag vs. lift based designs
 - analytical modell for lift based design – problems
 - pitch-variable design – use of drag
 - computational methods for drag based design at low TSR

boundary conditions

wind vs. tidal currents:

	wind	tidal currents
density ρ	1,2 kg/m ³	1000-1020 kg/m ³
viscosity η	0,0000171 N/(m ² s)	0,001 N/(m ² s)
velocity v	10 m/s	2 – 3 m/s
Re	300000	450000

$$Re = \rho \cdot v \cdot L \cdot \eta^{-1}$$

Boundary conditions

wind vs tidal currents

- same Re – numbers in wind and water:

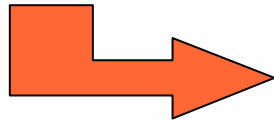

we can use technologies proved in wind energy to convert energy of tidal

streams

- **water and wind streams through free stream turbines can both be calculated incompressible**



Boundary conditions

major advantage of tidal currents in comparison to wind streams:

- cyclic variation of sealevel and the velocity of the stream are **predictable**

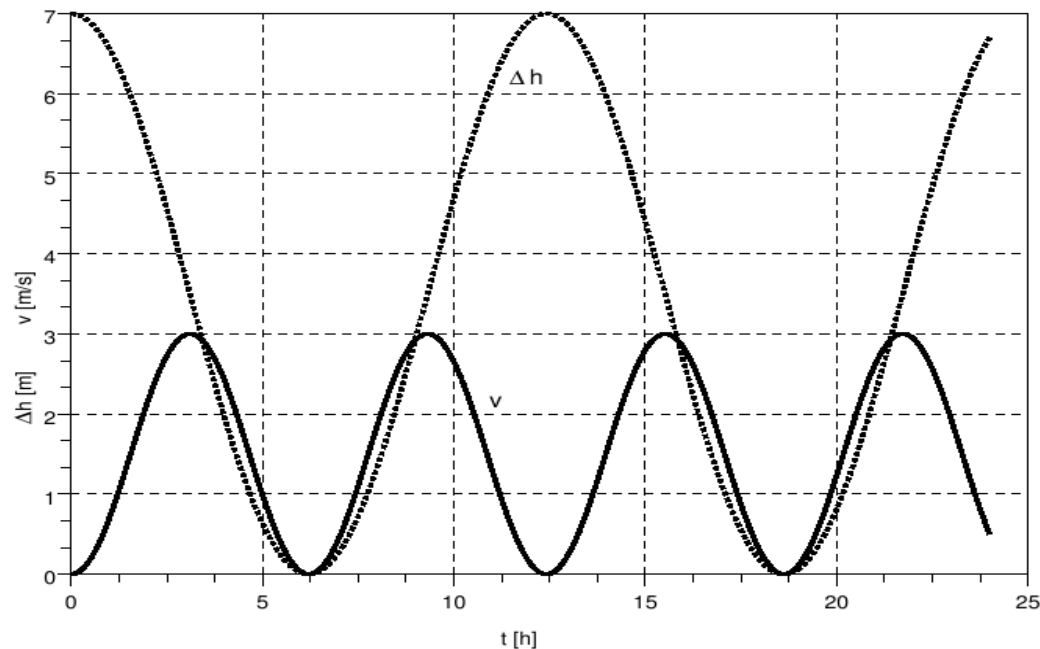

Boundary conditions

boundary layer:

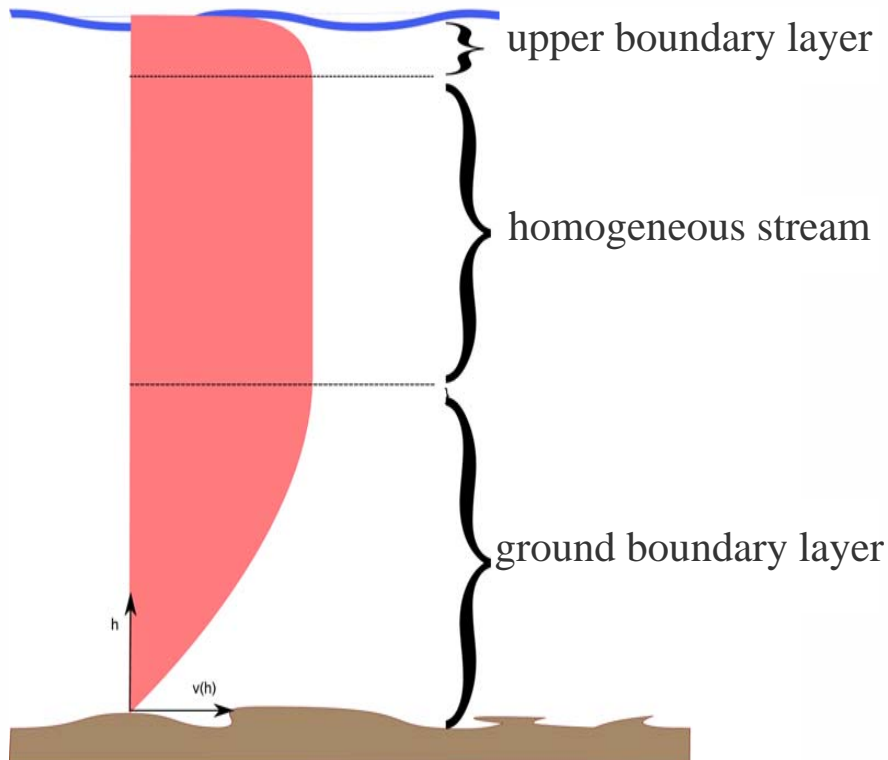

-influences of surface roughness to the velocity profile

- vertical energy transfer leads to turbulence

- at the ground : $v|_{z=z_0} = 0$

- second boundary layer water-air !

Boundary conditions

conclusions:

- direction of the stream changes twice a day
- machine should not be sensitive to see level change / vertical velocity change

possible solution:

- *vertical axis free stream turbine*
- converts power from every stream direction
- this compensates the lower efficiency
- generator and transmission could be built over the water surface

Investigations on current mills and wind turbines

- **Introduction**
- **Boundary Conditions**
 - wind vs. tidal currents
- **Theory of energy conversion**
 - Betz' theory
 - airfoil theory – lift and drag
- ***vertical axis free stream turbines***
 - vertical vs. horizontal axis
 - drag vs. lift based designs
 - analytical modell for lift based design – problems
 - pitch-variable design – use of drag
 - computational methods for drag based design at low TSR

theory of energy conversion

Betz' theory:

total wind power through a control area A :

$$P_{wind} = \frac{dE_{wind}}{dt} = \frac{d}{dt} \left(\frac{1}{2} m v_{\infty}^2 \right) = \frac{1}{2} \rho A v_{\infty}^3$$

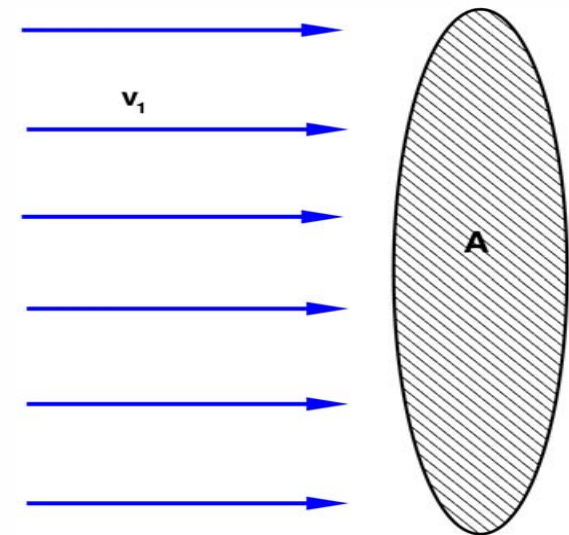
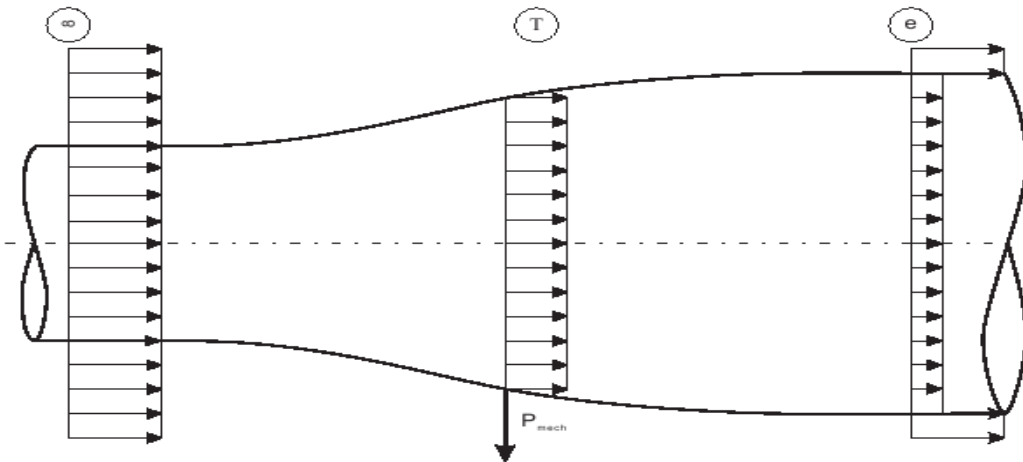

Equation of Continuity:

$$\rho v_1 A_1 = \rho v_2 A_2 = \rho v_3 A_3$$

Energy balance:

$$\Delta E = E_1 - E_3 = \frac{1}{2} m (v_1^2 - v_3^2)$$

theory of energy conversion

Betz' theory:

Power extracted in the Turbine area: $P_{turbine} = \dot{E} = \frac{1}{2} \dot{m}(v_1^2 - v_3^2)$

mass flow rate through the turbine: $\dot{m} = \rho v_2 A_2$

with $v_2 = \frac{v_1 + v_3}{2}$ **Froude-Rankine-theorem**

Power extracted by the turbine: $\dot{E} = \frac{1}{2} \rho \frac{v_1 + v_3}{2} A_2 (v_1 + v_3) (v_1 - v_3)$

in relation to the windenergy: $\dot{E} = \underbrace{\frac{1}{2} \rho A_2 v_1^3}_{P_{wind}} \underbrace{\frac{1}{2} \left(1 + \frac{v_3}{v_1} - \frac{v_3^2}{v_1^2} - \frac{v_3^3}{v_1^3} \right)}_{c_P}$

theory of energy conversion

Betz' theory:

maximum efficiency:

$$c_{P_{Betz}} = \frac{16}{27} \approx 0,59$$

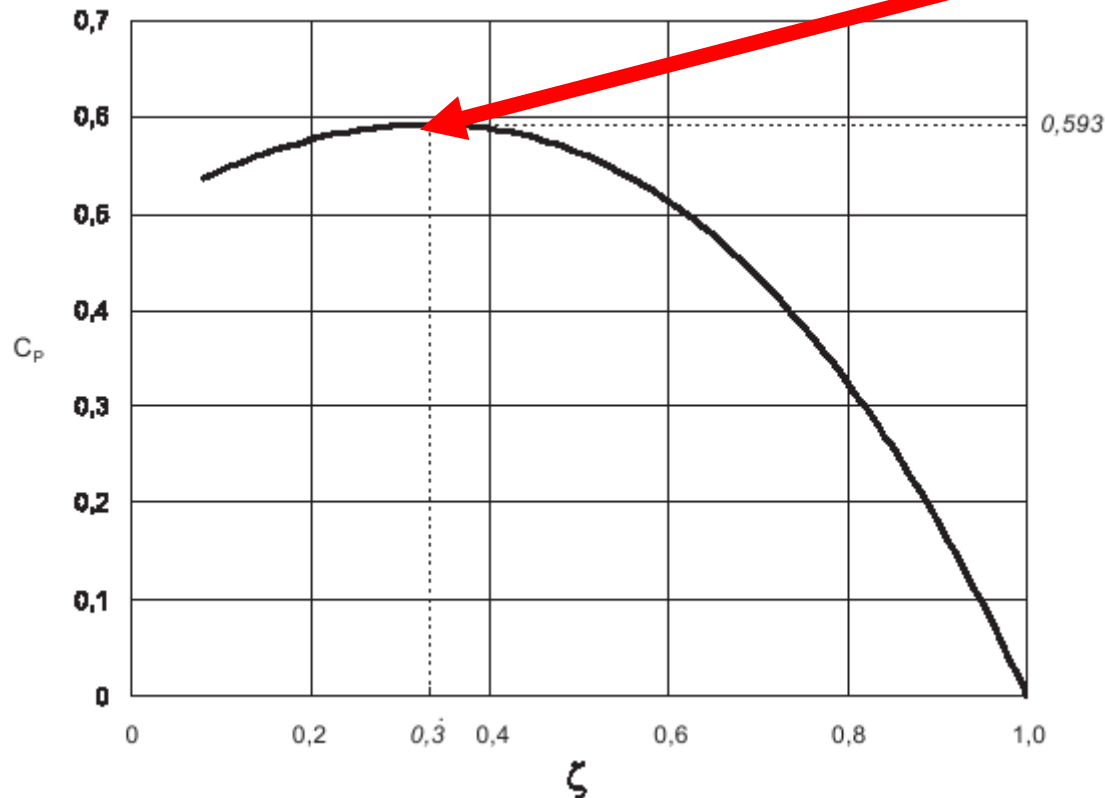

theory of energy conversion

airfoil theory:

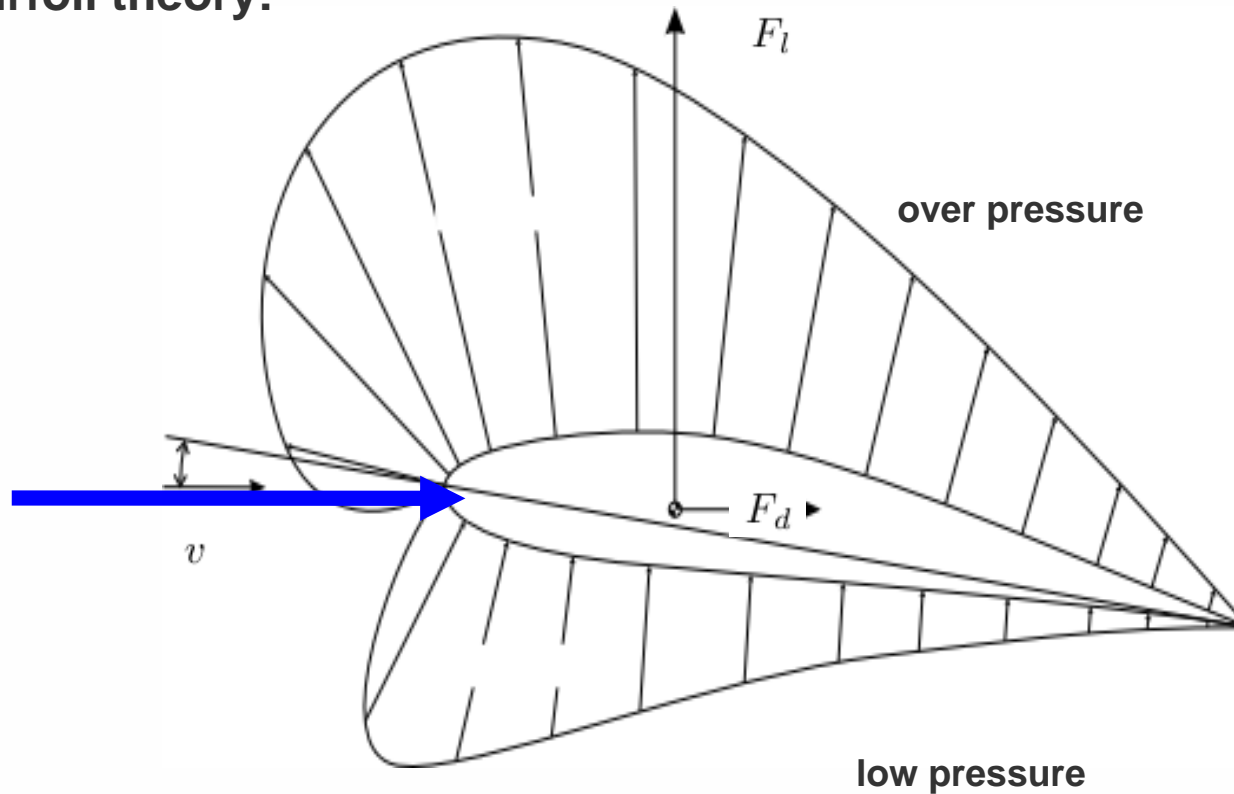

Investigations on current mills and wind turbines

- **Introduction**
- **Boundary Conditions**
 - wind vs. tidal currents
- **Theory of energy conversion**
 - Betz' theory
 - airfoil theory – lift and drag
- ***vertical axis free stream turbines***
 - vertical vs. horizontal axis
 - drag vs. lift based designs
 - lift based design: behaviour at low TSR
 - pitch-variable design – use of drag
 - numeric simulation for drag based design at low TSR

vertical axis free stream turbine

vertical vs. horizontal axis:

horizontal axis machines:

- significant losses due to angular momentum at low velocities



Schmitz' Theor

- sensitive to sea level change



rotation in 2 phases

- damages the blade

- severe decrease of power

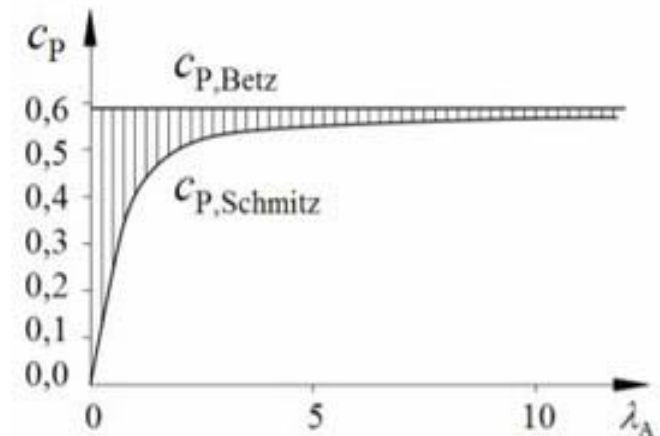

vertical axis free stream turbine

vertical vs. horizontal axis:

- vertical axis machines:
- not sensitive to sea level changes
 - Transmission and Generator can be built above sea level
 - efficient with low velocities

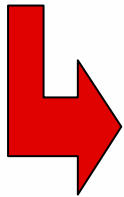

Investigation of vertical axis turbines for energy conversion from tidal currents!

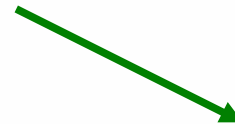

lift based designs

drag based designs

vertical axis free stream turbine

drag based turbines:

-oldest and simplest way to extract energy from the wind



persian wind turbine

anemometer



vertical axis free stream turbine

drag based turbines:

theory: - area A with moving with velocity u
 - wind speed v

Power: $P_T = F_W u$

Force: $F_W = \frac{\rho}{2} c_W A v_{rel}^2$

with $v_{rel} = v_{\infty} - u$

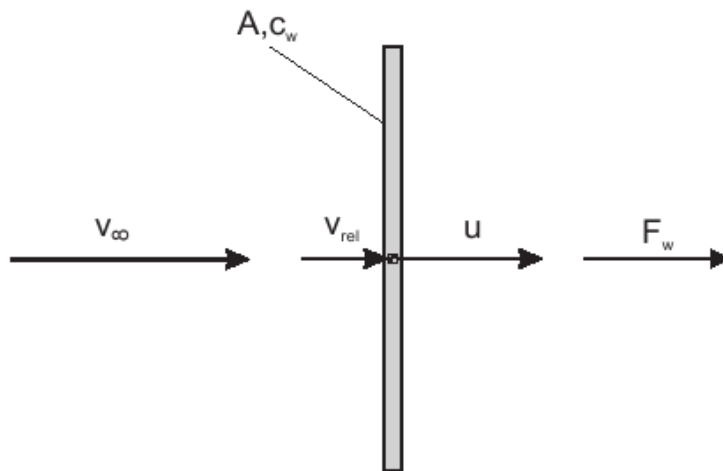

$$P_T = \frac{\rho}{2} c_W A (v_{\infty} - u)^2 u$$

vertical axis free stream turbine

drag based turbines:

power coefficient:
$$c_{P,W} = \frac{c_W (v_\infty - u)^2 u}{v_\infty^3} = c_W \left(1 - \frac{u}{v_\infty}\right)^2 \frac{u}{v_\infty}$$

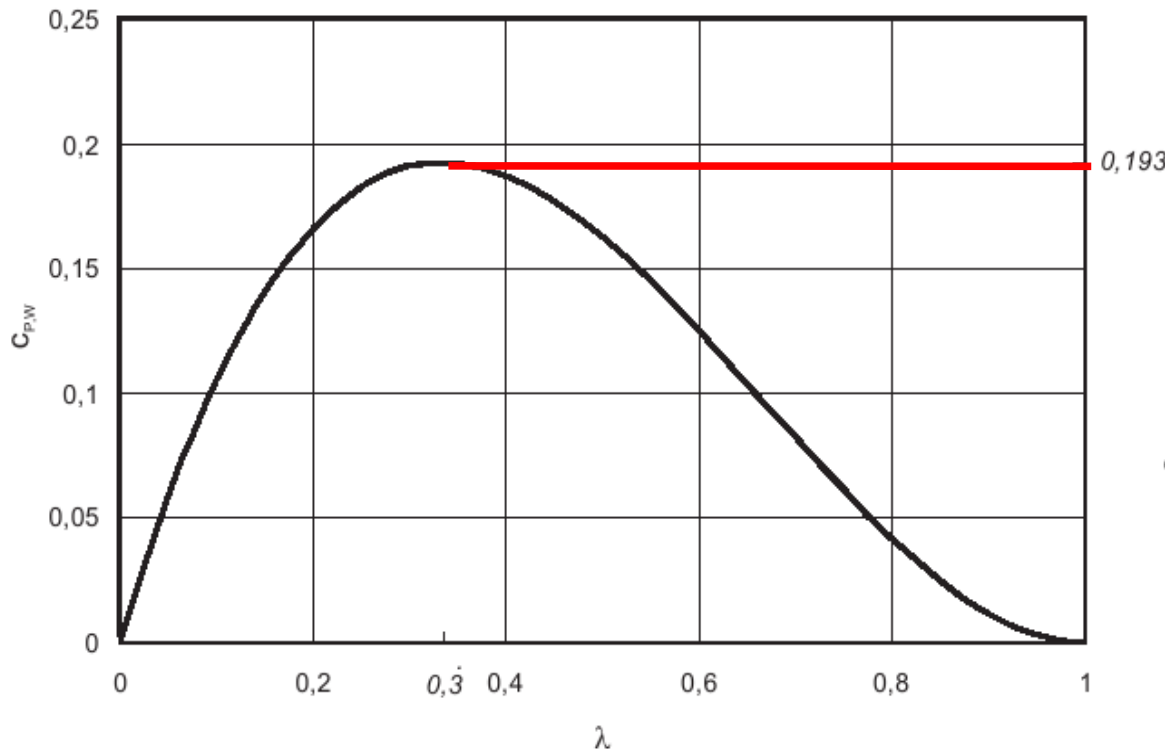

with
$$\lambda = \frac{u}{v_\infty} = \frac{r\omega}{v_\infty}$$

$$c_{P,w} = c_w \frac{A}{A_{Rotor}} (1 - \lambda)^2 \lambda$$

vertical axis free stream turbine

drag based turbines :

-drag forces on the way back

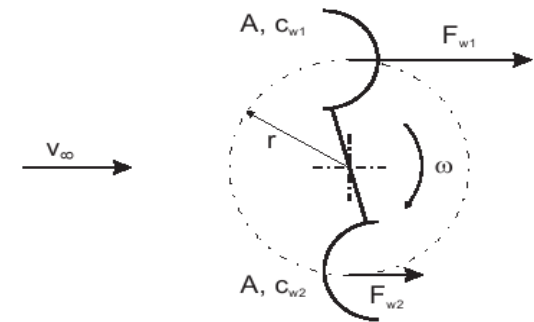

real power coefficient:

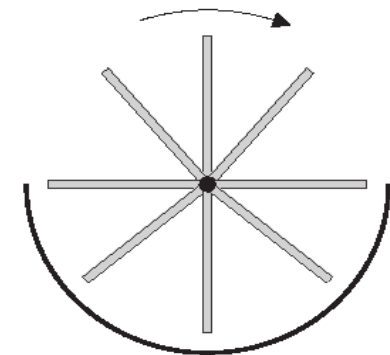
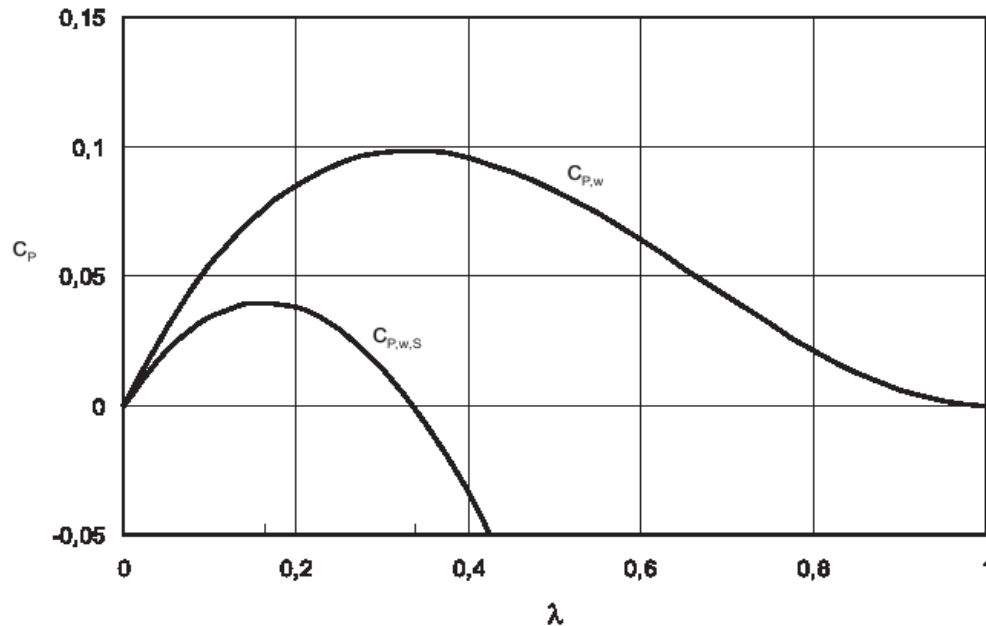

vertical axis free stream turbine

Lift based turbines:



Darrieus turbine

H-Darrieus turbine



How can we calculate the power of such a machine?

vertical axis free stream turbine

lift based design:

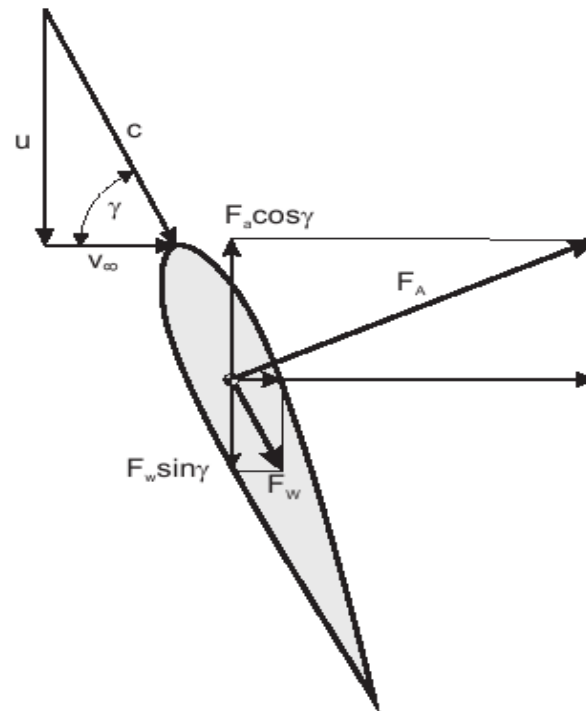

vertical axis free stream turbine

lift based design: theory:

velocity:

$$\tan \gamma = \frac{u}{v_\infty} = \lambda$$

power:

$$P = (F_A \cos \gamma - F_W \sin \gamma)u$$

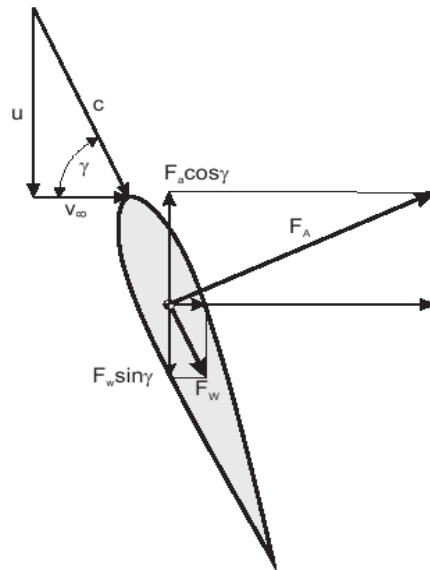

$$P = \frac{\rho}{2} A v_\infty^3 c_A \lambda \sqrt{1 + \lambda^2} \left(1 - \frac{\lambda c_W}{c_A} \right)$$

power coefficient:

$$c_{P,A} = c_A \lambda \sqrt{1 + \lambda^2} \left(1 - \frac{\lambda}{\frac{c_A}{c_W}} \right)$$

vertical axis free stream turbine

lift based design: theory:

$$c_{P,A} = c_A \lambda \sqrt{1 + \lambda^2} \left(1 - \frac{\lambda}{\frac{c_A}{c_W}}\right)$$

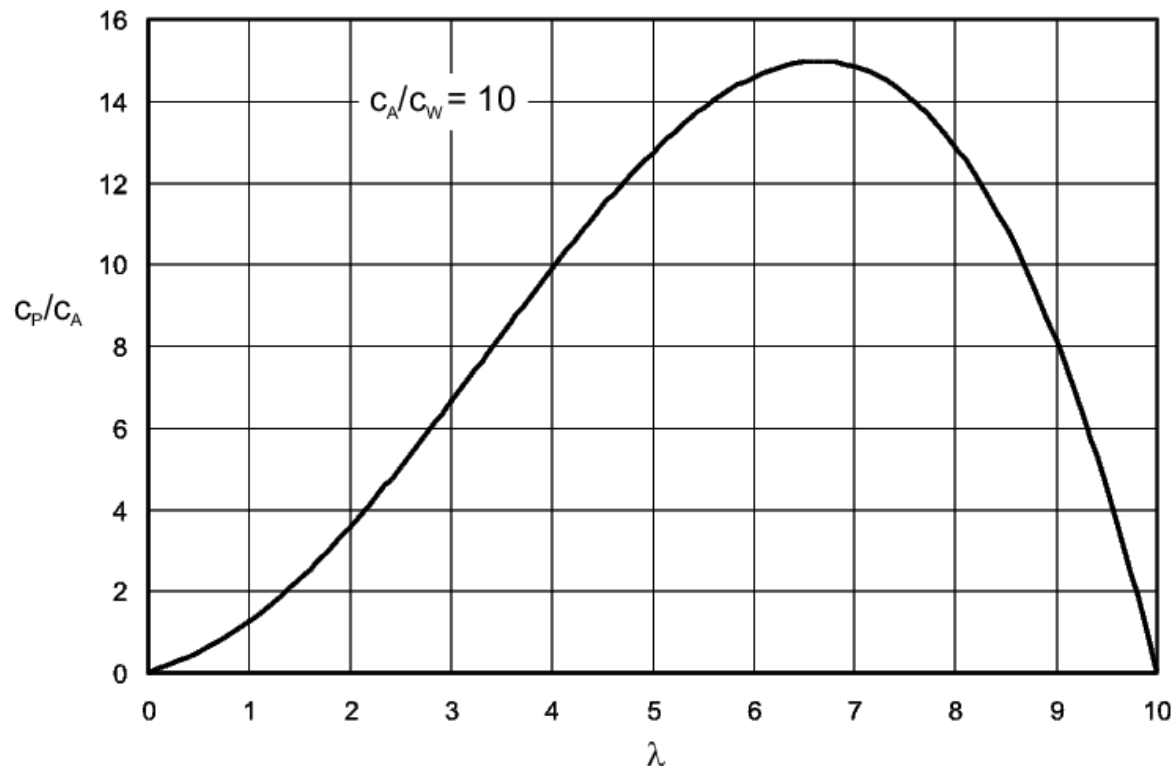

ide ratio :

$$\epsilon = \frac{c_A}{c_W}$$

vertical axis free stream turbine

lift based design: comparison to drag based design:

- ratio of the maximum power:

$$\frac{P_{max,A}}{P_{max,W}} \sim \left(\frac{c_A}{c_W}\right)^2$$

example: plate with glide ratio 10

use of lift is 100 times better than use of drag!

vertical axis free stream turbine

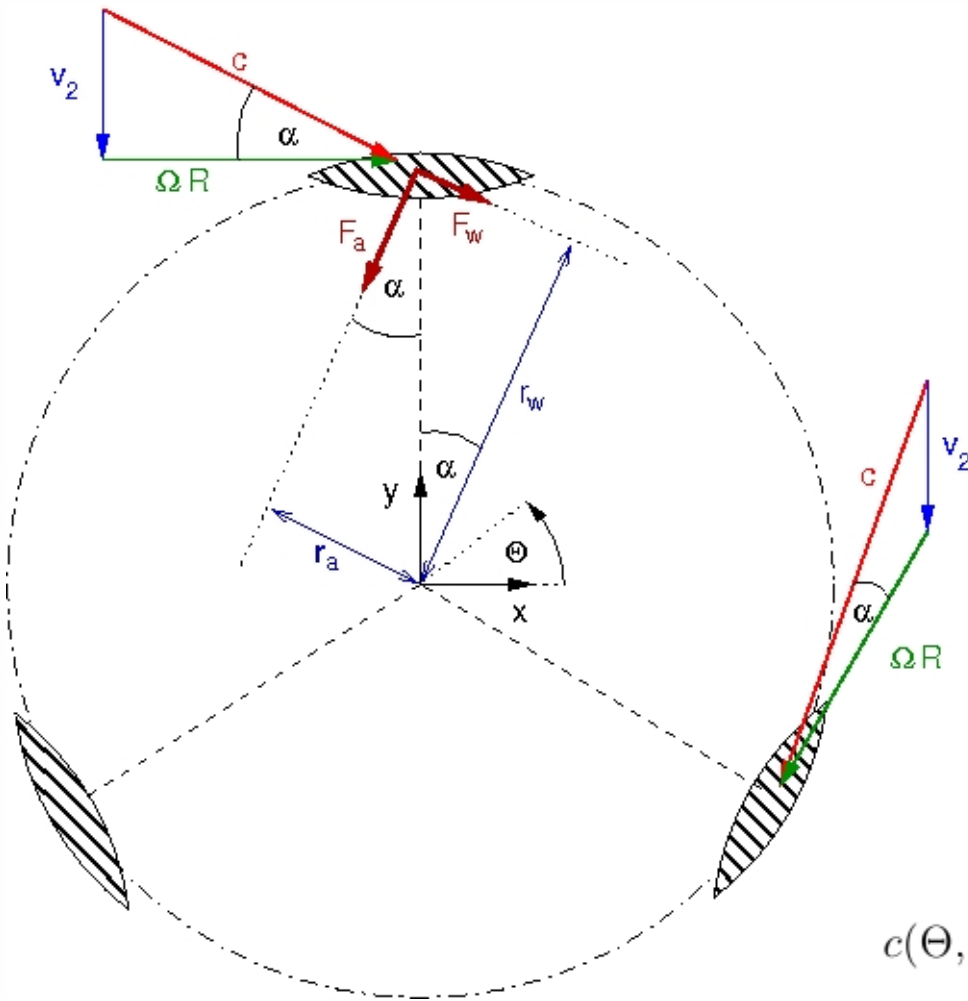

Lift based turbines:

main characteristics:

tip speed ratio:

$$\lambda = \frac{\Omega R}{v_1}$$

angle of attack:

$$\alpha(\Theta, \lambda) = \begin{cases} \arcsin\left(\frac{\cos\Theta}{\lambda}\right) & , \frac{\pi}{2} < \Theta < \frac{3\pi}{2} \\ -\arcsin\left(\frac{\cos\Theta}{\lambda}\right) & , \text{sonst} \end{cases}$$

relative velocity:

$$c(\Theta, \lambda) = \sqrt{(v_2 + \lambda \cdot v_2 \cdot \sin\Theta)^2 + (\lambda \cdot v_2 \cdot \cos\Theta)^2}$$

vertical axis free stream turbine

Lift based turbines:

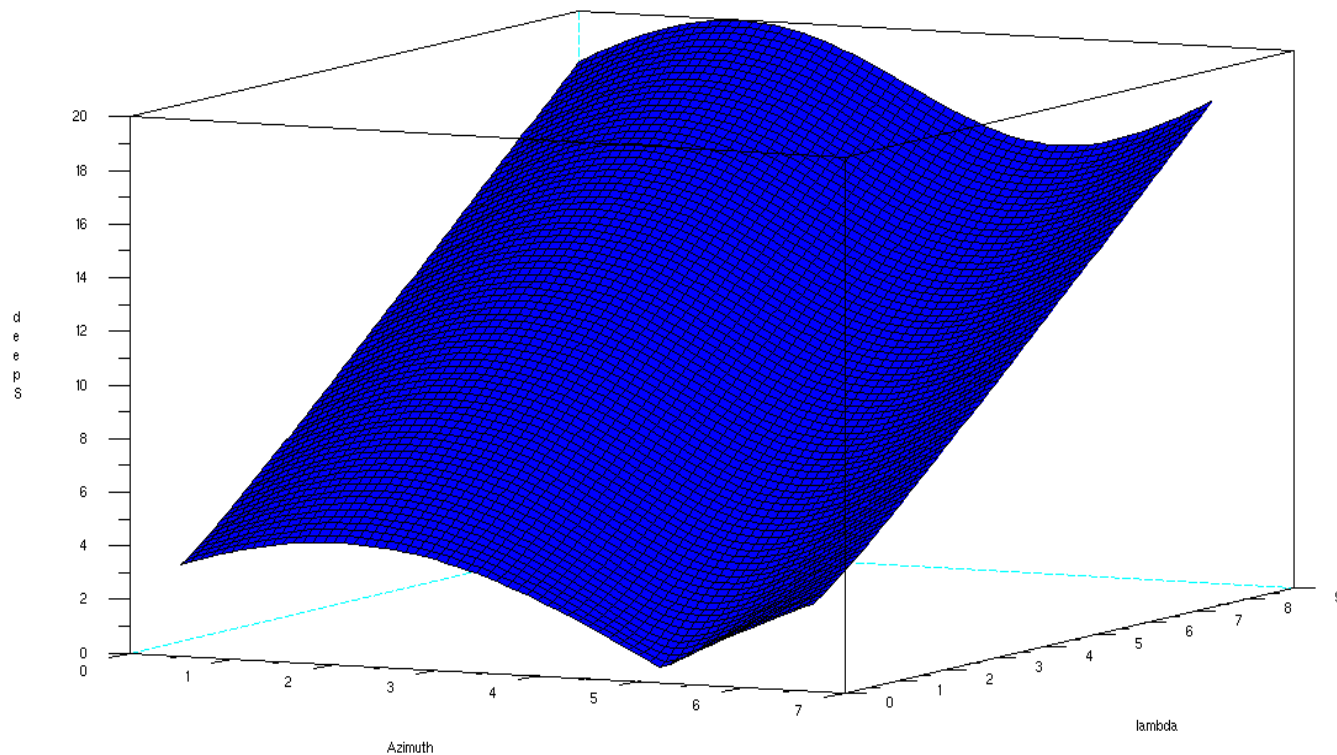

vertical axis free stream turbine

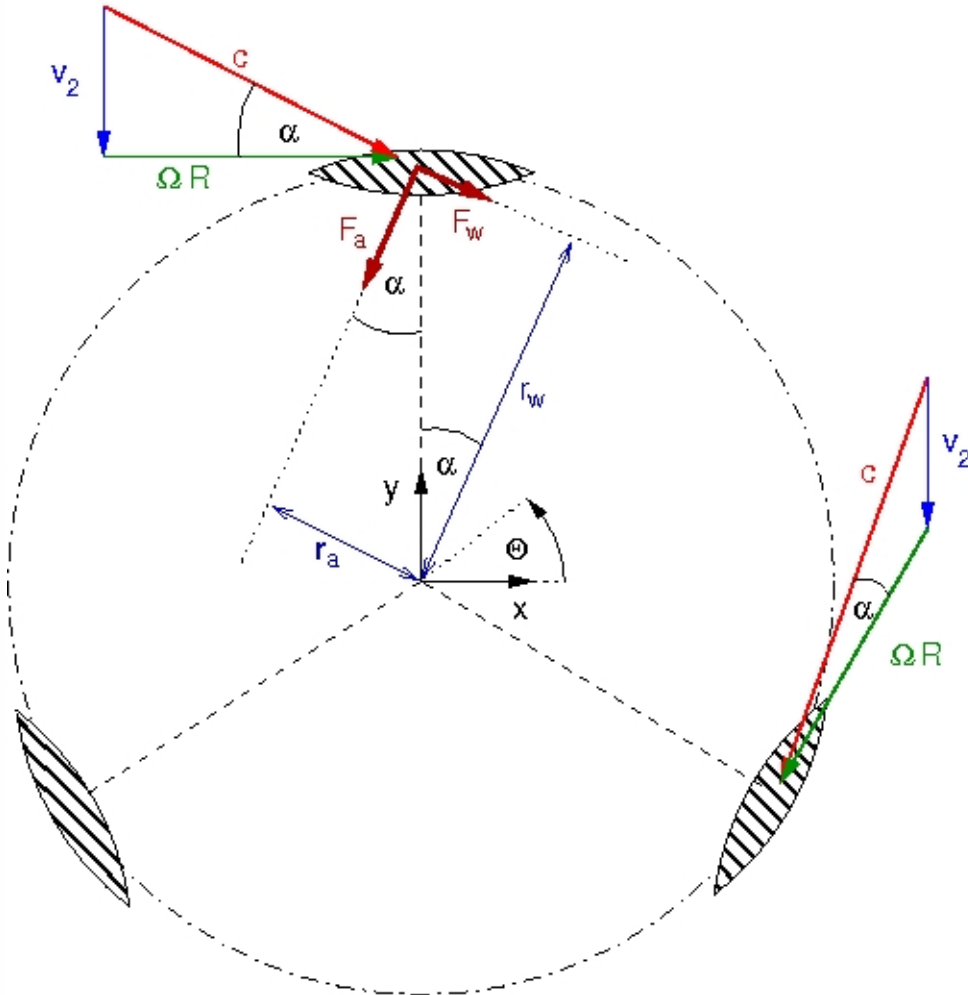

Lift based turbines:

Blade-Forces:

Lift:

$$F_a(\Theta, \lambda) = c_a(\Theta, \lambda) \cdot \frac{\rho}{2} \cdot c(\Theta, \lambda)^2 \cdot t_P \cdot H$$

?

Drag:

$$F_w(\Theta, \lambda) = c_w(\Theta, \lambda) \cdot \frac{\rho}{2} \cdot c(\Theta, \lambda)^2 \cdot t_P \cdot H$$

vertical axis free stream turbine

Lift based turbines:

Lift and drag coefficients:

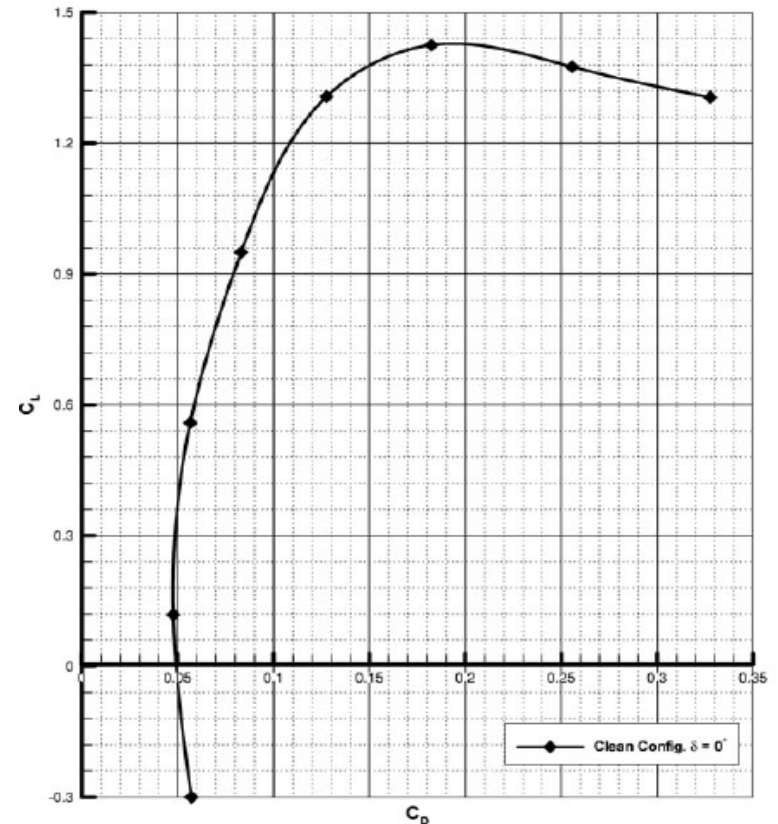
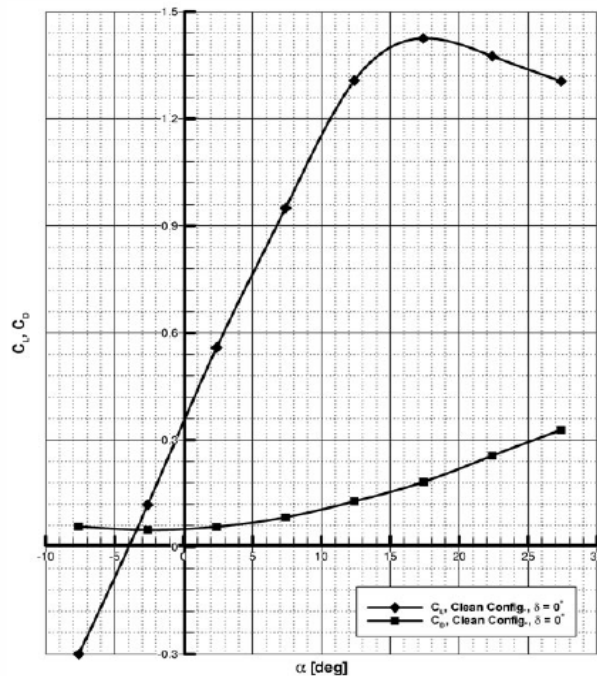

approximation:

$$c_a(\Theta, \lambda) = 2 \cdot \pi \cdot \sin(\alpha(\Theta, \lambda))$$

$$c_w(\Theta, \lambda) = \frac{c_a(\Theta, \lambda)}{100} + 0.04$$

vertical axis free stream turbine

Lift based turbines:

Our goal: - power calculation of the turbine:

$$P_{Rotor}(\lambda) = n M_{Rotor,ges}(\lambda) \Omega$$

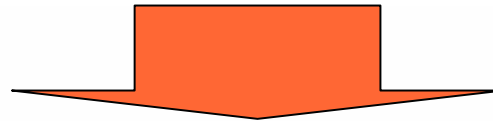

- torque produced by each blade:

$$M_{Rotor}(\Theta, \lambda) = F_a(\Theta, \lambda) r_a - F_w(\Theta, \lambda) r_w$$

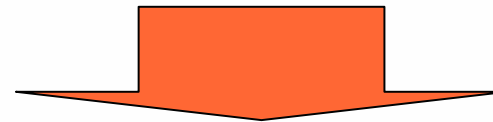

$$M_{Rotor,ges}(\lambda) = \int_0^{2\pi} M_{Rotor}(\Theta, \lambda) d\Theta$$

arms of the lever

$$r_a = R \sin(\alpha(\Theta, \lambda))$$

$$r_w = R \cos(\alpha(\Theta, \lambda))$$

vertical axis free stream turbine

lift based turbine:
obtain the power

$$P_{Rotor}(\lambda) = n M_{Rotor,ges}(\lambda) \Omega$$

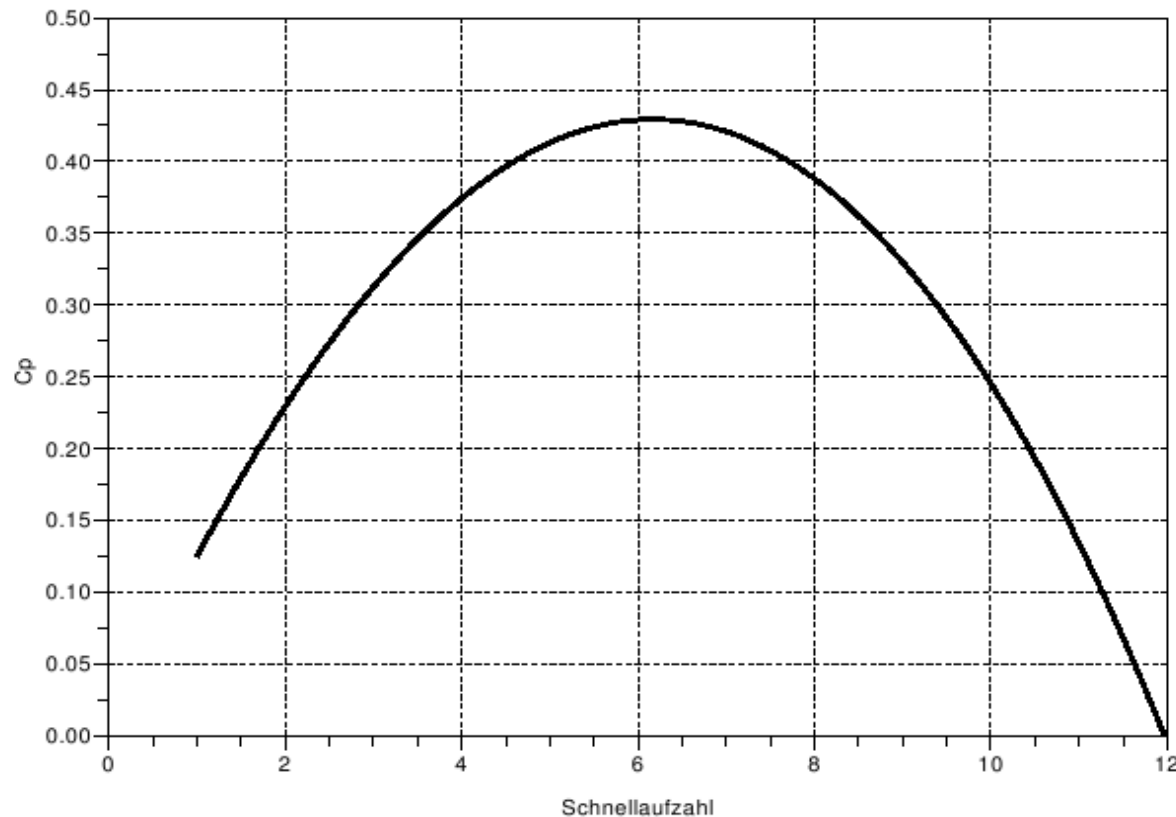

power coefficient:

$$c_p(\lambda) = \frac{P_{Rotor}}{\frac{\rho}{2} v_1^3 A_{Rotor}}$$

vertical axis free stream turbine

lift based design:

assumptions made:

- homogeneous stream through the turbine
- same velocity at all blades in every position
- angular momentum is to be neglected

validation of the method:

-influences of airfoil wake and angular momentum are essential

- no possible at low tip speed ratio!



this modell just for general lay out (order of magnitude)

vertical axis free stream turbine

lift based design: behaviour at low TSR:

high TSR:

low TSR

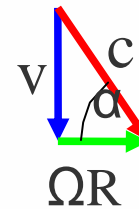
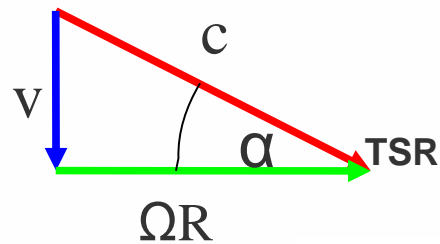

- angular of attack rises with decreasing

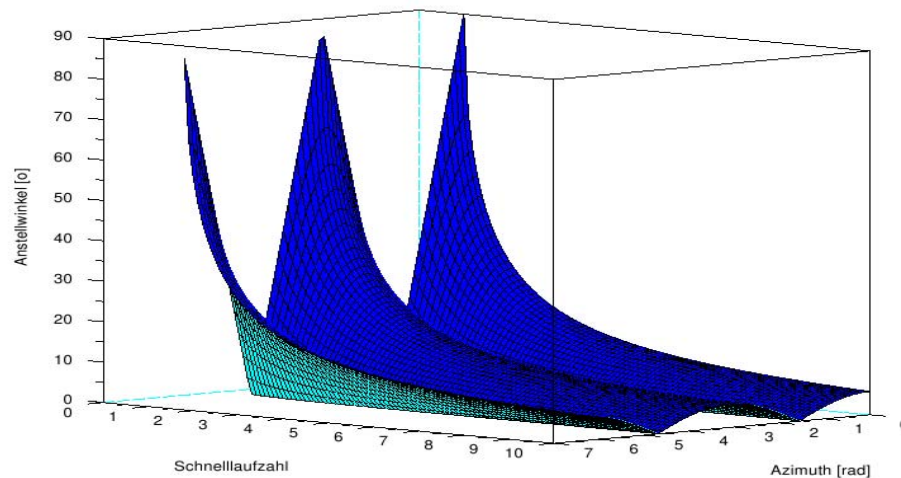

vertical axis free stream turbine

lift based design: behaviour at low TSR:

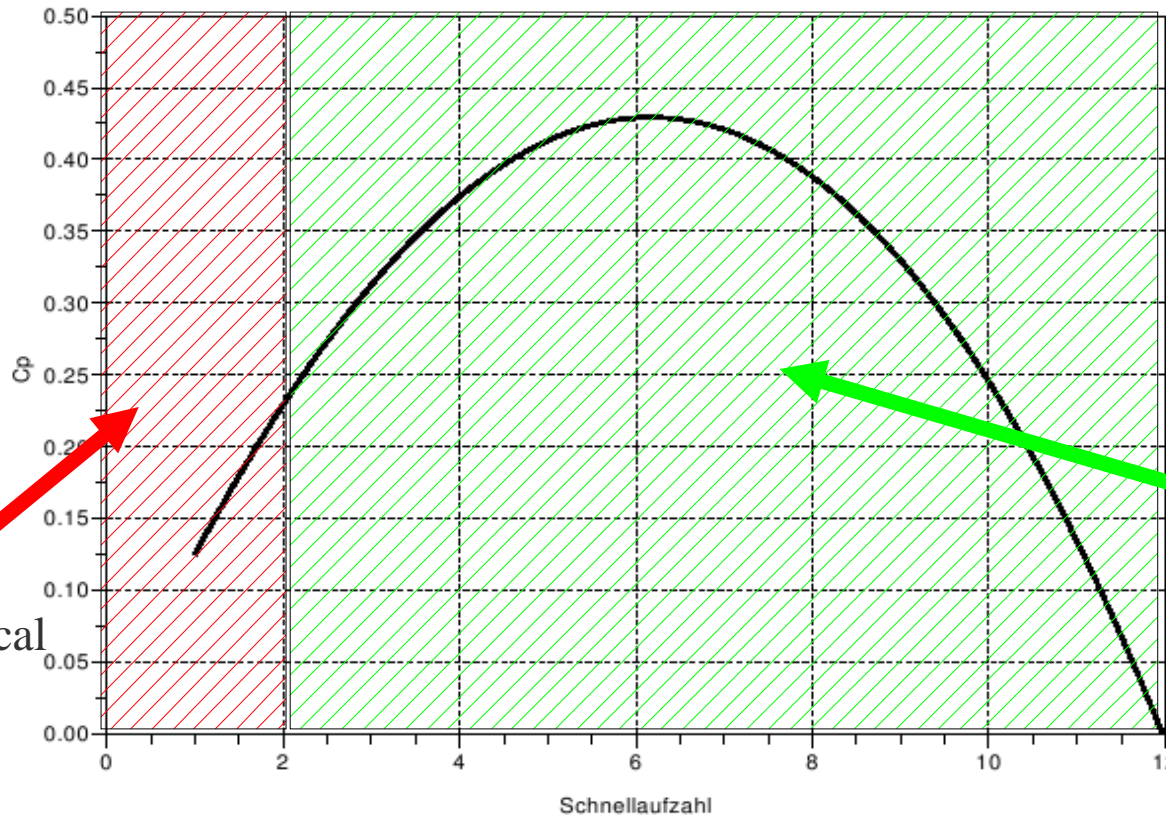

Power coefficient

$$c_p(\lambda) = \frac{P_{Rotor}}{\frac{\rho}{2} v_1^3 A_{Rotor}}$$

analytic model valid

numerical model needed

vertical axis free stream turbine

lift based design: behaviour at low TSR:

real power at low TSR:

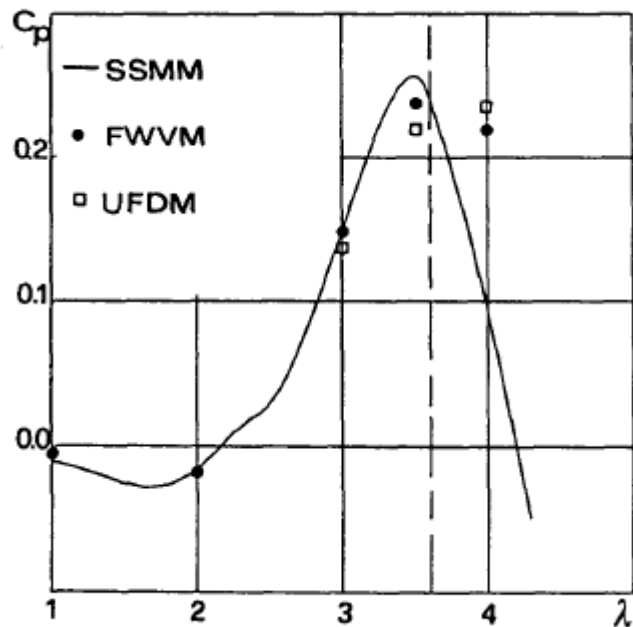

- negative power at low velocities due to stall effects
- no lift but still drag

- turbine will not be able to start by itself

- but: drag based systems have good starting

Idea: use pitch control to use airfoils as drag areas!

vertical axis free stream turbine

pitch-variable design – use of drag:
- two possible kinematics:

anticlockwise

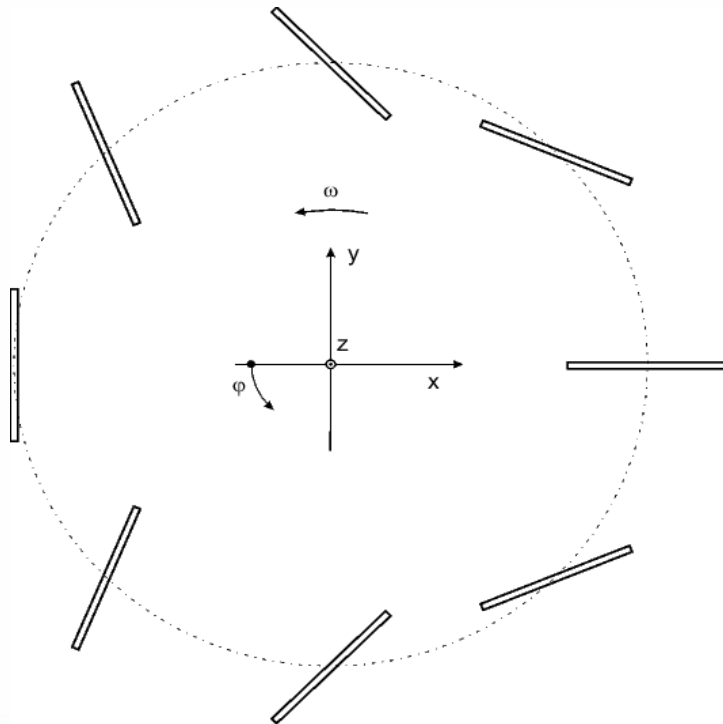

clockwise

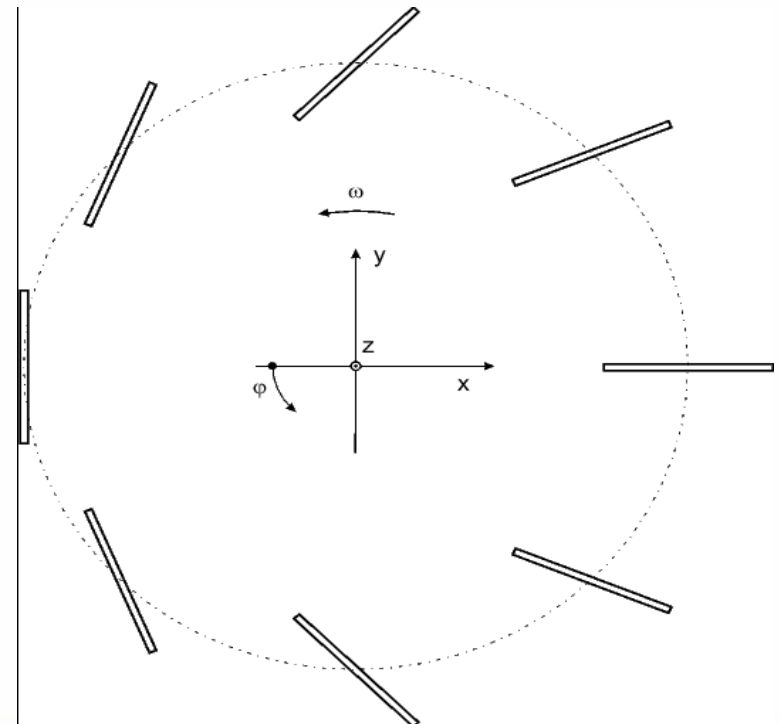

vertical axis free stream turbine

numeric simulation for drag based design at low TSR:

results:

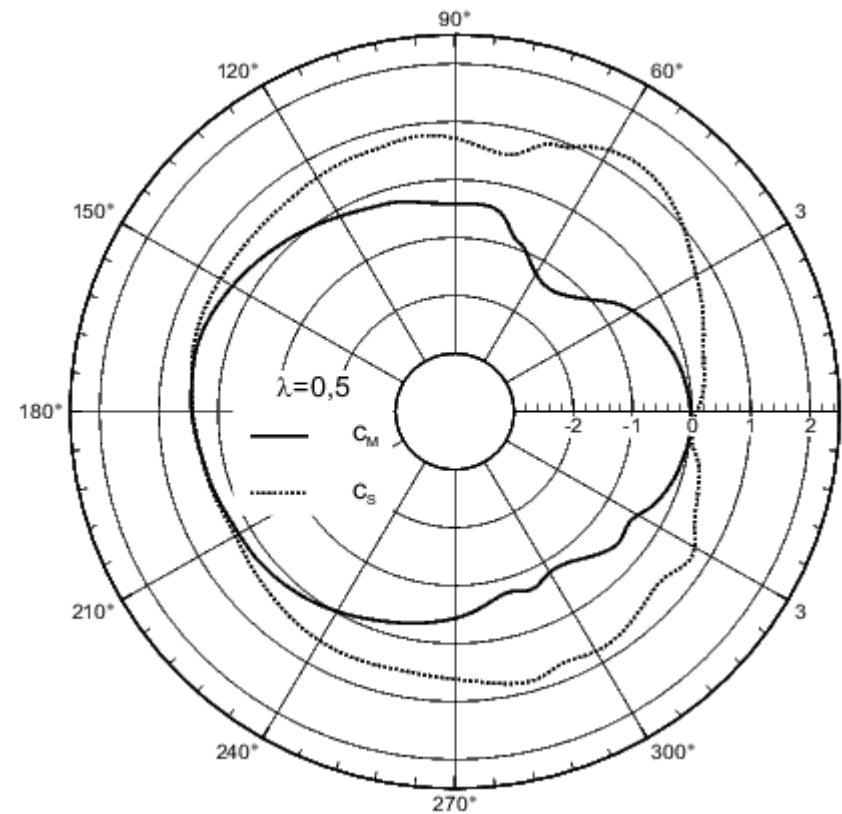
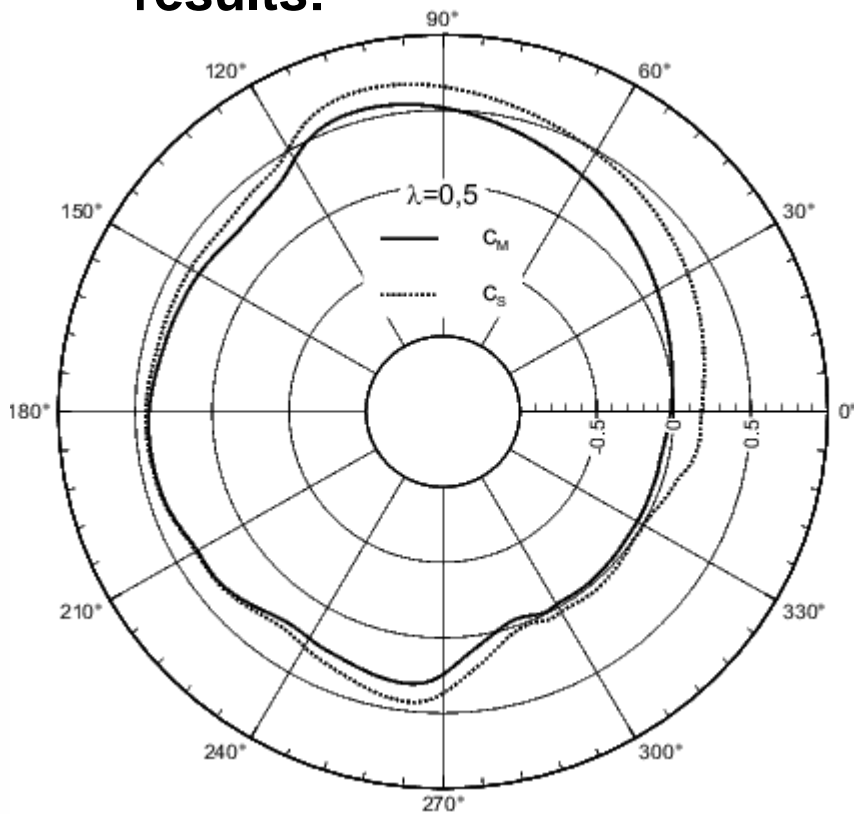

vertical axis free stream turbine

numeric simulation for drag based design at low TSR:

results: - videos

Investigations on current mills and wind turbines

Thank you very much!

Appendix: Incompressibility

pressure difference in front of the turbine and after it is negligible

$$\Delta p \approx 0$$

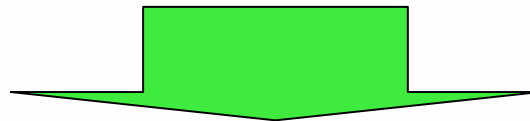

$$\Delta p \approx 0$$

incompressibility of the stream through the turbine

$$\delta \rho / \delta t = \delta \rho / \delta x_i = 0$$

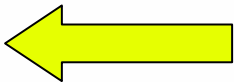

Appendix: Froude-Rankine-Theorem

Froude-Rankine-theorem :

conservation of momentum:

$$S = \dot{m}(v_1 - v_3)$$

Bernoulli 1 – 2

$$p_1 + \frac{\rho}{2}v_1^2 = p_{2-} + \frac{\rho}{2}v_2^2$$

Bernoulli 2 – 3

$$p_{2+} + \frac{\rho}{2}v_2^2 = p_3 + \frac{\rho}{2}v_3^2$$

pressure difference over the turbine:

$$p_{2-} - p_{2+} = \frac{\rho}{2}(v_1^2 - v_3^2)$$

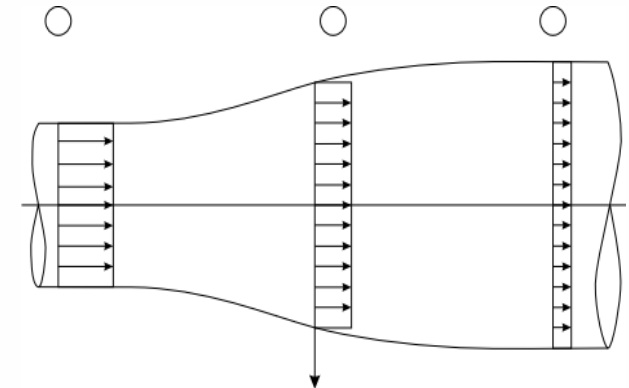

$$S = A(p_{2-} - p_{2+}) = A \left(\frac{\rho}{2}(v_1^2 - v_3^2) \right) = \dot{m}(v_1 - v_3) = \rho v_2 A_2 (v_1 - v_3)$$

$$v_2 = \frac{1}{2} \frac{(v_1 + v_3)(v_1 - v_3)}{(v_1 - v_3)} = \frac{v_1 + v_3}{2}$$

Appendix: Schmitz' theory

Schmitz' theory of losses due to the angular momentum:

$$C_{P_{Schmitz}} = \int_0^1 4\lambda \left(\frac{r}{R} \right)^2 \frac{\sin^3\left(\frac{2 \arctan\left(\frac{R}{\lambda r}\right)}{3}\right)}{\sin^2\left(\arctan\left(\frac{R}{\lambda r}\right)\right)} d\left(\frac{r}{R}\right)$$

