

Part III

PRAM Algorithms

Prefix Sum

input: $x[1] \dots x[n]$

output: $s[1] \dots s[n]$ with $s[i] = \sum_{j=1}^i x[j]$ (w.r.t. operator $*$)

Algorithm 6 PrefixSum($n, x[1] \dots x[n]$)

```
1: // compute prefixsums;  $n = 2^k$ 
2: if  $n = 1$  then  $s[1] \leftarrow x[1]$ ; return
3: for  $1 \leq i \leq n/2$  pardo
4:      $a[i] \leftarrow x[2i-1] * x[2i]$ 
5:  $z[1], \dots, z[n/2] \leftarrow \text{PrefixSum}(n/2, a[1] \dots a[n/2])$ 
6: for  $1 \leq i \leq n$  pardo
7:      $i$  even :  $s[i] \leftarrow z[i/2]$ 
8:      $i = 1$   :  $s[1] = x[1]$ 
9:      $i$  odd  :  $s[i] \leftarrow z[(i-1)/2] * x[i]$ 
```

Prefix Sum

input: $x[1] \dots x[n]$

output: $s[1] \dots s[n]$ with $s[i] = \sum_{j=1}^i x[j]$ (w.r.t. operator $*$)

Algorithm 6 PrefixSum($n, x[1] \dots x[n]$)

```
1: // compute prefixsums;  $n = 2^k$ 
2: if  $n = 1$  then  $s[1] \leftarrow x[1]$ ; return
3: for  $1 \leq i \leq n/2$  pardo
4:      $a[i] \leftarrow x[2i - 1] * x[2i]$ 
5:  $z[1], \dots, z[n/2] \leftarrow \text{PrefixSum}(n/2, a[1] \dots a[n/2])$ 
6: for  $1 \leq i \leq n$  pardo
7:      $i$  even :  $s[i] \leftarrow z[i/2]$ 
8:      $i = 1$   :  $s[1] = x[1]$ 
9:      $i$  odd  :  $s[i] \leftarrow z[(i - 1)/2] * x[i]$ 
```

Prefix Sum

s -values

time steps

x -values

Prefix Sum

s-values

time steps

- 1
- 2
- 3
- 4
- 5
- 6
- 7
- 8
- 9
- 10
- 11
- 12
- 13
- 14
- 15
- 16

x-values

Prefix Sum

s -values

time steps

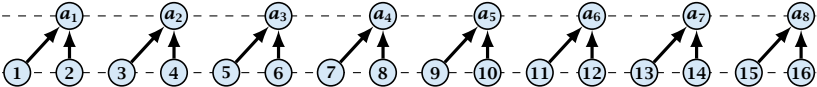

x -values

Prefix Sum

s-values

time steps

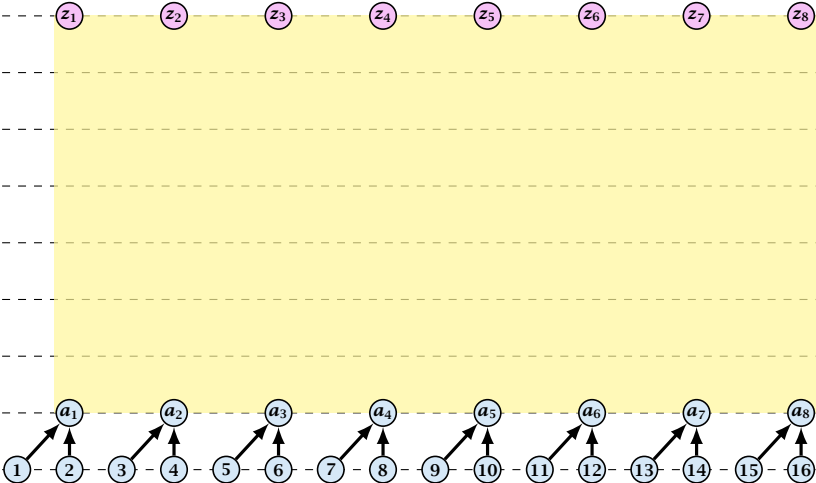

x-values

Prefix Sum

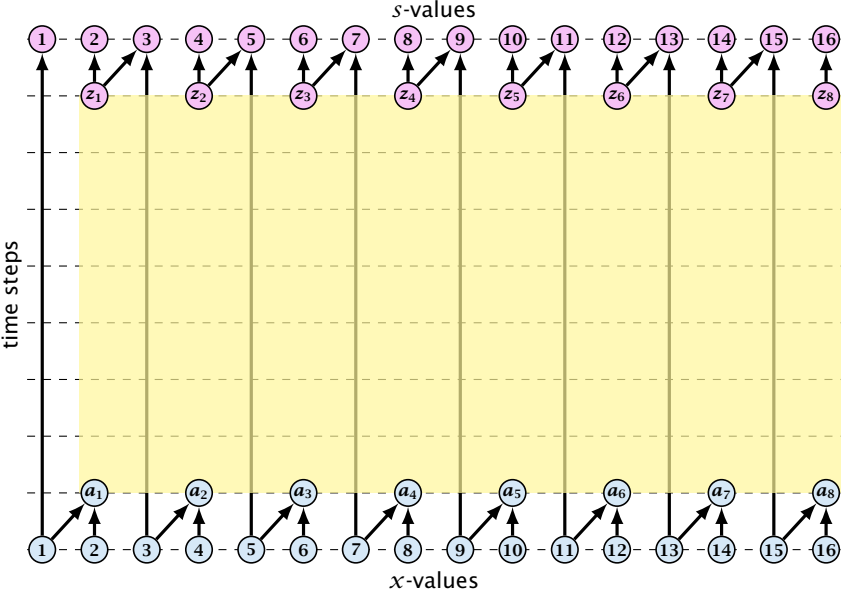

Prefix Sum

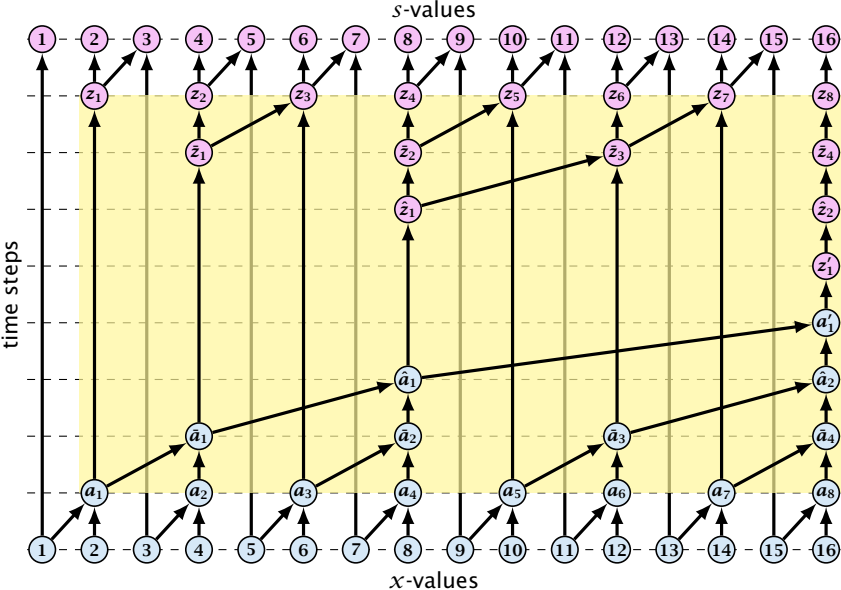

Prefix Sum

The algorithm uses work $\mathcal{O}(n)$ and time $\mathcal{O}(\log n)$ for solving Prefix Sum on an EREW-PRAM with n processors.

It is clearly work-optimal.

Theorem 1

On a CREW PRAM a Prefix Sum requires running time $\Omega(\log n)$ regardless of the number of processors.

Prefix Sum

The algorithm uses work $\mathcal{O}(n)$ and time $\mathcal{O}(\log n)$ for solving Prefix Sum on an EREW-PRAM with n processors.

It is clearly work-optimal.

Theorem 1

On a CREW PRAM a Prefix Sum requires running time $\Omega(\log n)$ regardless of the number of processors.

Prefix Sum

The algorithm uses work $\mathcal{O}(n)$ and time $\mathcal{O}(\log n)$ for solving Prefix Sum on an EREW-PRAM with n processors.

It is clearly work-optimal.

Theorem 1

On a CREW PRAM a Prefix Sum requires running time $\Omega(\log n)$ regardless of the number of processors.

Parallel Prefix

Input: a linked list given by successor pointers; a value $x[i]$ for every list element; an operator $*$;

Output: for every list position ℓ the sum (w.r.t. $*$) of elements after ℓ in the list (including ℓ)

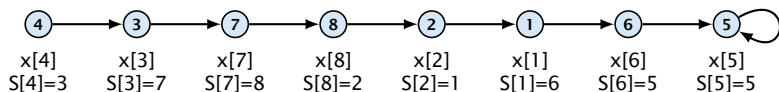

Parallel Prefix

Algorithm 7 ParallelPrefix

```
1: for  $1 \leq i \leq n$  pardo
2:    $P[i] \leftarrow S[i]$ 
3:   while  $S[i] \neq S[S[i]]$  do
4:      $x[i] \leftarrow x[i] * x[S[i]]$ 
5:      $S[i] \leftarrow S[S[i]]$ 
6:   if  $P[i] \neq i$  then  $x[i] \leftarrow x[i] * x[S(i)]$ 
```

The algorithm runs in time $\mathcal{O}(\log n)$.

It has work requirement $\mathcal{O}(n \log n)$. non-optimal

This technique is also known as pointer jumping

Parallel Prefix

Algorithm 7 ParallelPrefix

```
1: for  $1 \leq i \leq n$  pardo
2:    $P[i] \leftarrow S[i]$ 
3:   while  $S[i] \neq S[S[i]]$  do
4:      $x[i] \leftarrow x[i] * x[S[i]]$ 
5:      $S[i] \leftarrow S[S[i]]$ 
6:   if  $P[i] \neq i$  then  $x[i] \leftarrow x[i] * x[S(i)]$ 
```

The algorithm runs in time $\mathcal{O}(\log n)$.

It has work requirement $\mathcal{O}(n \log n)$. non-optimal

This technique is also known as pointer jumping

Parallel Prefix

Algorithm 7 ParallelPrefix

```
1: for  $1 \leq i \leq n$  pardo
2:    $P[i] \leftarrow S[i]$ 
3:   while  $S[i] \neq S[S[i]]$  do
4:      $x[i] \leftarrow x[i] * x[S[i]]$ 
5:      $S[i] \leftarrow S[S[i]]$ 
6:   if  $P[i] \neq i$  then  $x[i] \leftarrow x[i] * x[S(i)]$ 
```

The algorithm runs in time $\mathcal{O}(\log n)$.

It has work requirement $\mathcal{O}(n \log n)$. **non-optimal**

This technique is also known as **pointer jumping**

Parallel Prefix

Algorithm 7 ParallelPrefix

```
1: for  $1 \leq i \leq n$  pardo
2:    $P[i] \leftarrow S[i]$ 
3:   while  $S[i] \neq S[S[i]]$  do
4:      $x[i] \leftarrow x[i] * x[S[i]]$ 
5:      $S[i] \leftarrow S[S[i]]$ 
6:   if  $P[i] \neq i$  then  $x[i] \leftarrow x[i] * x[S(i)]$ 
```

The algorithm runs in time $\mathcal{O}(\log n)$.

It has work requirement $\mathcal{O}(n \log n)$. **non-optimal**

This technique is also known as **pointer jumping**

4.3 Divide & Conquer — Merging

Given two sorted sequences $A = (a_1, \dots, a_n)$ and $B = (b_1, \dots, b_n)$, compute the sorted sequence $C = (c_1, \dots, c_n)$.

Definition 2

Let $X = (x_1, \dots, x_t)$ be a sequence. The **rank** $\text{rank}(y : X)$ of y in X is

$$\text{rank}(y : X) = |\{x \in X \mid x \leq y\}|$$

For a sequence $Y = (y_1, \dots, y_s)$ we define $\text{rank}(Y : X) := (r_1, \dots, r_s)$ with $r_i = \text{rank}(y_i : X)$.

4.3 Divide & Conquer — Merging

Given two sorted sequences $A = (a_1, \dots, a_n)$ and $B = (b_1, \dots, b_n)$, compute the sorted sequence $C = (c_1, \dots, c_n)$.

Definition 2

Let $X = (x_1, \dots, x_t)$ be a sequence. The **rank** $\text{rank}(y : X)$ of y in X is

$$\text{rank}(y : X) = |\{x \in X \mid x \leq y\}|$$

For a sequence $Y = (y_1, \dots, y_s)$ we define $\text{rank}(Y : X) := (r_1, \dots, r_s)$ with $r_i = \text{rank}(y_i : X)$.

4.3 Divide & Conquer — Merging

Given two sorted sequences $A = (a_1, \dots, a_n)$ and $B = (b_1, \dots, b_n)$, compute the sorted sequence $C = (c_1, \dots, c_n)$.

Definition 2

Let $X = (x_1, \dots, x_t)$ be a sequence. The **rank** $\text{rank}(y : X)$ of y in X is

$$\text{rank}(y : X) = |\{x \in X \mid x \leq y\}|$$

For a sequence $Y = (y_1, \dots, y_s)$ we define $\text{rank}(Y : X) := (r_1, \dots, r_s)$ with $r_i = \text{rank}(y_i : X)$.

4.3 Divide & Conquer — Merging

Given two sorted sequences $A = (a_1, \dots, a_n)$ and $B = (b_1, \dots, b_n)$, compute the sorted sequence $C = (c_1, \dots, c_n)$.

Definition 2

Let $X = (x_1, \dots, x_t)$ be a sequence. The **rank** $\text{rank}(y : X)$ of y in X is

$$\text{rank}(y : X) = |\{x \in X \mid x \leq y\}|$$

For a sequence $Y = (y_1, \dots, y_s)$ we define $\text{rank}(Y : X) := (r_1, \dots, r_s)$ with $r_i = \text{rank}(y_i : X)$.

4.3 Divide & Conquer — Merging

Given two sorted sequences $A = (a_1 \dots a_n)$ and $B = (b_1 \dots b_n)$, compute the sorted sequence $C = (c_1 \dots c_n)$.

Observation:

We can assume wlog. that elements in A and B are different.

Then for $c_i \in C$ we have $i = \text{rank}(c_i : A \cup B)$.

This means we just need to determine $\text{rank}(x : A \cup B)$ for all elements!

Observe, that $\text{rank}(x : A \cup B) = \text{rank}(x : A) + \text{rank}(x : B)$.

Clearly, for $x \in A$ we already know $\text{rank}(x : A)$, and for $x \in B$ we know $\text{rank}(x : B)$.

4.3 Divide & Conquer — Merging

Given two sorted sequences $A = (a_1 \dots a_n)$ and $B = (b_1 \dots b_n)$, compute the sorted sequence $C = (c_1 \dots c_n)$.

Observation:

We can assume wlog. that elements in A and B are different.

Then for $c_i \in C$ we have $i = \text{rank}(c_i : A \cup B)$.

This means we just need to determine $\text{rank}(x : A \cup B)$ for all elements!

Observe, that $\text{rank}(x : A \cup B) = \text{rank}(x : A) + \text{rank}(x : B)$.

Clearly, for $x \in A$ we already know $\text{rank}(x : A)$, and for $x \in B$ we know $\text{rank}(x : B)$.

4.3 Divide & Conquer — Merging

Given two sorted sequences $A = (a_1 \dots a_n)$ and $B = (b_1 \dots b_n)$, compute the sorted sequence $C = (c_1 \dots c_n)$.

Observation:

We can assume wlog. that elements in A and B are different.

Then for $c_i \in C$ we have $i = \text{rank}(c_i : A \cup B)$.

This means we just need to determine $\text{rank}(x : A \cup B)$ for all elements!

Observe, that $\text{rank}(x : A \cup B) = \text{rank}(x : A) + \text{rank}(x : B)$.

Clearly, for $x \in A$ we already know $\text{rank}(x : A)$, and for $x \in B$ we know $\text{rank}(x : B)$.

4.3 Divide & Conquer — Merging

Given two sorted sequences $A = (a_1 \dots a_n)$ and $B = (b_1 \dots b_n)$, compute the sorted sequence $C = (c_1 \dots c_n)$.

Observation:

We can assume wlog. that elements in A and B are different.

Then for $c_i \in C$ we have $i = \text{rank}(c_i : A \cup B)$.

This means we just need to determine $\text{rank}(x : A \cup B)$ for all elements!

Observe, that $\text{rank}(x : A \cup B) = \text{rank}(x : A) + \text{rank}(x : B)$.

Clearly, for $x \in A$ we already know $\text{rank}(x : A)$, and for $x \in B$ we know $\text{rank}(x : B)$.

4.3 Divide & Conquer — Merging

Given two sorted sequences $A = (a_1 \dots a_n)$ and $B = (b_1 \dots b_n)$, compute the sorted sequence $C = (c_1 \dots c_n)$.

Observation:

We can assume wlog. that elements in A and B are different.

Then for $c_i \in C$ we have $i = \text{rank}(c_i : A \cup B)$.

This means we just need to determine $\text{rank}(x : A \cup B)$ for all elements!

Observe, that $\text{rank}(x : A \cup B) = \text{rank}(x : A) + \text{rank}(x : B)$.

Clearly, for $x \in A$ we already know $\text{rank}(x : A)$, and for $x \in B$ we know $\text{rank}(x : B)$.

4.3 Divide & Conquer — Merging

Given two sorted sequences $A = (a_1 \dots a_n)$ and $B = (b_1 \dots b_n)$, compute the sorted sequence $C = (c_1 \dots c_n)$.

Observation:

We can assume wlog. that elements in A and B are different.

Then for $c_i \in C$ we have $i = \text{rank}(c_i : A \cup B)$.

This means we just need to determine $\text{rank}(x : A \cup B)$ for all elements!

Observe, that $\text{rank}(x : A \cup B) = \text{rank}(x : A) + \text{rank}(x : B)$.

Clearly, for $x \in A$ we already know $\text{rank}(x : A)$, and for $x \in B$ we know $\text{rank}(x : B)$.

4.3 Divide & Conquer — Merging

Given two sorted sequences $A = (a_1 \dots a_n)$ and $B = (b_1 \dots b_n)$, compute the sorted sequence $C = (c_1 \dots c_n)$.

Observation:

We can assume wlog. that elements in A and B are different.

Then for $c_i \in C$ we have $i = \text{rank}(c_i : A \cup B)$.

This means we just need to determine $\text{rank}(x : A \cup B)$ for all elements!

Observe, that $\text{rank}(x : A \cup B) = \text{rank}(x : A) + \text{rank}(x : B)$.

Clearly, for $x \in A$ we already know $\text{rank}(x : A)$, and for $x \in B$ we know $\text{rank}(x : B)$.

4.3 Divide & Conquer — Merging

Compute $\text{rank}(x : A)$ for all $x \in B$ and $\text{rank}(x : B)$ for all $x \in A$.
can be done in $\mathcal{O}(\log n)$ time with $2n$ processors by binary search

Lemma 3

On a CREW PRAM, Merging can be done in $\mathcal{O}(\log n)$ time and $\mathcal{O}(n \log n)$ work.

not optimal

4.3 Divide & Conquer — Merging

Compute $\text{rank}(x : A)$ for all $x \in B$ and $\text{rank}(x : B)$ for all $x \in A$.
can be done in $\mathcal{O}(\log n)$ time with $2n$ processors by binary search

Lemma 3

On a CREW PRAM, Merging can be done in $\mathcal{O}(\log n)$ time and $\mathcal{O}(n \log n)$ work.

not optimal

4.3 Divide & Conquer — Merging

Compute $\text{rank}(x : A)$ for all $x \in B$ and $\text{rank}(x : B)$ for all $x \in A$.
can be done in $\mathcal{O}(\log n)$ time with $2n$ processors by binary search

Lemma 3

On a CREW PRAM, Merging can be done in $\mathcal{O}(\log n)$ time and $\mathcal{O}(n \log n)$ work.

not optimal

4.3 Divide & Conquer — Merging

Compute $\text{rank}(x : A)$ for all $x \in B$ and $\text{rank}(x : B)$ for all $x \in A$.
can be done in $\mathcal{O}(\log n)$ time with $2n$ processors by binary search

Lemma 3

On a CREW PRAM, Merging can be done in $\mathcal{O}(\log n)$ time and $\mathcal{O}(n \log n)$ work.

not optimal

4.3 Divide & Conquer — Merging

$A = (a_1, \dots, a_n); B = (b_1, \dots, b_n);$
log n integral; $k := n / \log n$ integral;

Algorithm 8 GenerateSubproblems

```
1:  $j_0 \leftarrow 0$ 
2:  $j_k \leftarrow n$ 
3: for  $1 \leq i \leq k - 1$  pardo
4:    $j_i \leftarrow \text{rank}(b_{i \log n} : A)$ 
5: for  $0 \leq i \leq k - 1$  pardo
6:    $B_i \leftarrow (b_{i \log n + 1}, \dots, b_{(i+1) \log n})$ 
7:    $A_i \leftarrow (a_{j_i + 1}, \dots, a_{j_{i+1}})$ 
```

If C_i is the merging of A_i and B_i then the sequence $C_0 \dots C_{k-1}$ is a sorted sequence.

4.3 Divide & Conquer — Merging

$A = (a_1, \dots, a_n); B = (b_1, \dots, b_n);$
log n integral; $k := n / \log n$ integral;

Algorithm 8 GenerateSubproblems

```
1:  $j_0 \leftarrow 0$ 
2:  $j_k \leftarrow n$ 
3: for  $1 \leq i \leq k - 1$  pardo
4:    $j_i \leftarrow \text{rank}(b_{i \log n} : A)$ 
5: for  $0 \leq i \leq k - 1$  pardo
6:    $B_i \leftarrow (b_{i \log n + 1}, \dots, b_{(i+1) \log n})$ 
7:    $A_i \leftarrow (a_{j_i + 1}, \dots, a_{j_{i+1}})$ 
```

If C_i is the merging of A_i and B_i then the sequence $C_0 \dots C_{k-1}$ is a sorted sequence.

4.3 Divide & Conquer — Merging

$A = (a_1, \dots, a_n); B = (b_1, \dots, b_n);$
log n integral; $k := n / \log n$ integral;

Algorithm 8 GenerateSubproblems

```
1:  $j_0 \leftarrow 0$ 
2:  $j_k \leftarrow n$ 
3: for  $1 \leq i \leq k - 1$  pardo
4:    $j_i \leftarrow \text{rank}(b_{i \log n} : A)$ 
5: for  $0 \leq i \leq k - 1$  pardo
6:    $B_i \leftarrow (b_{i \log n + 1}, \dots, b_{(i+1) \log n})$ 
7:    $A_i \leftarrow (a_{j_i + 1}, \dots, a_{j_{i+1}})$ 
```

If C_i is the merging of A_i and B_i then the sequence $C_0 \dots C_{k-1}$ is a sorted sequence.

4.3 Divide & Conquer — Merging

$A = (a_1, \dots, a_n); B = (b_1, \dots, b_n);$
log n integral; $k := n / \log n$ integral;

Algorithm 8 GenerateSubproblems

```
1:  $j_0 \leftarrow 0$ 
2:  $j_k \leftarrow n$ 
3: for  $1 \leq i \leq k - 1$  pardo
4:    $j_i \leftarrow \text{rank}(b_{i \log n} : A)$ 
5: for  $0 \leq i \leq k - 1$  pardo
6:    $B_i \leftarrow (b_{i \log n + 1}, \dots, b_{(i+1) \log n})$ 
7:    $A_i \leftarrow (a_{j_i + 1}, \dots, a_{j_{i+1}})$ 
```

If C_i is the merging of A_i and B_i then the sequence $C_0 \dots C_{k-1}$ is a sorted sequence.

4.3 Divide & Conquer — Merging

We can generate the subproblems in time $\mathcal{O}(\log n)$ and work $\mathcal{O}(n)$.

Note that in a sub-problem B_i has length $\log n$.

If we run the algorithm again for every subproblem, (where A_i takes the role of B) we can in time $\mathcal{O}(\log \log n)$ and work $\mathcal{O}(n)$ generate subproblems where A_j and B_j have both length at most $\log n$.

Such a subproblem can be solved by a single processor in time $\mathcal{O}(\log n)$ and work $\mathcal{O}(|A_i| + |B_i|)$.

Parallelizing the last step gives total work $\mathcal{O}(n)$ and time $\mathcal{O}(\log n)$.

the resulting algorithm is work optimal

4.3 Divide & Conquer — Merging

We can generate the subproblems in time $\mathcal{O}(\log n)$ and **work** $\mathcal{O}(n)$.

Note that in a sub-problem B_i has length $\log n$.

If we run the algorithm again for every subproblem, (where A_i takes the role of B) we can in time $\mathcal{O}(\log \log n)$ and work $\mathcal{O}(n)$ generate subproblems where A_j and B_j have both length at most $\log n$.

Such a subproblem can be solved by a single processor in time $\mathcal{O}(\log n)$ and work $\mathcal{O}(|A_i| + |B_i|)$.

Parallelizing the last step gives total work $\mathcal{O}(n)$ and time $\mathcal{O}(\log n)$.

the resulting algorithm is work optimal

4.3 Divide & Conquer — Merging

We can generate the subproblems in time $\mathcal{O}(\log n)$ and **work** $\mathcal{O}(n)$.

Note that in a sub-problem B_i has length $\log n$.

If we run the algorithm again for every subproblem, (where A_i takes the role of B) we can in time $\mathcal{O}(\log \log n)$ and work $\mathcal{O}(n)$ generate subproblems where A_j and B_j have both length at most $\log n$.

Such a subproblem can be solved by a single processor in time $\mathcal{O}(\log n)$ and work $\mathcal{O}(|A_i| + |B_i|)$.

Parallelizing the last step gives total work $\mathcal{O}(n)$ and time $\mathcal{O}(\log n)$.

the resulting algorithm is work optimal

4.3 Divide & Conquer — Merging

We can generate the subproblems in time $\mathcal{O}(\log n)$ and **work** $\mathcal{O}(n)$.

Note that in a sub-problem B_i has length $\log n$.

If we run the algorithm again for every subproblem, (where A_i takes the role of B) we can in time $\mathcal{O}(\log \log n)$ and work $\mathcal{O}(n)$ generate subproblems where A_j and B_j have both length at most $\log n$.

Such a subproblem can be solved by a single processor in time $\mathcal{O}(\log n)$ and work $\mathcal{O}(|A_i| + |B_i|)$.

Parallelizing the last step gives total work $\mathcal{O}(n)$ and time $\mathcal{O}(\log n)$.

the resulting algorithm is work optimal

4.3 Divide & Conquer — Merging

We can generate the subproblems in time $\mathcal{O}(\log n)$ and **work** $\mathcal{O}(n)$.

Note that in a sub-problem B_i has length $\log n$.

If we run the algorithm again for every subproblem, (where A_i takes the role of B) we can in time $\mathcal{O}(\log \log n)$ and work $\mathcal{O}(n)$ generate subproblems where A_j and B_j have both length at most $\log n$.

Such a subproblem can be solved by a single processor in time $\mathcal{O}(\log n)$ and work $\mathcal{O}(|A_i| + |B_i|)$.

Parallelizing the last step gives total work $\mathcal{O}(n)$ and time $\mathcal{O}(\log n)$.

the resulting algorithm is work optimal

4.3 Divide & Conquer — Merging

We can generate the subproblems in time $\mathcal{O}(\log n)$ and **work** $\mathcal{O}(n)$.

Note that in a sub-problem B_i has length $\log n$.

If we run the algorithm again for every subproblem, (where A_i takes the role of B) we can in time $\mathcal{O}(\log \log n)$ and work $\mathcal{O}(n)$ generate subproblems where A_j and B_j have both length at most $\log n$.

Such a subproblem can be solved by a single processor in time $\mathcal{O}(\log n)$ and work $\mathcal{O}(|A_i| + |B_i|)$.

Parallelizing the last step gives total work $\mathcal{O}(n)$ and time $\mathcal{O}(\log n)$.

the resulting algorithm is work optimal

4.4 Maximum Computation

Lemma 4

On a CRCW PRAM the maximum of n numbers can be computed in time $\mathcal{O}(1)$ with n^2 processors.

proof on board...

4.4 Maximum Computation

Lemma 4

On a CRCW PRAM the maximum of n numbers can be computed in time $\mathcal{O}(1)$ with n^2 processors.

proof on board...

4.4 Maximum Computation

Lemma 5

On a CRCW PRAM the maximum of n numbers can be computed in time $\mathcal{O}(\log \log n)$ with n processors and work $\mathcal{O}(n \log \log n)$.

proof on board...

4.4 Maximum Computation

Lemma 5

On a CRCW PRAM the maximum of n numbers can be computed in time $\mathcal{O}(\log \log n)$ with n processors and work $\mathcal{O}(n \log \log n)$.

proof on board...

4.4 Maximum Computation

Lemma 6

On a CRCW PRAM the maximum of n numbers can be computed in time $\mathcal{O}(\log \log n)$ with n processors and work $\mathcal{O}(n)$.

proof on board...

4.4 Maximum Computation

Lemma 6

On a CRCW PRAM the maximum of n numbers can be computed in time $\mathcal{O}(\log \log n)$ with n processors and work $\mathcal{O}(n)$.

proof on board...

4.5 Inserting into a (2, 3)-tree

Given a (2, 3)-tree with n elements, and a sequence $x_0 < x_1 < x_2 < \dots < x_k$ of elements. We want to insert elements x_1, \dots, x_k into the tree ($k \ll n$).

time: $\mathcal{O}(\log n)$; work: $\mathcal{O}(k \log n)$

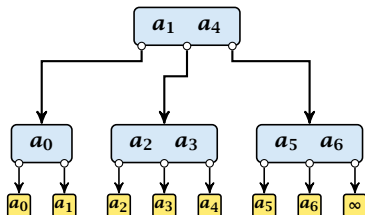

4.5 Inserting into a (2, 3)-tree

Given a (2, 3)-tree with n elements, and a sequence $x_0 < x_1 < x_2 < \dots < x_k$ of elements. We want to insert elements x_1, \dots, x_k into the tree ($k \ll n$).

time: $\mathcal{O}(\log n)$; **work:** $\mathcal{O}(k \log n)$

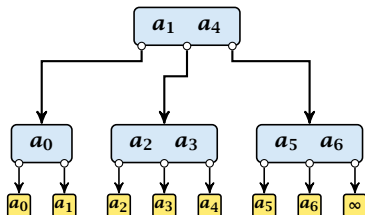

4.5 Inserting into a (2, 3)-tree

1. determine for every x_i the leaf element before which it has to be inserted
time: $\mathcal{O}(\log n)$; work: $\mathcal{O}(k \log n)$; **CREW PRAM**

all x_i 's that have to be inserted before the same element form a **chain**

2. determine the largest/smallest/middle element of every chain

time: $\mathcal{O}(\log k)$; work: $\mathcal{O}(k)$;

3. insert the middle element of every chain
compute new chains

time: $\mathcal{O}(\log n)$; work: $\mathcal{O}(k_i \log n + k)$; $k_i = \#$ inserted elements

(computing new chains is constant time)

4. repeat Step 3 for logarithmically many rounds

time: $\mathcal{O}(\log n \log k)$; work: $\mathcal{O}(k \log n)$;

4.5 Inserting into a (2, 3)-tree

1. determine for every x_i the leaf element before which it has to be inserted
time: $\mathcal{O}(\log n)$; work: $\mathcal{O}(k \log n)$; **CREW PRAM**
all x_i 's that have to be inserted before the same element form a **chain**
2. determine the largest/smallest/middle element of every chain
time: $\mathcal{O}(\log k)$; work: $\mathcal{O}(k)$;
3. insert the middle element of every chain
compute new chains
time: $\mathcal{O}(\log n)$; work: $\mathcal{O}(k_i \log n + k)$; $k_i = \#$ inserted elements
(computing new chains is constant time)
4. repeat Step 3 for logarithmically many rounds
time: $\mathcal{O}(\log n \log k)$; work: $\mathcal{O}(k \log n)$;

4.5 Inserting into a (2, 3)-tree

1. determine for every x_i the leaf element before which it has to be inserted
time: $\mathcal{O}(\log n)$; work: $\mathcal{O}(k \log n)$; **CREW PRAM**
all x_i 's that have to be inserted before the same element form a **chain**
2. determine the largest/smallest/middle element of every chain
time: $\mathcal{O}(\log k)$; work: $\mathcal{O}(k)$;
3. insert the middle element of every chain
compute new chains
time: $\mathcal{O}(\log n)$; work: $\mathcal{O}(k_i \log n + k)$; $k_i = \#$ inserted elements
(computing new chains is constant time)
4. repeat Step 3 for logarithmically many rounds
time: $\mathcal{O}(\log n \log k)$; work: $\mathcal{O}(k \log n)$;

4.5 Inserting into a (2, 3)-tree

1. determine for every x_i the leaf element before which it has to be inserted
time: $\mathcal{O}(\log n)$; work: $\mathcal{O}(k \log n)$; **CREW PRAM**
all x_i 's that have to be inserted before the same element form a **chain**
2. determine the largest/smallest/middle element of every chain
time: $\mathcal{O}(\log k)$; work: $\mathcal{O}(k)$;
3. insert the middle element of every chain
compute new chains
time: $\mathcal{O}(\log n)$; work: $\mathcal{O}(k_i \log n + k)$; $k_i = \#$ inserted elements
(computing new chains is constant time)
4. repeat Step 3 for logarithmically many rounds
time: $\mathcal{O}(\log n \log k)$; work: $\mathcal{O}(k \log n)$;

4.5 Inserting into a (2, 3)-tree

1. determine for every x_i the leaf element before which it has to be inserted
time: $\mathcal{O}(\log n)$; work: $\mathcal{O}(k \log n)$; **CREW PRAM**
all x_i 's that have to be inserted before the same element form a **chain**
2. determine the largest/smallest/middle element of every chain
time: $\mathcal{O}(\log k)$; work: $\mathcal{O}(k)$;
3. insert the middle element of every chain
compute new chains
time: $\mathcal{O}(\log n)$; work: $\mathcal{O}(k_i \log n + k)$; $k_i = \#$ inserted elements
(computing new chains is constant time)
4. repeat Step 3 for logarithmically many rounds
time: $\mathcal{O}(\log n \log k)$; work: $\mathcal{O}(k \log n)$;

Step 3

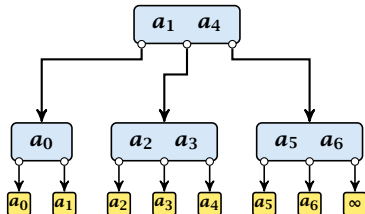

Step 3

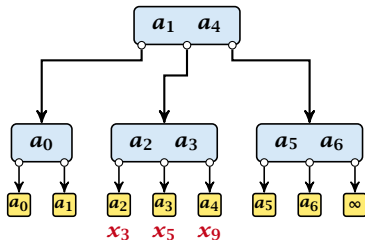

Step 3

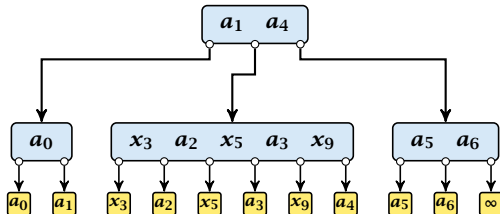

Step 3

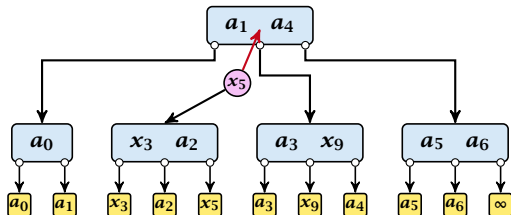

Step 3

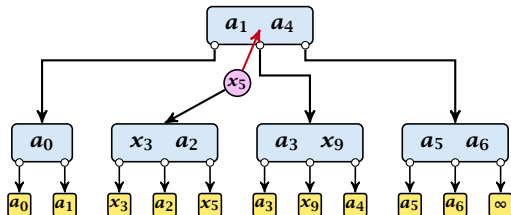

- ▶ each internal node is split into at most two parts

Step 3

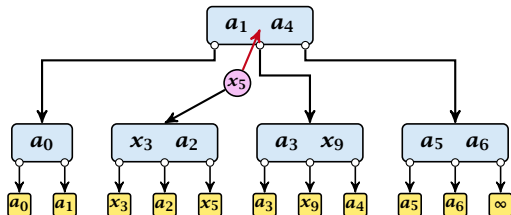

- ▶ each internal node is split into at most two parts
- ▶ each split operation promotes at most one element

Step 3

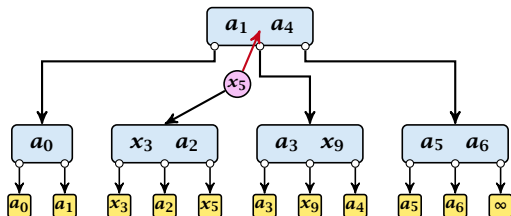

- ▶ each internal node is split into at most two parts
- ▶ each split operation promotes at most one element
- ▶ hence, on every level we want to insert at most one element per successor pointer

Step 3

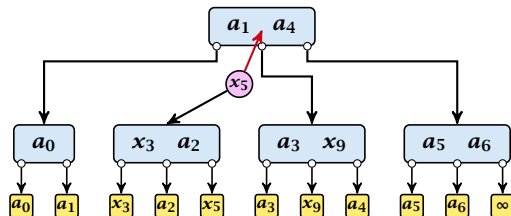

- ▶ each internal node is split into at most two parts
- ▶ each split operation promotes at most one element
- ▶ hence, on every level we want to insert at most one element per successor pointer
- ▶ we can use the same routine for every level

4.5 Inserting into a (2, 3)-tree

- ▶ Step 3, works in phases; one phase for every level of the tree
- ▶ Step 4, works in rounds; in each round a different set of elements is inserted

Observation

We can start with phase i of round r as long as phase i of round $r - 1$ and (of course), phase $i - 1$ of round r has finished.

This is called **Pipelining**. Using this technique we can perform all rounds in Step 4 in just $\mathcal{O}(\log k + \log n)$ many parallel steps.

4.5 Inserting into a (2, 3)-tree

- ▶ Step 3, works in phases; one phase for every level of the tree
- ▶ Step 4, works in rounds; in each round a different set of elements is inserted

Observation

We can start with phase i of round r as long as phase i of round $r - 1$ and (of course), phase $i - 1$ of round r has finished.

This is called **Pipelining**. Using this technique we can perform all rounds in Step 4 in just $\mathcal{O}(\log k + \log n)$ many parallel steps.

4.5 Inserting into a (2, 3)-tree

- ▶ Step 3, works in phases; one phase for every level of the tree
- ▶ Step 4, works in rounds; in each round a different set of elements is inserted

Observation

We can start with phase i of round r as long as phase i of round $r - 1$ and (of course), phase $i - 1$ of round r has finished.

This is called **Pipelining**. Using this technique we can perform all rounds in Step 4 in just $\mathcal{O}(\log k + \log n)$ many parallel steps.

4.5 Inserting into a (2, 3)-tree

- ▶ Step 3, works in phases; one phase for every level of the tree
- ▶ Step 4, works in rounds; in each round a different set of elements is inserted

Observation

We can start with phase i of round r as long as phase i of round $r - 1$ and (of course), phase $i - 1$ of round r has finished.

This is called **Pipelining**. Using this technique we can perform all rounds in Step 4 in just $\mathcal{O}(\log k + \log n)$ many parallel steps.

4.6 Symmetry Breaking

The following algorithm colors an n -node cycle with $\lceil \log n \rceil$ colors.

Algorithm 9 BasicColoring

- 1: **for** $1 \leq i \leq n$ **pardo**
- 2: $\text{col}(i) \leftarrow i$
- 3: $k_i \leftarrow$ smallest bitpos where $\text{col}(i)$ and $\text{col}(S(i))$ differ
- 4: $\text{col}'(i) \leftarrow 2k_i + \text{col}(i)_{k_i}$

(bit positions are numbered starting with 0)

4.6 Symmetry Breaking

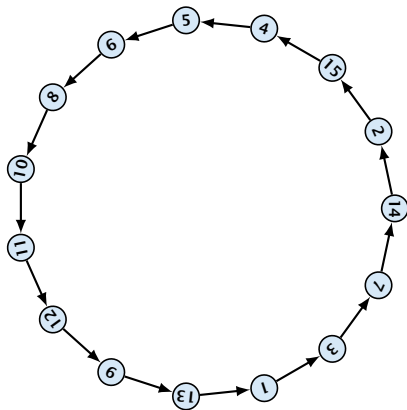

v	col	k	col'
1	0001	1	2
3	0011	2	4
7	0111	0	1
14	1110	2	5
2	0010	0	0
15	1111	0	1
4	0100	0	0
5	0101	0	1
6	0110	1	3
8	1000	1	2
10	1010	0	0
11	1011	0	1
12	1100	0	0
9	1001	2	4
13	1101	2	5

4.6 Symmetry Breaking

Applying the algorithm to a coloring with bit-length t generates a coloring with largest color at most

$$2(t - 1) + 1$$

and bit-length at most

$$\lceil \log_2(2(t - 1) + 1) \rceil = \lceil \log_2(2t) \rceil = \lceil \log_2 t \rceil + 1$$

Applying the algorithm repeatedly generates a constant number of colors after $\mathcal{O}(\log^* n)$ operations.

4.6 Symmetry Breaking

Applying the algorithm to a coloring with bit-length t generates a coloring with largest color at most

$$2(t - 1) + 1$$

and bit-length at most

$$\lceil \log_2(2(t - 1) + 1) \rceil \leq \lceil \log_2(2t) \rceil = \lceil \log_2(t) \rceil + 1$$

Applying the algorithm repeatedly generates a constant number of colors after $\mathcal{O}(\log^* n)$ operations.

4.6 Symmetry Breaking

Applying the algorithm to a coloring with bit-length t generates a coloring with largest color at most

$$2(t - 1) + 1$$

and bit-length at most

$$\lceil \log_2(2(t - 1) + 1) \rceil \leq \lceil \log_2(2t) \rceil = \lceil \log_2(t) \rceil + 1$$

Applying the algorithm repeatedly generates a constant number of colors after $\mathcal{O}(\log^* n)$ operations.

4.6 Symmetry Breaking

Applying the algorithm to a coloring with bit-length t generates a coloring with largest color at most

$$2(t - 1) + 1$$

and bit-length at most

$$\lceil \log_2(2(t - 1) + 1) \rceil \leq \lceil \log_2(2t) \rceil = \lceil \log_2(t) \rceil + 1$$

Applying the algorithm repeatedly generates a constant number of colors after $\mathcal{O}(\log^* n)$ operations.

4.6 Symmetry Breaking

Applying the algorithm to a coloring with bit-length t generates a coloring with largest color at most

$$2(t - 1) + 1$$

and bit-length at most

$$\lceil \log_2(2(t - 1) + 1) \rceil \leq \lceil \log_2(2t) \rceil = \lceil \log_2(t) \rceil + 1$$

Applying the algorithm repeatedly generates a constant number of colors after $\mathcal{O}(\log^* n)$ operations.

4.6 Symmetry Breaking

As long as the bit-length $t \geq 4$ the bit-length decreases.

Applying the algorithm with bit-length 3 gives a coloring with colors in the range $0, \dots, 5 = 2t - 1$.

We can improve to a 3-coloring by successively re-coloring nodes from a color-class:

Algorithm 10 ReColor

```
1: for  $\ell \leftarrow 5$  to 3
2:   for  $1 \leq i \leq n$  pardo
3:     if  $\text{col}(i) = \ell$  then
4:        $\text{col}(i) \leftarrow \min\{\{0, 1, 2\} \setminus \{\text{col}(P[i]), \text{col}(S[i])\}\}$ 
```

This requires time $\mathcal{O}(1)$ and work $\mathcal{O}(n)$.

4.6 Symmetry Breaking

As long as the bit-length $t \geq 4$ the bit-length decreases.

Applying the algorithm with bit-length 3 gives a coloring with colors in the range $0, \dots, 5 = 2t - 1$.

We can improve to a 3-coloring by successively re-coloring nodes from a color-class:

Algorithm 10 ReColor

```
1: for  $\ell \leftarrow 5$  to 3
2:   for  $1 \leq i \leq n$  pardo
3:     if  $\text{col}(i) = \ell$  then
4:        $\text{col}(i) \leftarrow \min\{\{0, 1, 2\} \setminus \{\text{col}(P[i]), \text{col}(S[i])\}\}$ 
```

This requires time $\mathcal{O}(1)$ and work $\mathcal{O}(n)$.

4.6 Symmetry Breaking

As long as the bit-length $t \geq 4$ the bit-length decreases.

Applying the algorithm with bit-length 3 gives a coloring with colors in the range $0, \dots, 5 = 2t - 1$.

We can improve to a 3-coloring by successively re-coloring nodes from a color-class:

Algorithm 10 ReColor

```
1: for  $\ell \leftarrow 5$  to 3
2:   for  $1 \leq i \leq n$  pardo
3:     if  $\text{col}(i) = \ell$  then
4:        $\text{col}(i) \leftarrow \min\{\{0, 1, 2\} \setminus \{\text{col}(P[i]), \text{col}(S[i])\}\}$ 
```

This requires time $\mathcal{O}(1)$ and work $\mathcal{O}(n)$.

4.6 Symmetry Breaking

As long as the bit-length $t \geq 4$ the bit-length decreases.

Applying the algorithm with bit-length 3 gives a coloring with colors in the range $0, \dots, 5 = 2t - 1$.

We can improve to a 3-coloring by successively re-coloring nodes from a color-class:

Algorithm 10 ReColor

```
1: for  $\ell \leftarrow 5$  to 3
2:   for  $1 \leq i \leq n$  pardo
3:     if  $\text{col}(i) = \ell$  then
4:        $\text{col}(i) \leftarrow \min\{\{0, 1, 2\} \setminus \{\text{col}(P[i]), \text{col}(S[i])\}\}$ 
```

This requires time $\mathcal{O}(1)$ and work $\mathcal{O}(n)$.

4.6 Symmetry Breaking

Lemma 7

We can color vertices in a ring with three colors in $\mathcal{O}(\log^ n)$ time and with $\mathcal{O}(n \log^* n)$ work.*

not work optimal

4.6 Symmetry Breaking

Lemma 8

Given n integers in the range $0, \dots, \mathcal{O}(\log n)$, there is an algorithm that sorts these numbers in $\mathcal{O}(\log n)$ time using a linear number of operations.

Proof: Exercise!

4.6 Symmetry Breaking

Algorithm 11 OptColor

```
1: for  $1 \leq i \leq n$  pardo
2:    $\text{col}(i) \leftarrow i$ 
3:   apply BasicColoring once
4:   sort vertices by colors
5:   for  $\ell = 2^{\lceil \log n \rceil}$  to 3 do
6:     for all vertices  $i$  of color  $\ell$  pardo
7:        $\text{col}(i) \leftarrow \min\{\{0, 1, 2\} \setminus \{\text{col}(P[i]), \text{col}(S[i])\}\}$ 
```

Lemma 9

A ring can be colored with 3 colors in time $\mathcal{O}(\log n)$ and with work $\mathcal{O}(n)$.

work optimal but not too fast

List Ranking

Input:

A list given by successor pointers;

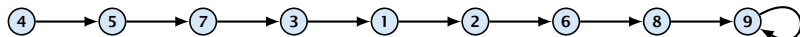

Output:

For every node number of hops to end of the list;

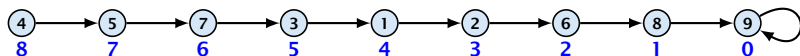

Observation:

Special case of parallel prefix

List Ranking

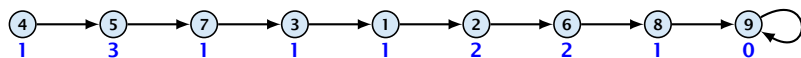

1. Given a list with values; perhaps from previous iterations.

The list is given via predecessor pointers $P(i)$ and successor pointers $S(i)$.

$S(4) = 5, S(2) = 6, P(3) = 7$, etc.

List Ranking

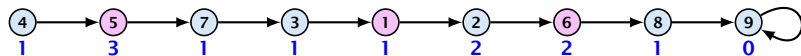

2. Find an independent set; time: $\mathcal{O}(\log n)$; work: $\mathcal{O}(n)$.

The independent set should contain a constant fraction of the vertices.

Color vertices; take local minima

List Ranking

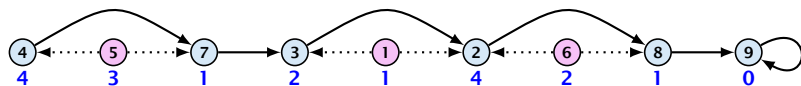

3. Splice the independent set out of the list;

At the independent set vertices the array still contains old values for $P(i)$ and $S(i)$;

List Ranking

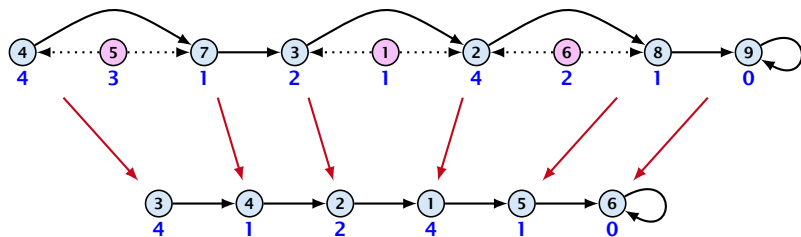

4. Compress remaining n' nodes into a new array of n' entries.

The index positions can be computed by a prefix sum in time $\mathcal{O}(\log n)$ and work $\mathcal{O}(n)$

Pointers can then be adjusted in time $\mathcal{O}(1)$.

List Ranking

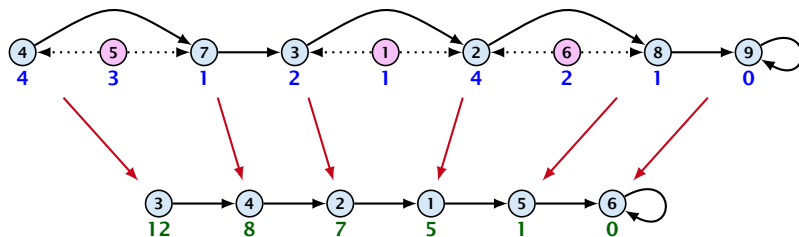

5. Solve the problem on the remaining list.

If current size is less than $n/\log n$ do pointer jumping:
time $\mathcal{O}(\log n)$; work $\mathcal{O}(n)$.

Otherwise continue shrinking the list by finding an
independent set

List Ranking

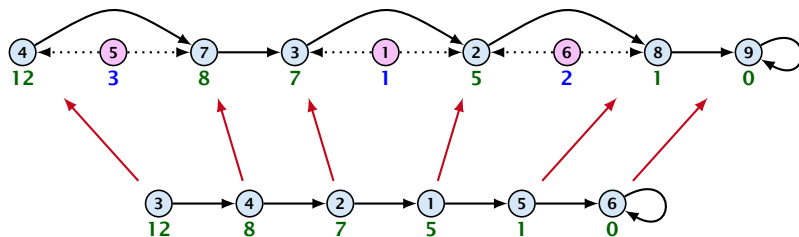

6. Map the values back into the larger list. Time: $\mathcal{O}(1)$;
Work: $\mathcal{O}(n)$

List Ranking

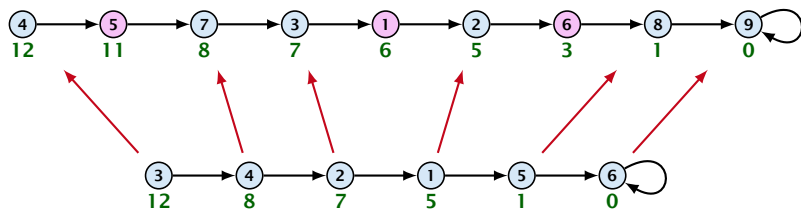

7. Compute values for independent set nodes. Time: $\mathcal{O}(1)$; Work: $\mathcal{O}(1)$.
8. Splice nodes back into list. Time: $\mathcal{O}(1)$; Work: $\mathcal{O}(1)$.

List Ranking

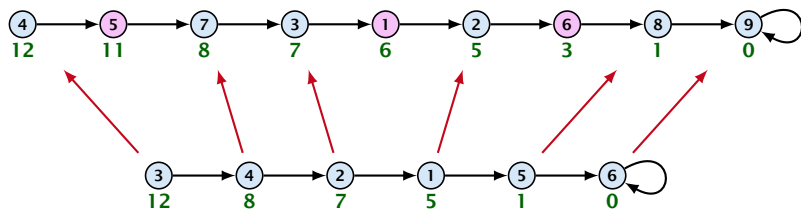

We need $\mathcal{O}(\log \log n)$ shrinking iterations until the size of the remaining list reaches $\mathcal{O}(n / \log n)$.

Each shrinking iteration takes time $\mathcal{O}(\log n)$.

The work for all shrinking operations is just $\mathcal{O}(n)$, as the size of the list goes down by a constant factor in each round.

List Ranking can be solved in time $\mathcal{O}(\log n \log \log n)$ and work $\mathcal{O}(n)$ on an EREW-PRAM.

We need $\mathcal{O}(\log \log n)$ shrinking iterations until the size of the remaining list reaches $\mathcal{O}(n / \log n)$.

Each shrinking iteration takes time $\mathcal{O}(\log n)$.

The work for all shrinking operations is just $\mathcal{O}(n)$, as the size of the list goes down by a constant factor in each round.

List Ranking can be solved in time $\mathcal{O}(\log n \log \log n)$ and work $\mathcal{O}(n)$ on an EREW-PRAM.

We need $\mathcal{O}(\log \log n)$ shrinking iterations until the size of the remaining list reaches $\mathcal{O}(n / \log n)$.

Each shrinking iteration takes time $\mathcal{O}(\log n)$.

The work for all shrinking operations is just $\mathcal{O}(n)$, as the size of the list goes down by a constant factor in each round.

List Ranking can be solved in time $\mathcal{O}(\log n \log \log n)$ and work $\mathcal{O}(n)$ on an EREW-PRAM.

We need $\mathcal{O}(\log \log n)$ shrinking iterations until the size of the remaining list reaches $\mathcal{O}(n / \log n)$.

Each shrinking iteration takes time $\mathcal{O}(\log n)$.

The work for all shrinking operations is just $\mathcal{O}(n)$, as the size of the list goes down by a constant factor in each round.

List Ranking can be solved in time $\mathcal{O}(\log n \log \log n)$ and work $\mathcal{O}(n)$ on an EREW-PRAM.

Optimal List Ranking

In order to reduce the work we have to improve the shrinking of the list to $\mathcal{O}(n/\log n)$ nodes.

After this we apply pointer jumping

Optimal List Ranking

In order to reduce the work we have to improve the shrinking of the list to $\mathcal{O}(n/\log n)$ nodes.

After this we apply pointer jumping

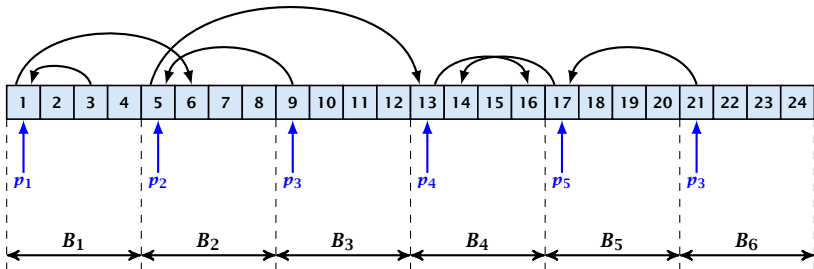

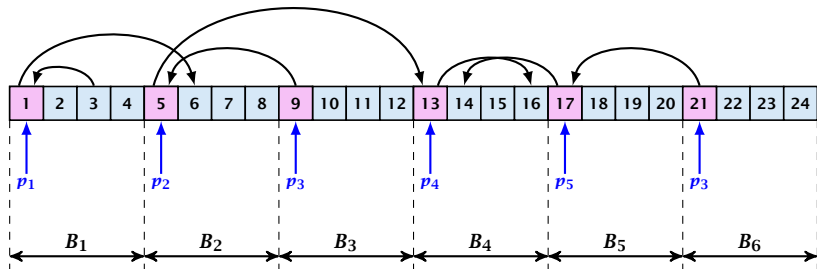

- ▶ some nodes are **active**;
- ▶ active nodes without neighbouring active nodes are **isolated**;
- ▶ the others form sublists;

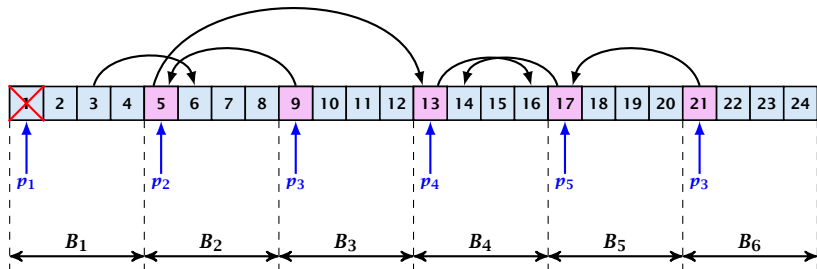

1 delete isolated nodes from the list;

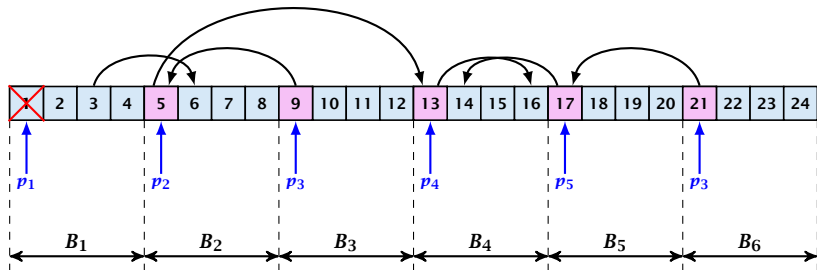

- 1 delete isolated nodes from the list;
- 2 color each sublist with $\mathcal{O}(\log \log n)$ colors; time: $\mathcal{O}(1)$;
work: $\mathcal{O}(n)$;

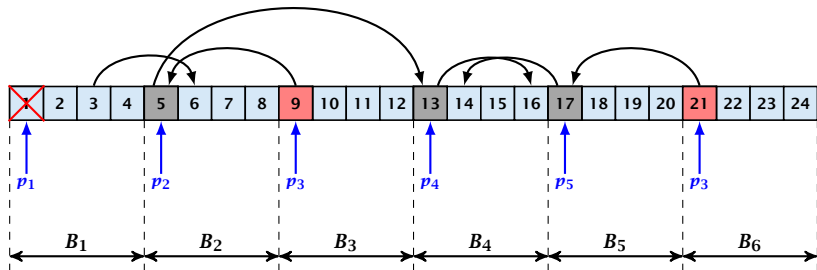

- 1 delete isolated nodes from the list;
 - 2 color each sublist with $\mathcal{O}(\log \log n)$ colors; time: $\mathcal{O}(1)$; work: $\mathcal{O}(n)$;
- label local minima w.r.t. color as **ruler**; others as **subject**
 first node of sublist is ruler; **needs to be changed!!!**

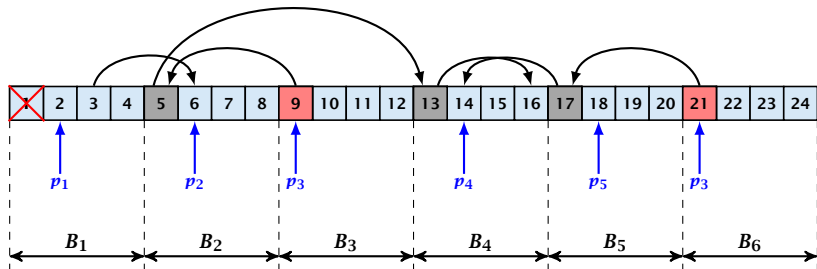

3 advance pointers of removed nodes and of subjects;

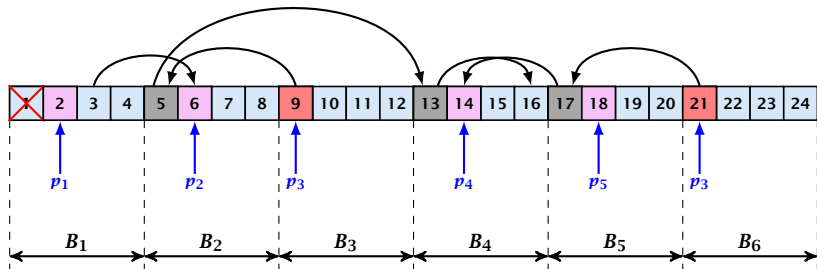

3 advance pointers of removed nodes and of subjects;
make new nodes active

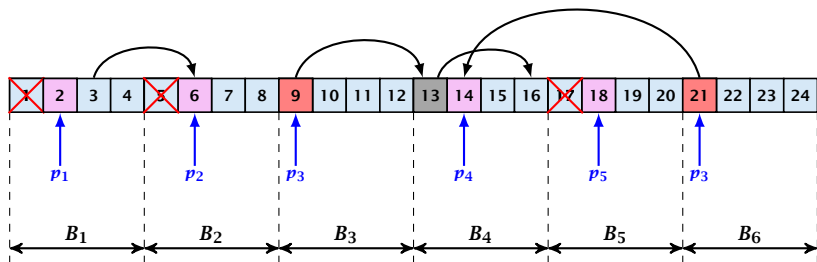

New Iteration

0. every ruler deletes its next subject;
rulers without a subject become active

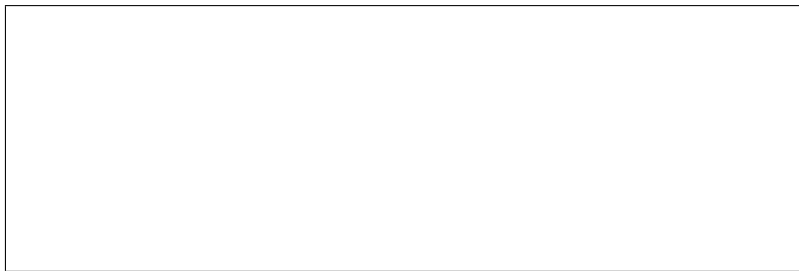
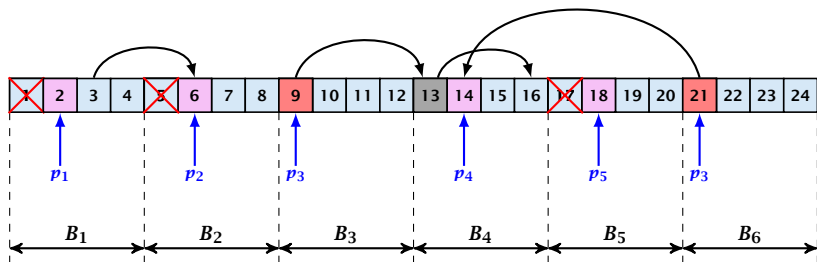

Optimal List Ranking

Each iteration requires constant time and work $\mathcal{O}(n/\log n)$, because we just work on one node in every block.

We need to prove that we just require $\mathcal{O}(\log n)$ iterations to reduce the size of the list to $\mathcal{O}(n/\log n)$.

Optimal List Ranking

Each iteration requires constant time and work $\mathcal{O}(n/\log n)$, because we just work on one node in every block.

We need to prove that we just require $\mathcal{O}(\log n)$ iterations to reduce the size of the list to $\mathcal{O}(n/\log n)$.

Observations/Remarks:

- ▶ If the p -pointer of a block cannot be advanced without leaving the block, the processor responsible for this block simply stops working; all other blocks continue.
- ▶ The p -node of a block (the node p_i is pointing to) at the beginning of a round is either a ruler with a living subject or the node will become active during the round.
- ▶ The subject nodes always lie to the left of the p -node of the respective block (if it exists).

Measure of Progress:

- ▶ A ruler will always advance its p -pointer.
- ▶ A subject will always advance its p -pointer.

Observations/Remarks:

- ▶ If the p -pointer of a block cannot be advanced without leaving the block, the processor responsible for this block simply stops working; all other blocks continue.
- ▶ The p -node of a block (the node p_i is pointing to) at the beginning of a round is either a ruler with a living subject or the node will become active during the round.
- ▶ The subject nodes always lie to the left of the p -node of the respective block (if it exists).

Measure of Progress:

Observations/Remarks:

- ▶ If the p -pointer of a block cannot be advanced without leaving the block, the processor responsible for this block simply stops working; all other blocks continue.
- ▶ The p -node of a block (the node p_i is pointing to) at the beginning of a round is either a ruler with a living subject or the node will become active during the round.
- ▶ The subject nodes always lie to the left of the p -node of the respective block (if it exists).

Measure of Progress:

Observations/Remarks:

- ▶ If the p -pointer of a block cannot be advanced without leaving the block, the processor responsible for this block simply stops working; all other blocks continue.
- ▶ The p -node of a block (the node p_i is pointing to) at the beginning of a round is either a ruler with a living subject or the node will become active during the round.
- ▶ The subject nodes always lie to the left of the p -node of the respective block (if it exists).

Measure of Progress:

- ▶ a ruler will delete a subject
- ▶ an active node either

Observations/Remarks:

- ▶ If the p -pointer of a block cannot be advanced without leaving the block, the processor responsible for this block simply stops working; all other blocks continue.
- ▶ The p -node of a block (the node p_i is pointing to) at the beginning of a round is either a ruler with a living subject or the node will become active during the round.
- ▶ The subject nodes always lie to the left of the p -node of the respective block (if it exists).

Measure of Progress:

- ▶ a ruler will delete a subject
- ▶ an active node either
 - ▶ becomes a ruler (with a subject)
 - ▶ becomes a subject
 - ▶ is isolated and therefore gets deleted

Observations/Remarks:

- ▶ If the p -pointer of a block cannot be advanced without leaving the block, the processor responsible for this block simply stops working; all other blocks continue.
- ▶ The p -node of a block (the node p_i is pointing to) at the beginning of a round is either a ruler with a living subject or the node will become active during the round.
- ▶ The subject nodes always lie to the left of the p -node of the respective block (if it exists).

Measure of Progress:

- ▶ a ruler will delete a subject
- ▶ an active node either
 - ▶ becomes a ruler (with a subject)
 - ▶ becomes a subject
 - ▶ is isolated and therefore gets deleted

Observations/Remarks:

- ▶ If the p -pointer of a block cannot be advanced without leaving the block, the processor responsible for this block simply stops working; all other blocks continue.
- ▶ The p -node of a block (the node p_i is pointing to) at the beginning of a round is either a ruler with a living subject or the node will become active during the round.
- ▶ The subject nodes always lie to the left of the p -node of the respective block (if it exists).

Measure of Progress:

- ▶ a ruler will delete a subject
- ▶ an active node either
 - ▶ becomes a ruler (with a subject)
 - ▶ becomes a subject
 - ▶ is isolated and therefore gets deleted

Observations/Remarks:

- ▶ If the p -pointer of a block cannot be advanced without leaving the block, the processor responsible for this block simply stops working; all other blocks continue.
- ▶ The p -node of a block (the node p_i is pointing to) at the beginning of a round is either a ruler with a living subject or the node will become active during the round.
- ▶ The subject nodes always lie to the left of the p -node of the respective block (if it exists).

Measure of Progress:

- ▶ a ruler will delete a subject
- ▶ an active node either
 - ▶ becomes a ruler (with a subject)
 - ▶ becomes a subject
 - ▶ is isolated and therefore gets deleted

Analysis

For the analysis we assign a weight to every node in every block as follows.

Definition 10

The **weight** of the i -th node in a block is

$$(1 - q)^i$$

with $q = \frac{1}{\log \log n}$, where the node-numbering starts from 0.
Hence, a block has nodes $\{0, \dots, \log n - 1\}$.

Analysis

For the analysis we assign a weight to every node in every block as follows.

Definition 10

The **weight** of the i -th node in a block is

$$(1 - q)^i$$

with $q = \frac{1}{\log \log n}$, where the node-numbering starts from 0.
Hence, a block has nodes $\{0, \dots, \log n - 1\}$.

Definition of Rulers

Properties:

- ▶ A ruler should have at most $\log \log n$ subjects.
- ▶ The weight of a ruler should be at most the weight of any of its subjects.
- ▶ Each ruler must have at least one subject.
- ▶ We must be able to remove the **next subject** in constant time.
- ▶ We need to make the ruler/subject decision in constant time.

Definition of Rulers

Properties:

- ▶ A ruler should have at most $\log \log n$ subjects.
- ▶ The weight of a ruler should be at most the weight of any of its subjects.
- ▶ Each ruler must have at least one subject.
- ▶ We must be able to remove the **next subject** in constant time.
- ▶ We need to make the ruler/subject decision in constant time.

Definition of Rulers

Properties:

- ▶ A ruler should have at most $\log \log n$ subjects.
- ▶ The weight of a ruler should be at most the weight of any of its subjects.
- ▶ Each ruler must have at least one subject.
- ▶ We must be able to remove the **next subject** in constant time.
- ▶ We need to make the ruler/subject decision in constant time.

Definition of Rulers

Properties:

- ▶ A ruler should have at most $\log \log n$ subjects.
- ▶ The weight of a ruler should be at most the weight of any of its subjects.
- ▶ Each ruler must have at least one subject.
- ▶ We must be able to remove the **next subject** in constant time.
- ▶ We need to make the ruler/subject decision in constant time.

Definition of Rulers

Properties:

- ▶ A ruler should have at most $\log \log n$ subjects.
- ▶ The weight of a ruler should be at most the weight of any of its subjects.
- ▶ Each ruler must have at least one subject.
- ▶ We must be able to remove the **next subject** in constant time.
- ▶ We need to make the ruler/subject decision in constant time.

Given a sublist of active nodes.

Color the sublist with $\mathcal{O}(\log \log n)$ colors. Take the local minima w.r.t. this coloring.

If the first node is not a ruler

and the second node is a ruler switch ruler status between first and second

otherwise just make the first node into a ruler

This partitions the sub-list into **chains** of length at most $\log \log n$ each starting with a ruler

Given a sublist of active nodes.

Color the sublist with $\mathcal{O}(\log \log n)$ colors. Take the local minima w.r.t. this coloring.

If the first node is not a ruler

- If the second node is a ruler switch roles between first and second
- If not, just make the first node into a ruler

This partitions the sub-list into **chains** of length at most $\log \log n$ each starting with a ruler

Given a sublist of active nodes.

Color the sublist with $\mathcal{O}(\log \log n)$ colors. Take the local minima w.r.t. this coloring.

If the first node is not a ruler

- ▶ if the second node is a ruler switch ruler status between first and second
- ▶ otw. just make the first node into a ruler

This partitions the sub-list into chains of length at most $\log \log n$ each starting with a ruler

Given a sublist of active nodes.

Color the sublist with $\mathcal{O}(\log \log n)$ colors. Take the local minima w.r.t. this coloring.

If the first node is not a ruler

- ▶ if the second node is a ruler switch ruler status between first and second
- ▶ otw. just make the first node into a ruler

This partitions the sub-list into chains of length at most $\log \log n$ each starting with a ruler

Given a sublist of active nodes.

Color the sublist with $\mathcal{O}(\log \log n)$ colors. Take the local minima w.r.t. this coloring.

If the first node is not a ruler

- ▶ if the second node is a ruler switch ruler status between first and second
- ▶ otw. just make the first node into a ruler

This partitions the sub-list into **chains of length at most $\log \log n$ each starting with a ruler**

Now we change the ruler definition.

Consider some chain.

We make all local minima w.r.t. the weight function into a ruler; ties are broken according to block-id (so that comparing weights gives a strict inequality).

A ruler gets as subjects the nodes left of it until the next local maximum (or the start of the chain) (including the local maximum) and the nodes right of it until the next local maximum (or the end of the chain) (excluding the local maximum).

In case the first node is a ruler the above definition could leave it without a subject. We use constant time to fix this in some arbitrary manner

Now we change the ruler definition.

Consider some chain.

We make all local minima w.r.t. the weight function into a ruler; ties are broken according to block-id (so that comparing weights gives a strict inequality).

A ruler gets as subjects the nodes left of it until the next local maximum (or the start of the chain) (including the local maximum) and the nodes right of it until the next local maximum (or the end of the chain) (excluding the local maximum).

In case the first node is a ruler the above definition could leave it without a subject. We use constant time to fix this in some arbitrary manner

Now we change the ruler definition.

Consider some chain.

We make all local minima w.r.t. the weight function into a ruler; ties are broken according to block-id (so that comparing weights gives a strict inequality).

A ruler gets as subjects the nodes left of it until the next local maximum (or the start of the chain) (including the local maximum) and the nodes right of it until the next local maximum (or the end of the chain) (excluding the local maximum).

In case the first node is a ruler the above definition could leave it without a subject. We use constant time to fix this in some arbitrary manner

Now we change the ruler definition.

Consider some chain.

We make all local minima w.r.t. the weight function into a ruler; ties are broken according to block-id (so that comparing weights gives a strict inequality).

A ruler gets as subjects the nodes left of it until the next local maximum (or the start of the chain) (including the local maximum) and the nodes right of it until the next local maximum (or the end of the chain) (excluding the local maximum).

In case the first node is a ruler the above definition could leave it without a subject. We use constant time to fix this in some arbitrary manner

Now we change the ruler definition.

Consider some chain.

We make all local minima w.r.t. the weight function into a ruler; ties are broken according to block-id (so that comparing weights gives a strict inequality).

A ruler gets as subjects the nodes left of it until the next local maximum (or the start of the chain) (including the local maximum) and the nodes right of it until the next local maximum (or the end of the chain) (excluding the local maximum).

In case the first node is a ruler the above definition could leave it without a subject. We use constant time to fix this in some arbitrary manner

Set $q = \frac{1}{\log \log n}$.

The i -th node in a block is assigned a weight of $(1 - q)^i$,
 $0 \leq i < \log n$

The total weight of a block is at most $1/q$ and the total weight of
all items is at most $\frac{n}{q \log n}$.

to show:

After $\mathcal{O}(\log n)$ iterations the weight is at most
 $(n / \log n)(1 - q)^{\log n}$

This means at most $n / \log n$ nodes remain because the smallest
weight a node can have is $(1 - q)^{\log n - 1}$.

Set $q = \frac{1}{\log \log n}$.

The i -th node in a block is assigned a weight of $(1 - q)^i$,
 $0 \leq i < \log n$

The total weight of a block is at most $1/q$ and the total weight of all items is at most $\frac{n}{q \log n}$.

to show:

After $\mathcal{O}(\log n)$ iterations the weight is at most
 $(n / \log n)(1 - q)^{\log n}$

This means at most $n / \log n$ nodes remain because the smallest weight a node can have is $(1 - q)^{\log n - 1}$.

Set $q = \frac{1}{\log \log n}$.

The i -th node in a block is assigned a weight of $(1 - q)^i$,
 $0 \leq i < \log n$

The total weight of a block is at most $1/q$ and the total weight of all items is at most $\frac{n}{q \log n}$.

to show:

After $\mathcal{O}(\log n)$ iterations the weight is at most
 $(n / \log n)(1 - q)^{\log n}$

This means at most $n / \log n$ nodes remain because the smallest weight a node can have is $(1 - q)^{\log n - 1}$.

Set $q = \frac{1}{\log \log n}$.

The i -th node in a block is assigned a weight of $(1 - q)^i$,
 $0 \leq i < \log n$

The total weight of a block is at most $1/q$ and the total weight of all items is at most $\frac{n}{q \log n}$.

to show:

After $\mathcal{O}(\log n)$ iterations the weight is at most
 $(n / \log n)(1 - q)^{\log n}$

This means at most $n / \log n$ nodes remain because the smallest weight a node can have is $(1 - q)^{\log n - 1}$.

Set $q = \frac{1}{\log \log n}$.

The i -th node in a block is assigned a weight of $(1 - q)^i$,
 $0 \leq i < \log n$

The total weight of a block is at most $1/q$ and the total weight of all items is at most $\frac{n}{q \log n}$.

to show:

After $\mathcal{O}(\log n)$ iterations the weight is at most
 $(n / \log n)(1 - q)^{\log n}$

This means at most $n / \log n$ nodes remain because the smallest weight a node can have is $(1 - q)^{\log n - 1}$.

In every iteration the weight drops by a factor of

$$(1 - q/4) .$$

We consider subject nodes to just have half their weight.

We can view the step of becoming a subject as a precursor to deletion.

Hence, a node loses half its weight when becoming a subject and the remaining half when deleted.

Note that subject nodes will be deleted after just an additional $\mathcal{O}(\log \log n)$ iterations.

We consider subject nodes to just have half their weight.

We can view the step of becoming a subject as a precursor to deletion.

Hence, a node loses half its weight when becoming a subject and the remaining half when deleted.

Note that subject nodes will be deleted after just an additional $\mathcal{O}(\log \log n)$ iterations.

We consider subject nodes to just have half their weight.

We can view the step of becoming a subject as a precursor to deletion.

Hence, a node loses half its weight when becoming a subject and the remaining half when deleted.

Note that subject nodes will be deleted after just an additional $\mathcal{O}(\log \log n)$ iterations.

We consider subject nodes to just have half their weight.

We can view the step of becoming a subject as a precursor to deletion.

Hence, a node loses half its weight when becoming a subject and the remaining half when deleted.

Note that subject nodes will be deleted after just an additional $\mathcal{O}(\log \log n)$ iterations.

We consider subject nodes to just have half their weight.

We can view the step of becoming a subject as a precursor to deletion.

Hence, a node loses half its weight when becoming a subject and the remaining half when deleted.

Note that subject nodes will be deleted after just an additional $\mathcal{O}(\log \log n)$ iterations.

The weight is reduced because

- An isolated node is removed.
- A node is labelled as ruler, and the corresponding subjects reduce their weight by a factor of $1/2$.
- A node is a ruler and deletes one of its subjects.

Hence, the weight reduction comes from *p-nodes* (ruler/active).

The weight is reduced because

- ▶ An isolated node is removed.
- ▶ A node is labelled as ruler, and the corresponding subjects reduce their weight by a factor of $1/2$.
- ▶ A node is a ruler and deletes one of its subjects.

Hence, the weight reduction comes from *p-nodes* (ruler/active).

The weight is reduced because

- ▶ An isolated node is removed.
- ▶ A node is labelled as ruler, and the corresponding subjects reduce their weight by a factor of $1/2$.
- ▶ A node is a ruler and deletes one of its subjects.

Hence, the weight reduction comes from *p-nodes* (ruler/active).

The weight is reduced because

- ▶ An isolated node is removed.
- ▶ A node is labelled as ruler, and the corresponding subjects reduce their weight by a factor of $1/2$.
- ▶ A node is a ruler and deletes one of its subjects.

Hence, the weight reduction comes from *p-nodes* (ruler/active).

The weight is reduced because

- ▶ An isolated node is removed.
- ▶ A node is labelled as ruler, and the corresponding subjects reduce their weight by a factor of $1/2$.
- ▶ A node is a ruler and deletes one of its subjects.

Hence, the weight reduction comes from *p-nodes* (ruler/active).

Each p -node is **responsible** for some other nodes; it has to generate a weight reduction large enough so that the weight of all nodes it is responsible for decreases by the desired factor.

An active node is responsible for all nodes that come after it in its block.

A ruler is responsible for all nodes that come after it in its block and for all its subjects.

Note that by this definition every node remaining in the list is covered.

Each p -node is **responsible** for some other nodes; it has to generate a weight reduction large enough so that the weight of all nodes it is responsible for decreases by the desired factor.

An active node is responsible for all nodes that come after it in its block.

A ruler is responsible for all nodes that come after it in its block and for all its subjects.

Note that by this definition every node remaining in the list is covered.

Each p -node is **responsible** for some other nodes; it has to generate a weight reduction large enough so that the weight of all nodes it is responsible for decreases by the desired factor.

An active node is responsible for all nodes that come after it in its block.

A ruler is responsible for all nodes that come after it in its block **and** for all its subjects.

Note that by this definition every node remaining in the list is covered.

Each p -node is **responsible** for some other nodes; it has to generate a weight reduction large enough so that the weight of all nodes it is responsible for decreases by the desired factor.

An active node is responsible for all nodes that come after it in its block.

A ruler is responsible for all nodes that come after it in its block **and** for all its subjects.

Note that by this definition every node remaining in the list is covered.

Case 1: Isolated Node

Case 1: Isolated Node

Suppose we delete an isolated node v that is the i -th node in its block.

Case 1: Isolated Node

Suppose we delete an isolated node v that is the i -th node in its block.

The weight of all node that v is responsible for is

$$\sum_{i \leq j < \log n} (1 - q)^j$$

Case 1: Isolated Node

Suppose we delete an isolated node v that is the i -th node in its block.

The weight of all node that v is responsible for is

$$\sum_{i \leq j < \log n} (1 - q)^j$$

This weight reduces to

$$\sum_{i < j < \log n} (1 - q)^j$$

Case 1: Isolated Node

Suppose we delete an isolated node v that is the i -th node in its block.

The weight of all node that v is responsible for is

$$\sum_{i \leq j < \log n} (1 - q)^j$$

This weight reduces to

$$\sum_{i < j < \log n} (1 - q)^j \leq (1 - q) \sum_{i \leq j < \log n} (1 - q)^j$$

Case 1: Isolated Node

Suppose we delete an isolated node v that is the i -th node in its block.

The weight of all node that v is responsible for is

$$\sum_{i \leq j < \log n} (1 - q)^j$$

This weight reduces to

$$\sum_{i < j < \log n} (1 - q)^j \leq (1 - q) \sum_{i \leq j < \log n} (1 - q)^j$$

Hence, weight reduces by a factor $(1 - q) \leq (1 - q/4)$.

Case 2: Creating Subjects

Suppose we generate a ruler with at least one subject.

Weight of ruler: $(1 - q)^{i_1}$.

Weight of subjects: $(1 - q)^{i_j}$, $2 \leq j \leq k$.

Initial weight:

New weight:

Case 2: Creating Subjects

Suppose we generate a ruler with at least one subject.

Weight of ruler: $(1 - q)^{i_1}$.

Weight of subjects: $(1 - q)^{i_j}$, $2 \leq j \leq k$.

Initial weight:

New weight:

Case 2: Creating Subjects

Suppose we generate a ruler with at least one subject.

Weight of ruler: $(1 - q)^{i_1}$.

Weight of subjects: $(1 - q)^{i_j}$, $2 \leq j \leq k$.

Initial weight:

$$Q = \sum_{j=1}^k \sum_{i_j \leq \ell < \log n} (1 - q)^\ell \leq \frac{1}{q} \sum_{j=1}^k (1 - q)^{i_j} \leq \frac{2}{q} \sum_{j=2}^k (1 - q)^{i_j}$$

New weight:

Case 2: Creating Subjects

Suppose we generate a ruler with at least one subject.

Weight of ruler: $(1 - q)^{i_1}$.

Weight of subjects: $(1 - q)^{i_j}$, $2 \leq j \leq k$.

Initial weight:

$$Q = \sum_{j=1}^k \sum_{i_j \leq \ell < \log n} (1 - q)^\ell \leq \frac{1}{q} \sum_{j=1}^k (1 - q)^{i_j} \leq \frac{2}{q} \sum_{j=2}^k (1 - q)^{i_j}$$

New weight:

Case 2: Creating Subjects

Suppose we generate a ruler with at least one subject.

Weight of ruler: $(1 - q)^{i_1}$.

Weight of subjects: $(1 - q)^{i_j}$, $2 \leq j \leq k$.

Initial weight:

$$Q = \sum_{j=1}^k \sum_{i_j \leq \ell < \log n} (1 - q)^\ell \leq \frac{1}{q} \sum_{j=1}^k (1 - q)^{i_j} \leq \frac{2}{q} \sum_{j=2}^k (1 - q)^{i_j}$$

New weight:

Case 2: Creating Subjects

Suppose we generate a ruler with at least one subject.

Weight of ruler: $(1 - q)^{i_1}$.

Weight of subjects: $(1 - q)^{i_j}$, $2 \leq j \leq k$.

Initial weight:

$$Q = \sum_{j=1}^k \sum_{i_j \leq \ell < \log n} (1 - q)^\ell \leq \frac{1}{q} \sum_{j=1}^k (1 - q)^{i_j} \leq \frac{2}{q} \sum_{j=2}^k (1 - q)^{i_j}$$

New weight:

Case 2: Creating Subjects

Suppose we generate a ruler with at least one subject.

Weight of ruler: $(1 - q)^{i_1}$.

Weight of subjects: $(1 - q)^{i_j}$, $2 \leq j \leq k$.

Initial weight:

$$Q = \sum_{j=1}^k \sum_{i_j \leq \ell < \log n} (1 - q)^\ell \leq \frac{1}{q} \sum_{j=1}^k (1 - q)^{i_j} \leq \frac{2}{q} \sum_{j=2}^k (1 - q)^{i_j}$$

New weight:

$$Q' = Q - \frac{1}{2} \sum_{j=2}^k (1 - q)^{i_j} \leq \left(1 - \frac{q}{4}\right) Q$$

Case 2: Creating Subjects

Suppose we generate a ruler with at least one subject.

Weight of ruler: $(1 - q)^{i_1}$.

Weight of subjects: $(1 - q)^{i_j}$, $2 \leq j \leq k$.

Initial weight:

$$Q = \sum_{j=1}^k \sum_{i_j \leq \ell < \log n} (1 - q)^\ell \leq \frac{1}{q} \sum_{j=1}^k (1 - q)^{i_j} \leq \frac{2}{q} \sum_{j=2}^k (1 - q)^{i_j}$$

New weight:

$$Q' = Q - \frac{1}{2} \sum_{j=2}^k (1 - q)^{i_j} \leq \left(1 - \frac{q}{4}\right) Q$$

Case 2: Creating Subjects

Suppose we generate a ruler with at least one subject.

Weight of ruler: $(1 - q)^{i_1}$.

Weight of subjects: $(1 - q)^{i_j}$, $2 \leq j \leq k$.

Initial weight:

$$Q = \sum_{j=1}^k \sum_{i_j \leq \ell < \log n} (1 - q)^\ell \leq \frac{1}{q} \sum_{j=1}^k (1 - q)^{i_j} \leq \frac{2}{q} \sum_{j=2}^k (1 - q)^{i_j}$$

New weight:

$$Q' = Q - \frac{1}{2} \sum_{j=2}^k (1 - q)^{i_j} \leq \left(1 - \frac{q}{4}\right)Q$$

Case 3: Removing Subjects

Case 3: Removing Subjects

weight of ruler: $(1 - q)^{i_1}$; weight of subjects: $(1 - q)^{i_j}$, $2 \leq j \leq k$

Case 3: Removing Subjects

weight of ruler: $(1 - q)^{i_1}$; weight of subjects: $(1 - q)^{i_j}$, $2 \leq j \leq k$

Assume ruler removes subject with largest weight say i_2 (why?).

Initial weight:

Q

Case 3: Removing Subjects

weight of ruler: $(1 - q)^{i_1}$; weight of subjects: $(1 - q)^{i_j}$, $2 \leq j \leq k$

Assume ruler removes subject with largest weight say i_2 (why?).

Initial weight:

$$Q = \sum_{i_1 \leq \ell < \log n} (1 - q)^\ell + \frac{1}{2} \sum_{j=2}^k (1 - q)^{i_j}$$

Case 3: Removing Subjects

weight of ruler: $(1 - q)^{i_1}$; weight of subjects: $(1 - q)^{i_j}$, $2 \leq j \leq k$

Assume ruler removes subject with largest weight say i_2 (why?).

Initial weight:

$$\begin{aligned} Q &= \sum_{i_1 \leq \ell < \log n} (1 - q)^\ell + \frac{1}{2} \sum_{j=2}^k (1 - q)^{i_j} \\ &\leq \frac{1}{q} (1 - q)^{i_1} + \frac{k}{2} (1 - q)^{i_2} \end{aligned}$$

Case 3: Removing Subjects

weight of ruler: $(1 - q)^{i_1}$; weight of subjects: $(1 - q)^{i_j}$, $2 \leq j \leq k$

Assume ruler removes subject with largest weight say i_2 (why?).

Initial weight:

$$\begin{aligned} Q &= \sum_{i_1 \leq \ell < \log n} (1 - q)^\ell + \frac{1}{2} \sum_{j=2}^k (1 - q)^{i_j} \\ &\leq \frac{1}{q} (1 - q)^{i_1} + \frac{k}{2} (1 - q)^{i_2} \\ &\leq \frac{1}{q} (1 - q)^{i_2} + \frac{1}{2q} (1 - q)^{i_2} \end{aligned}$$

Case 3: Removing Subjects

weight of ruler: $(1 - q)^{i_1}$; weight of subjects: $(1 - q)^{i_j}$, $2 \leq j \leq k$

Assume ruler removes subject with largest weight say i_2 (why?).

Initial weight:

$$\begin{aligned} Q &= \sum_{i_1 \leq \ell < \log n} (1 - q)^\ell + \frac{1}{2} \sum_{j=2}^k (1 - q)^{i_j} \\ &\leq \frac{1}{q} (1 - q)^{i_1} + \frac{k}{2} (1 - q)^{i_2} \\ &\leq \frac{1}{q} (1 - q)^{i_2} + \frac{1}{2q} (1 - q)^{i_2} \end{aligned}$$

New weight:

$$Q'$$

Case 3: Removing Subjects

weight of ruler: $(1 - q)^{i_1}$; weight of subjects: $(1 - q)^{i_j}$, $2 \leq j \leq k$

Assume ruler removes subject with largest weight say i_2 (why?).

Initial weight:

$$\begin{aligned} Q &= \sum_{i_1 \leq \ell < \log n} (1 - q)^\ell + \frac{1}{2} \sum_{j=2}^k (1 - q)^{i_j} \\ &\leq \frac{1}{q} (1 - q)^{i_1} + \frac{k}{2} (1 - q)^{i_2} \\ &\leq \frac{1}{q} (1 - q)^{i_2} + \frac{1}{2q} (1 - q)^{i_2} \end{aligned}$$

New weight:

$$Q' = Q - \frac{1}{2} (1 - q)^{i_2}$$

Case 3: Removing Subjects

weight of ruler: $(1 - q)^{i_1}$; weight of subjects: $(1 - q)^{i_j}$, $2 \leq j \leq k$

Assume ruler removes subject with largest weight say i_2 (why?).

Initial weight:

$$\begin{aligned} Q &= \sum_{i_1 \leq \ell < \log n} (1 - q)^\ell + \frac{1}{2} \sum_{j=2}^k (1 - q)^{i_j} \\ &\leq \frac{1}{q} (1 - q)^{i_1} + \frac{k}{2} (1 - q)^{i_2} \\ &\leq \frac{1}{q} (1 - q)^{i_2} + \frac{1}{2q} (1 - q)^{i_2} \end{aligned}$$

New weight:

$$Q' = Q - \frac{1}{2} (1 - q)^{i_2} \leq \left(1 - \frac{q}{3}\right) Q$$

After s iterations the weight is at most

$$\frac{n}{q \log n} \left(1 - \frac{q}{4}\right)^s \stackrel{!}{\leq} \frac{n}{\log n} (1 - q)^{\log n}$$

Choosing $i = 5 \log n$ the inequality holds for sufficiently large n .

Tree Algorithms

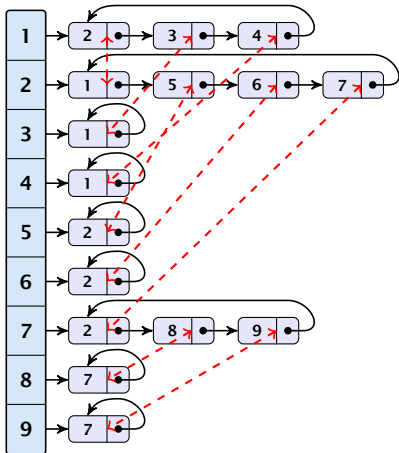
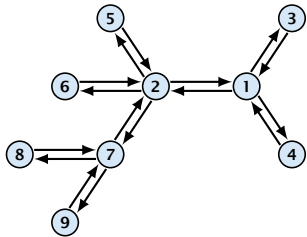

Euler Circuits

Every node v fixes an arbitrary ordering among its adjacent nodes:

$$u_0, u_1, \dots, u_{d-1}$$

We obtain an Euler tour by setting

$$\text{succ}((u_i, v)) = (v, u_{(i+1) \bmod d})$$

Lemma 11

An Euler circuit can be computed in constant time $\mathcal{O}(1)$ with $\mathcal{O}(n)$ operations.

Rooting a tree

- ▶ split the Euler tour at node r
- ▶ this gives a list on the set of directed edges (Euler path)
- ▶ assign $x[e] = 1$ for every edge;
- ▶ perform parallel prefix; let $s[\cdot]$ be the result array
- ▶ if $s[(u, v)] < s[(v, u)]$ then u is parent of v ;

Postorder Numbering

- ▶ split the Euler tour at node r
- ▶ this gives a list on the set of directed edges (Euler path)
- ▶ assign $x[e] = 1$ for every edge $(v, \text{parent}(v))$
- ▶ assign $x[e] = 0$ for every edge $(\text{parent}(v), v)$
- ▶ perform parallel prefix
- ▶ $\text{post}(v) = s[(v, \text{parent}(v))]$; $\text{post}(r) = n$

Level of nodes

- ▶ split the Euler tour at node r
- ▶ this gives a list on the set of directed edges (Euler path)
- ▶ assign $x[e] = -1$ for every edge $(v, \text{parent}(v))$
- ▶ assign $x[e] = 1$ for every edge $(\text{parent}(v), v)$
- ▶ perform parallel prefix
- ▶ $\text{level}(v) = s[(\text{parent}(v), v)]$; $\text{level}(r) = 0$

Number of descendants

- ▶ split the Euler tour at node r
- ▶ this gives a list on the set of directed edges (Euler path)
- ▶ assign $x[e] = 0$ for every edge $(\text{parent}(v), v)$
- ▶ assign $x[e] = 1$ for every edge $(v, \text{parent}(v))$, $v \neq r$
- ▶ perform parallel prefix
- ▶ $\text{size}(v) = s[(v, \text{parent}(v))] - s[(\text{parent}(v), v)]$

Rake Operation

Given a binary tree T .

Given a leaf $u \in T$ with $p(u) \neq r$ the **rake-operation** does the following

- ▶ remove u and $p(u)$
- ▶ attach sibling of u to $p(p(u))$

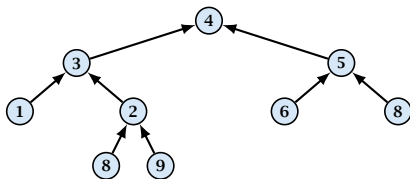

Rake Operation

Given a binary tree T .

Given a leaf $u \in T$ with $p(u) \neq r$ the **rake-operation** does the following

- ▶ remove u and $p(u)$
- ▶ attach sibling of u to $p(p(u))$

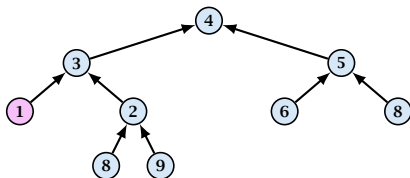

Rake Operation

Given a binary tree T .

Given a leaf $u \in T$ with $p(u) \neq r$ the **rake-operation** does the following

- ▶ remove u and $p(u)$
- ▶ attach sibling of u to $p(p(u))$

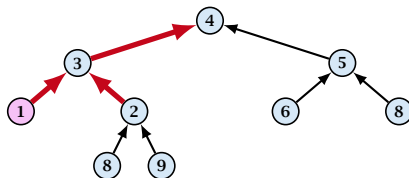

Rake Operation

Given a binary tree T .

Given a leaf $u \in T$ with $p(u) \neq r$ the **rake-operation** does the following

- ▶ remove u and $p(u)$
- ▶ attach sibling of u to $p(p(u))$

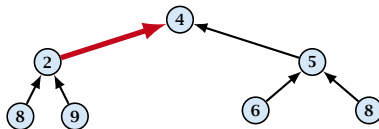

Rake Operation

Given a binary tree T .

Given a leaf $u \in T$ with $p(u) \neq r$ the **rake-operation** does the following

- ▶ remove u and $p(u)$
- ▶ attach sibling of u to $p(p(u))$

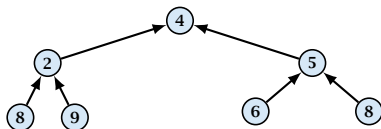

We want to apply rake operations to a binary tree T until T just consists of the root with two children.

Possible Problems:

1. We could accidentally apply the rake operation to two leaves.

2. We could accidentally apply the rake operation to two leaves x and y such that $y(x)$ and $x(y)$ are connected.

By choosing leaves carefully we ensure that none of the above cases occurs

We want to apply rake operations to a binary tree T until T just consists of the root with two children.

Possible Problems:

1. we could **concurrently** apply the rake-operation to two siblings
2. we could **concurrently** apply the rake-operation to two leaves u and v such that $p(u)$ and $p(v)$ are connected

By choosing leaves carefully we ensure that none of the above cases occurs

We want to apply rake operations to a binary tree T until T just consists of the root with two children.

Possible Problems:

1. we could **concurrently** apply the rake-operation to two siblings
2. we could **concurrently** apply the rake-operation to two leaves u and v such that $p(u)$ and $p(v)$ are connected

By choosing leaves carefully we ensure that none of the above cases occurs

We want to apply rake operations to a binary tree T until T just consists of the root with two children.

Possible Problems:

1. we could **concurrently** apply the rake-operation to two siblings
2. we could **concurrently** apply the rake-operation to two leaves u and v such that $p(u)$ and $p(v)$ are connected

By choosing leaves carefully we ensure that none of the above cases occurs

Algorithm:

- ▶ label leaves consecutively from left to right (excluding left-most and right-most leaf), and store them in an array A
- ▶ for $\lceil \log(n + 1) \rceil$ iterations
 - ▶ apply rule to all odd leaves that are left children
 - ▶ apply rule operation to remaining odd leaves (and all even leaves)
 - ▶ all nodes!
 - ▶ remove leaves

Algorithm:

- ▶ label leaves consecutively from left to right (excluding left-most and right-most leaf), and store them in an array A
- ▶ for $\lceil \log(n + 1) \rceil$ iterations
 - ▶ apply rake to all odd leaves that are left children
 - ▶ apply rake operation to remaining odd leaves (odd at start of round!!!)
 - ▶ A =even leaves

Algorithm:

- ▶ label leaves consecutively from left to right (excluding left-most and right-most leaf), and store them in an array A
- ▶ for $\lceil \log(n + 1) \rceil$ iterations
 - ▶ apply rake to all odd leaves that are left children
 - ▶ apply rake operation to remaining odd leaves (odd at start of round!!!)
 - ▶ A =even leaves

Algorithm:

- ▶ label leaves consecutively from left to right (excluding left-most and right-most leaf), and store them in an array A
- ▶ for $\lceil \log(n + 1) \rceil$ iterations
 - ▶ apply rake to all odd leaves that are left children
 - ▶ apply rake operation to remaining odd leaves (odd at start of round!!!)
 - ▶ A =even leaves

Algorithm:

- ▶ label leaves consecutively from left to right (excluding left-most and right-most leaf), and store them in an array A
- ▶ for $\lceil \log(n + 1) \rceil$ iterations
 - ▶ apply rake to all odd leaves that are left children
 - ▶ apply rake operation to remaining odd leaves (odd at start of round!!!)
 - ▶ A =even leaves

Observations

- ▶ the rake operation does not change the order of leaves
- ▶ two leaves that are siblings do not perform a rake operation in the same round because one is even and one odd at the start of the round
- ▶ two leaves that have adjacent parents either have different parity (even/odd) or they differ in the type of child (left/right)

Observations

- ▶ the rake operation does not change the order of leaves
- ▶ two leaves that are siblings do not perform a rake operation in the same round because one is even and one odd at the start of the round
- ▶ two leaves that have adjacent parents either have different parity (even/odd) or they differ in the type of child (left/right)

Observations

- ▶ the rake operation does not change the order of leaves
- ▶ two leaves that are siblings do not perform a rake operation in the same round because one is even and one odd at the start of the round
- ▶ two leaves that have adjacent parents either have different parity (even/odd) or they differ in the type of child (left/right)

Cases, when the left edge btw. $p(u)$ and $p(v)$ is a left-child edge.

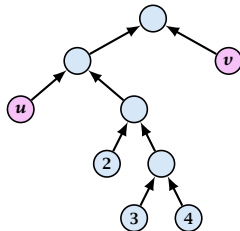
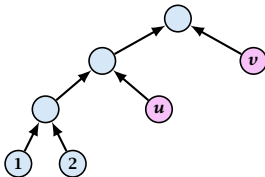

Example

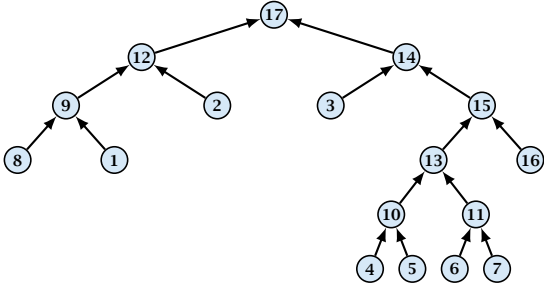

Example

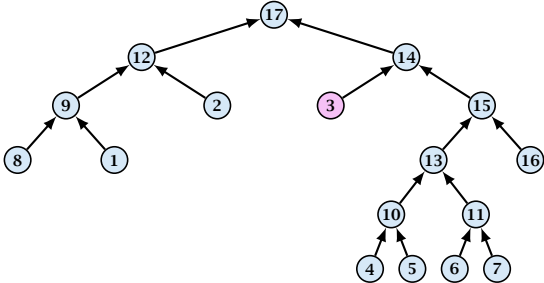

Example

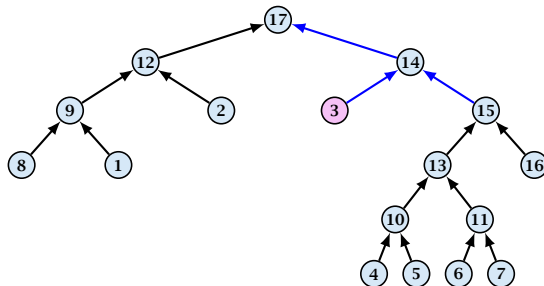

Example

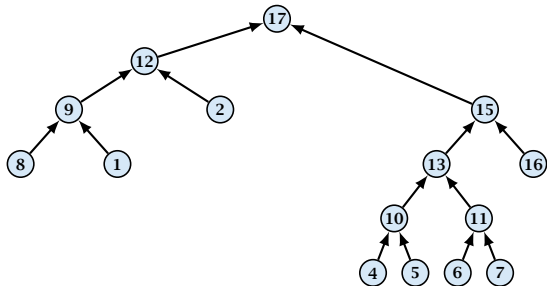

Example

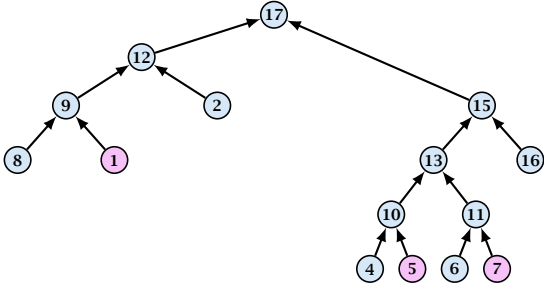

Example

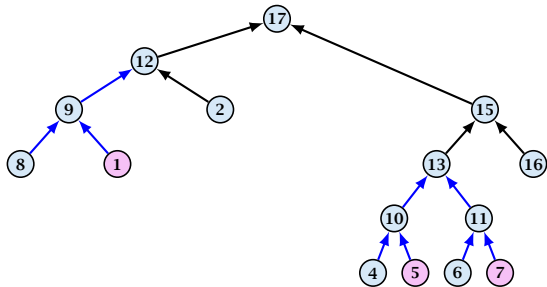

Example

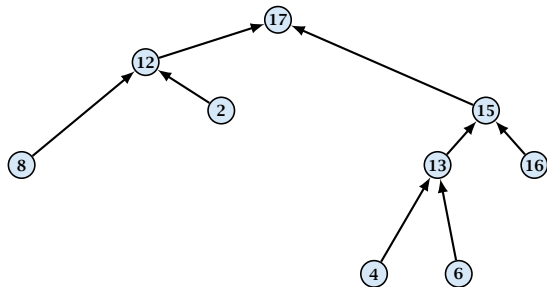

Example

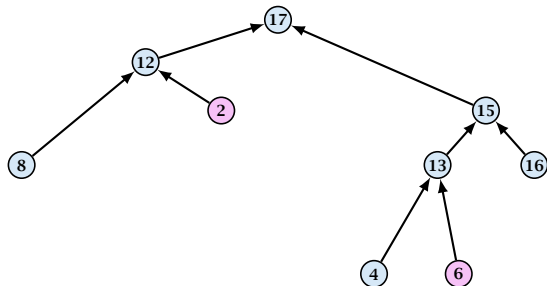

Example

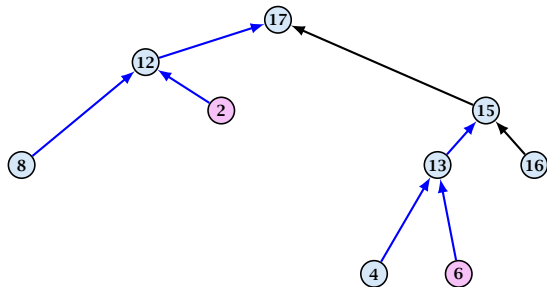

Example

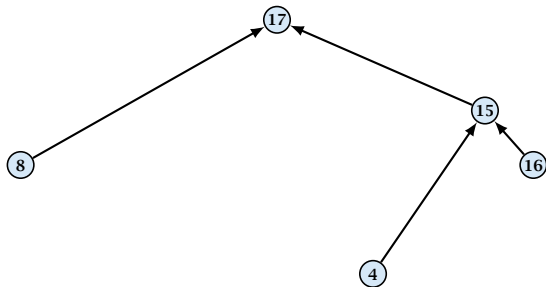

Example

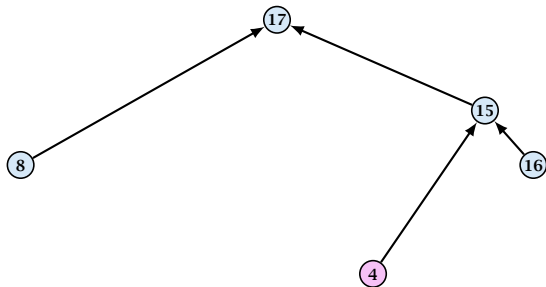

Example

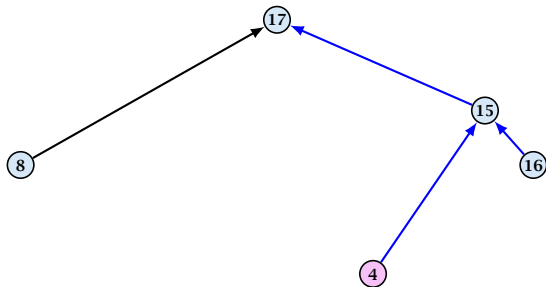

Example

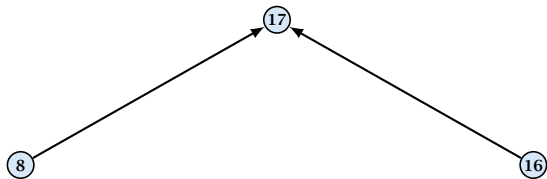

- ▶ one iteration can be performed in constant time with $\mathcal{O}(|A|)$ processors, where A is the array of leaves;
- ▶ hence, all iterations can be performed in $\mathcal{O}(\log n)$ time and $\mathcal{O}(n)$ work;
- ▶ the initial parallel prefix also requires time $\mathcal{O}(\log n)$ and work $\mathcal{O}(n)$

- ▶ one iteration can be performed in constant time with $\mathcal{O}(|A|)$ processors, where A is the array of leaves;
- ▶ hence, **all** iterations can be performed in $\mathcal{O}(\log n)$ time and $\mathcal{O}(n)$ work;
- ▶ the initial parallel prefix also requires time $\mathcal{O}(\log n)$ and work $\mathcal{O}(n)$

- ▶ one iteration can be performed in constant time with $\mathcal{O}(|A|)$ processors, where A is the array of leaves;
- ▶ hence, **all** iterations can be performed in $\mathcal{O}(\log n)$ time and $\mathcal{O}(n)$ work;
- ▶ the initial parallel prefix also requires time $\mathcal{O}(\log n)$ and work $\mathcal{O}(n)$

Evaluating Expressions

Suppose that we want to evaluate an expression tree, containing additions and multiplications.

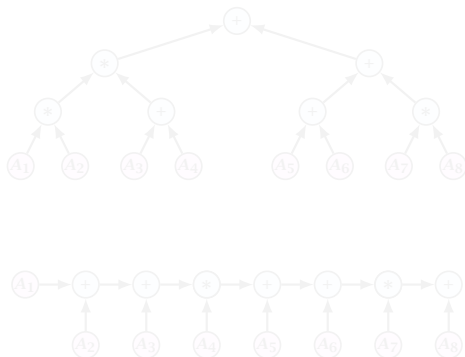

If the tree is not balanced this may be time-consuming.

Evaluating Expressions

Suppose that we want to evaluate an expression tree, containing additions and multiplications.

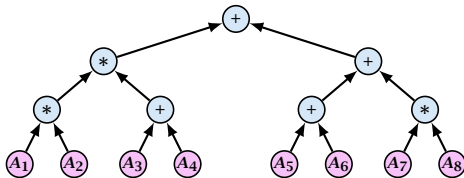

If the tree is not balanced this may be time-consuming.

Evaluating Expressions

Suppose that we want to evaluate an expression tree, containing additions and multiplications.

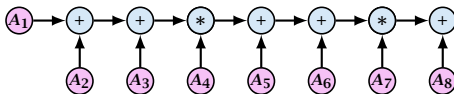
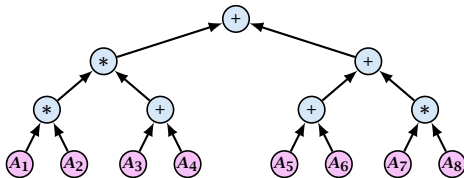

If the tree is not balanced this may be time-consuming.

We can use the rake-operation to do this quickly.

Applying the rake-operation changes the tree.

In order to maintain the value we introduce parameters a_v and b_v for every node that still allows to compute the value of a node based on the value of its children.

Invariant:

Let u be internal node with children v and w . Then

$$\text{val}(u) = (a_v \cdot \text{val}(v) + b_v) \otimes (a_w \cdot \text{val}(w) + b_w)$$

where $\otimes \in \{*, +\}$ is the operation at node u .

Initially, we can choose $a_v = 1$ and $b_v = 0$ for every node.

We can use the rake-operation to do this quickly.

Applying the rake-operation changes the tree.

In order to maintain the value we introduce parameters a_v and b_v for every node that still allows to compute the value of a node based on the value of its children.

Invariant:

Let u be internal node with children v and w . Then

$$\text{val}(u) = (a_v \cdot \text{val}(v) + b_v) \otimes (a_w \cdot \text{val}(w) + b_w)$$

where $\otimes \in \{*, +\}$ is the operation at node u .

Initially, we can choose $a_v = 1$ and $b_v = 0$ for every node.

We can use the rake-operation to do this quickly.

Applying the rake-operation changes the tree.

In order to maintain the value we introduce parameters a_v and b_v for every node that still allows to compute the value of a node based on the value of its children.

Invariant:

Let u be internal node with children v and w . Then

$$\text{val}(u) = (a_v \cdot \text{val}(v) + b_v) \otimes (a_w \cdot \text{val}(w) + b_w)$$

where $\otimes \in \{*, +\}$ is the operation at node u .

Initially, we can choose $a_v = 1$ and $b_v = 0$ for every node.

We can use the rake-operation to do this quickly.

Applying the rake-operation changes the tree.

In order to maintain the value we introduce parameters a_v and b_v for every node that still allows to compute the value of a node based on the value of its children.

Invariant:

Let u be internal node with children v and w . Then

$$\text{val}(u) = (a_v \cdot \text{val}(v) + b_v) \otimes (a_w \cdot \text{val}(w) + b_w)$$

where $\otimes \in \{*, +\}$ is the operation at node u .

Initially, we can choose $a_v = 1$ and $b_v = 0$ for every node.

We can use the rake-operation to do this quickly.

Applying the rake-operation changes the tree.

In order to maintain the value we introduce parameters a_v and b_v for every node that still allows to compute the value of a node based on the value of its children.

Invariant:

Let u be internal node with children v and w . Then

$$\text{val}(u) = (a_v \cdot \text{val}(v) + b_v) \otimes (a_w \cdot \text{val}(w) + b_w)$$

where $\otimes \in \{*, +\}$ is the operation at node u .

Initially, we can choose $a_v = 1$ and $b_v = 0$ for every node.

Rake Operation

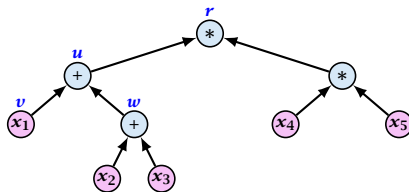

Currently the value at u is

$$\begin{aligned} \text{value}(u) &= (a_v \cdot \text{value}(v)) + b_u + (a_w \cdot \text{value}(w)) + b_u \\ &= a_v x_1 + (a_u x_1 + a_w x_2 + a_w x_3) + b_u \end{aligned}$$

In the expression for r this goes in as

$$\begin{aligned} \text{value}(r) &= (a_r \cdot \text{value}(u)) + b_r + (a_{\text{right}} \cdot \text{value}(\text{right})) + b_r \\ &= \underbrace{a_r a_v}_{a'_w} x_1 + \underbrace{a_r a_w}_{b'_w} (x_2 + x_3) + b_r \end{aligned}$$

Rake Operation

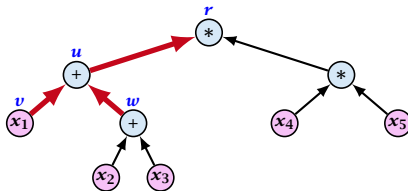

Currently the value at u is

$$\text{value}(u) = (a_v \cdot \text{value}(v) + b_v) + (a_w \cdot \text{value}(w) + b_w) \\ = a_u \cdot (x_1 + a_w \cdot \text{value}(w) + b_w) + b_u$$

In the expression for r this goes in as

$$\text{value}(r) = (a_r \cdot \text{value}(u) + b_r) \cdot (x_4 + x_5) \\ = \underbrace{a_r a_u}_{a'_w} \cdot (x_1 + a_w \cdot \text{value}(w) + b_w) + \underbrace{a_r b_u}_{b'_w} \cdot (x_4 + x_5) + b_r$$

Rake Operation

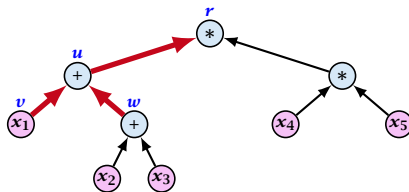

Currently the value at u is

$$v + w = x_1 + (x_2 + x_3)$$

In the expression for r this goes in as

$$(x_1 + x_2 + x_3) * (x_4 + x_5)$$

$\underbrace{\hspace{10em}}_{a'_w} \quad \underbrace{\hspace{10em}}_{b'_w}$

Rake Operation

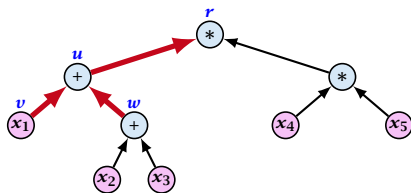

Currently the value at u is

$$\begin{aligned}\text{val}(u) &= (a_v \cdot \text{val}(v) + b_v) + (a_w \cdot \text{val}(w) + b_w) \\ &= x_1 + (a_w \cdot \text{val}(w) + b_w)\end{aligned}$$

In the expression for r this goes in as

$$\begin{aligned}\text{val}(r) &= (a_u \cdot \text{val}(u) + b_u) + (a_{x_4} \cdot \text{val}(x_4) + b_{x_4}) + (a_{x_5} \cdot \text{val}(x_5) + b_{x_5}) \\ &= \underbrace{a_u}_{a'_w} \cdot \text{val}(w) + \underbrace{a_u \cdot x_1 + a_u b_u + b_u}_{b'_w} + (a_{x_4} \cdot \text{val}(x_4) + b_{x_4}) + (a_{x_5} \cdot \text{val}(x_5) + b_{x_5})\end{aligned}$$

Rake Operation

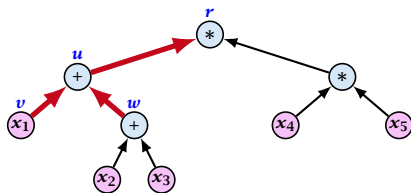

Currently the value at u is

$$\begin{aligned}\text{val}(u) &= (a_v \cdot \text{val}(v) + b_v) + (a_w \cdot \text{val}(w) + b_w) \\ &= x_1 + (a_w \cdot \text{val}(w) + b_w)\end{aligned}$$

In the expression for r this goes in as

$$\underbrace{\text{val}(u)}_{a'_w} \cdot \text{val}(\text{right child of } r) + b'_w$$

Rake Operation

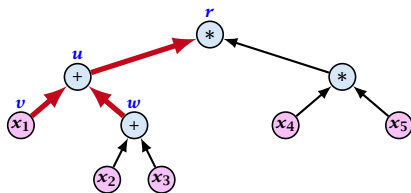

Currently the value at u is

$$\begin{aligned}\text{val}(u) &= (a_v \cdot \text{val}(v) + b_v) + (a_w \cdot \text{val}(w) + b_w) \\ &= x_1 + (a_w \cdot \text{val}(w) + b_w)\end{aligned}$$

In the expression for r this goes in as



Rake Operation

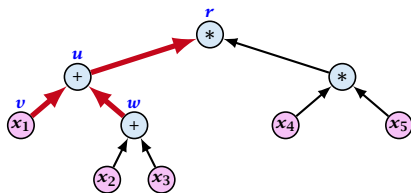

Currently the value at u is

$$\begin{aligned}\text{val}(u) &= (a_v \cdot \text{val}(v) + b_v) + (a_w \cdot \text{val}(w) + b_w) \\ &= x_1 + (a_w \cdot \text{val}(w) + b_w)\end{aligned}$$

In the expression for r this goes in as

$$\begin{aligned}a_u \cdot [x_1 + (a_w \cdot \text{val}(w) + b_w)] + b_u \\ = \underbrace{a_u a_w}_{a'_w} \cdot \text{val}(w) + \underbrace{a_u x_1 + a_u b_w + b_u}_{b'_w}\end{aligned}$$

Rake Operation

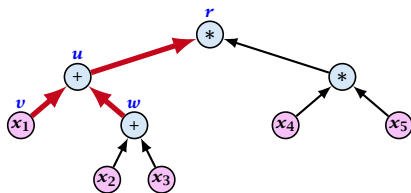

Currently the value at u is

$$\begin{aligned}\text{val}(u) &= (a_v \cdot \text{val}(v) + b_v) + (a_w \cdot \text{val}(w) + b_w) \\ &= x_1 + (a_w \cdot \text{val}(w) + b_w)\end{aligned}$$

In the expression for r this goes in as

$$\begin{aligned}a_u \cdot [x_1 + (a_w \cdot \text{val}(w) + b_w)] + b_u \\ = \underbrace{a_u a_w}_{a'_w} \cdot \text{val}(w) + \underbrace{a_u x_1 + a_u b_w + b_u}_{b'_w}\end{aligned}$$

Rake Operation

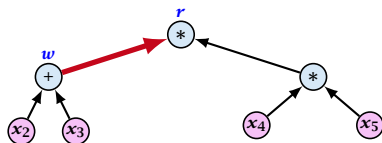

Currently the value at u is

$$\begin{aligned}\text{val}(u) &= (a_v \cdot \text{val}(v) + b_v) + (a_w \cdot \text{val}(w) + b_w) \\ &= x_1 + (a_w \cdot \text{val}(w) + b_w)\end{aligned}$$

In the expression for r this goes in as

$$\begin{aligned}a_u \cdot [x_1 + (a_w \cdot \text{val}(w) + b_w)] + b_u \\ = \underbrace{a_u a_w}_{a'_w} \cdot \text{val}(w) + \underbrace{a_u x_1 + a_u b_w + b_u}_{b'_w}\end{aligned}$$

Rake Operation

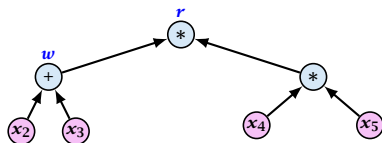

Currently the value at u is

$$\begin{aligned}\text{val}(u) &= (a_v \cdot \text{val}(v) + b_v) + (a_w \cdot \text{val}(w) + b_w) \\ &= x_1 + (a_w \cdot \text{val}(w) + b_w)\end{aligned}$$

In the expression for r this goes in as

$$\begin{aligned}a_u \cdot [x_1 + (a_w \cdot \text{val}(w) + b_w)] + b_u \\ = \underbrace{a_u a_w}_{a'_w} \cdot \text{val}(w) + \underbrace{a_u x_1 + a_u b_w + b_u}_{b'_w}\end{aligned}$$

If we change the a and b -values during a rake-operation according to the previous slide we can calculate the value of the root in the end.

Lemma 12

We can evaluate an arithmetic expression tree in time $\mathcal{O}(\log n)$ and work $\mathcal{O}(n)$ regardless of the height or depth of the tree.

By performing the rake-operation in the reverse order we can also compute the value at each node in the tree.

If we change the a and b -values during a rake-operation according to the previous slide we can calculate the value of the root in the end.

Lemma 12

We can evaluate an arithmetic expression tree in time $\mathcal{O}(\log n)$ and work $\mathcal{O}(n)$ regardless of the height or depth of the tree.

By performing the rake-operation in the reverse order we can also compute the value at each node in the tree.

If we change the a and b -values during a rake-operation according to the previous slide we can calculate the value of the root in the end.

Lemma 12

We can evaluate an arithmetic expression tree in time $\mathcal{O}(\log n)$ and work $\mathcal{O}(n)$ regardless of the height or depth of the tree.

By performing the rake-operation in the reverse order we can also compute the value at each node in the tree.

Lemma 13

We compute *tree functions* for arbitrary trees in time $\mathcal{O}(\log n)$ and a linear number of operations.

proof on board...

In the **LCA (least common ancestor) problem** we are given a tree and the goal is to design a data-structure that answers LCA-queries in constant time.

Least Common Ancestor

LCAs on complete binary trees (inorder numbering):

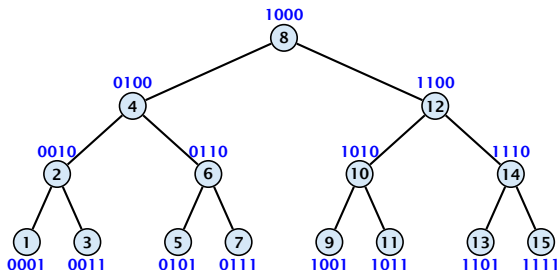

The least common ancestor of u and v is

$$z_1 z_2 \dots z_i 1 0 \dots 0$$

where z_{i+1} is the first bit-position in which u and v differ.

Least Common Ancestor

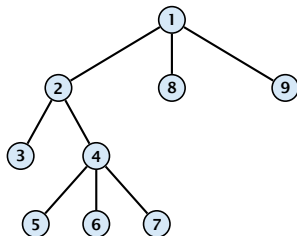

nodes

1	2	3	2	4	5	4	6	4	7	4	2	1	8	1	9	1
---	---	---	---	---	---	---	---	---	---	---	---	---	---	---	---	---

levels

0	1	2	1	2	3	2	3	2	3	2	1	0	1	0	1	0
---	---	---	---	---	---	---	---	---	---	---	---	---	---	---	---	---

$\ell(v)$ is index of first appearance of v in node-sequence.

$r(v)$ is index of last appearance of v in node-sequence.

$\ell(v)$ and $r(v)$ can be computed in constant time, given the node- and level-sequence.

Least Common Ancestor

Lemma 14

1. *u is ancestor of v iff $\ell(u) < \ell(v) < r(u)$*
2. *u and v are not related iff either $r(u) < \ell(v)$ or $r(v) < \ell(u)$*
3. *suppose $r(u) < \ell(v)$ then $\text{LCA}(u, v)$ is vertex with minimum level over interval $[r(u), \ell(v)]$.*

Range Minima Problem

Given an array $A[1 \dots n]$, a **range minimum query** (ℓ, r) consists of a left index $\ell \in \{1, \dots, n\}$ and a right index $r \in \{1, \dots, n\}$.

The answer has to return the index of the minimum element in the subsequence $A[\ell \dots r]$.

The goal in the **range minima problem** is to preprocess the array such that range minima queries can be answered quickly (constant time).

Range Minima Problem

Given an array $A[1 \dots n]$, a **range minimum query** (ℓ, r) consists of a left index $\ell \in \{1, \dots, n\}$ and a right index $r \in \{1, \dots, n\}$.

The answer has to return the index of the minimum element in the subsequence $A[\ell \dots r]$.

The goal in the **range minima problem** is to preprocess the array such that range minima queries can be answered quickly (constant time).

Range Minima Problem

Given an array $A[1 \dots n]$, a **range minimum query** (ℓ, r) consists of a left index $\ell \in \{1, \dots, n\}$ and a right index $r \in \{1, \dots, n\}$.

The answer has to return the index of the minimum element in the subsequence $A[\ell \dots r]$.

The goal in the **range minima problem** is to preprocess the array such that range minima queries can be answered quickly (constant time).

Range Minima Problem

Given an array $A[1 \dots n]$, a **range minimum query** (ℓ, r) consists of a left index $\ell \in \{1, \dots, n\}$ and a right index $r \in \{1, \dots, n\}$.

The answer has to return the index of the minimum element in the subsequence $A[\ell \dots r]$.

The goal in the **range minima problem** is to preprocess the array such that range minima queries can be answered quickly (constant time).

Observation

Given an algorithm for solving the range minima problem in time $T(n)$ and work $W(n)$ we can obtain an algorithm that solves the LCA-problem in time $\mathcal{O}(T(n) + \log n)$ and work $\mathcal{O}(n + W(n))$.

Remark

In the sequential setting the LCA-problem and the range minima problem are equivalent. This is not necessarily true in the parallel setting.

For solving the LCA-problem it is sufficient to solve the **restricted range minima problem** where two successive elements in the array just differ by $+1$ or -1 .

Observation

Given an algorithm for solving the range minima problem in time $T(n)$ and work $W(n)$ we can obtain an algorithm that solves the LCA-problem in time $\mathcal{O}(T(n) + \log n)$ and work $\mathcal{O}(n + W(n))$.

Remark

In the sequential setting the LCA-problem and the range minima problem are equivalent. This is not necessarily true in the parallel setting.

For solving the LCA-problem it is sufficient to solve the **restricted range minima problem** where two successive elements in the array just differ by $+1$ or -1 .

Observation

Given an algorithm for solving the range minima problem in time $T(n)$ and work $W(n)$ we can obtain an algorithm that solves the LCA-problem in time $\mathcal{O}(T(n) + \log n)$ and work $\mathcal{O}(n + W(n))$.

Remark

In the sequential setting the LCA-problem and the range minima problem are equivalent. This is not necessarily true in the parallel setting.

For solving the LCA-problem it is sufficient to solve the **restricted range minima problem** where two successive elements in the array just differ by $+1$ or -1 .

Observation

Given an algorithm for solving the range minima problem in time $T(n)$ and work $W(n)$ we can obtain an algorithm that solves the LCA-problem in time $\mathcal{O}(T(n) + \log n)$ and work $\mathcal{O}(n + W(n))$.

Remark

In the sequential setting the LCA-problem and the range minima problem are equivalent. This is not necessarily true in the parallel setting.

For solving the LCA-problem it is sufficient to solve the **restricted range minima problem** where two successive elements in the array just differ by $+1$ or -1 .

Prefix and Suffix Minima

Tree with prefix-minima and suffix-minima:

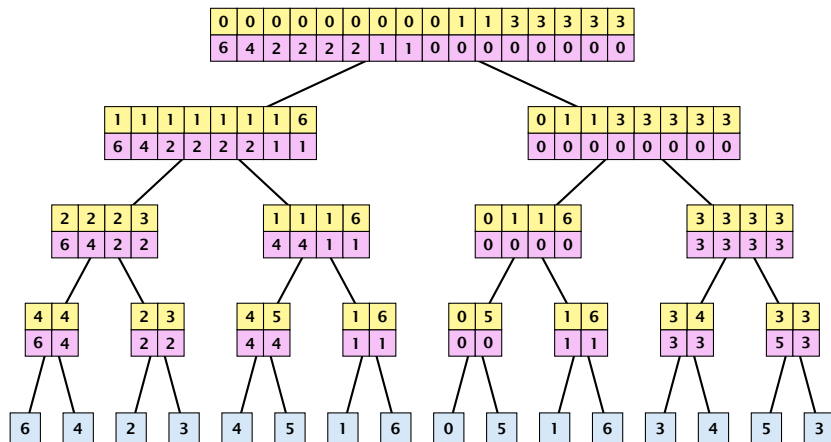

- ▶ Suppose we have an array A of length $n = 2^k$
- ▶ We compute a complete binary tree T with n leaves.
- ▶ Each internal node corresponds to a subsequence of A . It contains an array with the prefix and suffix minima of this subsequence.

Given the tree T we can answer a range minimum query (ℓ, r) in constant time.

we can determine the LCA z of ℓ and r in constant time.

Since T is a complete binary tree

we consider the suffix minimum of ℓ in the left child of z and the prefix minimum of r in the right child of z .

The minimum of these two values is the result.

- ▶ Suppose we have an array A of length $n = 2^k$
- ▶ We compute a complete binary tree T with n leaves.
- ▶ Each internal node corresponds to a subsequence of A . It contains an array with the prefix and suffix minima of this subsequence.

Given the tree T we can answer a range minimum query (ℓ, r) in constant time.

we can determine the LCA x of ℓ and r in constant time.

Since T is a complete binary tree

we can consider the suffix minimum of ℓ in the left child of x

and the prefix minimum of r in the right child of x .

The minimum of these two values is the result.

- ▶ Suppose we have an array A of length $n = 2^k$
- ▶ We compute a complete binary tree T with n leaves.
- ▶ Each internal node corresponds to a subsequence of A . It contains an array with the prefix and suffix minima of this subsequence.

Given the tree T we can answer a range minimum query (ℓ, r) in constant time.

we can compute the LCA of ℓ and r in constant time.

we can compute the LCA of ℓ and r in constant time.

we can compute the LCA of ℓ and r in constant time.

we can compute the LCA of ℓ and r in constant time.

we can compute the LCA of ℓ and r in constant time.

we can compute the LCA of ℓ and r in constant time.

we can compute the LCA of ℓ and r in constant time.

we can compute the LCA of ℓ and r in constant time.

we can compute the LCA of ℓ and r in constant time.

- ▶ Suppose we have an array A of length $n = 2^k$
- ▶ We compute a complete binary tree T with n leaves.
- ▶ Each internal node corresponds to a subsequence of A . It contains an array with the prefix and suffix minima of this subsequence.

Given the tree T we can answer a range minimum query (ℓ, r) in constant time.

- ▶ we can determine the LCA x of ℓ and r in constant time since T is a complete binary tree
- ▶ Then we consider the suffix minimum of ℓ in the left child of x and the prefix minimum of r in the right child of x .
- ▶ The minimum of these two values is the result.

- ▶ Suppose we have an array A of length $n = 2^k$
- ▶ We compute a complete binary tree T with n leaves.
- ▶ Each internal node corresponds to a subsequence of A . It contains an array with the prefix and suffix minima of this subsequence.

Given the tree T we can answer a range minimum query (ℓ, r) in constant time.

- ▶ we can determine the LCA x of ℓ and r in constant time since T is a complete binary tree
- ▶ Then we consider the suffix minimum of ℓ in the left child of x and the prefix minimum of r in the right child of x .
- ▶ The minimum of these two values is the result.

- ▶ Suppose we have an array A of length $n = 2^k$
- ▶ We compute a complete binary tree T with n leaves.
- ▶ Each internal node corresponds to a subsequence of A . It contains an array with the prefix and suffix minima of this subsequence.

Given the tree T we can answer a range minimum query (ℓ, r) in constant time.

- ▶ we can determine the LCA x of ℓ and r in constant time since T is a complete binary tree
- ▶ Then we consider the suffix minimum of ℓ in the left child of x and the prefix minimum of r in the right child of x .
- ▶ The minimum of these two values is the result.

Lemma 15

We can solve the range minima problem in time $\mathcal{O}(\log n)$ and work $\mathcal{O}(n \log n)$.

Reducing the Work

Partition A into blocks B_i of length $\log n$

Preprocess each B_i block separately by a sequential algorithm so that range-minima queries within the block can be answered in constant time. (how?)

For each block B_i compute the minimum x_i and its prefix and suffix minima.

Use the previous algorithm on the array $(x_1, \dots, x_{n/\log n})$.

Reducing the Work

Partition A into blocks B_i of length $\log n$

Preprocess each B_i block separately by a sequential algorithm so that range-minima queries within the block can be answered in constant time. (**how?**)

For each block B_i compute the minimum x_i and its prefix and suffix minima.

Use the previous algorithm on the array $(x_1, \dots, x_{n/\log n})$.

Reducing the Work

Partition A into blocks B_i of length $\log n$

Preprocess each B_i block separately by a sequential algorithm so that range-minima queries within the block can be answered in constant time. (**how?**)

For each block B_i compute the minimum x_i and its prefix and suffix minima.

Use the previous algorithm on the array $(x_1, \dots, x_{n/\log n})$.

Reducing the Work

Partition A into blocks B_i of length $\log n$

Preprocess each B_i block separately by a sequential algorithm so that range-minima queries within the block can be answered in constant time. (**how?**)

For each block B_i compute the minimum x_i and its prefix and suffix minima.

Use the previous algorithm on the array $(x_1, \dots, x_{n/\log n})$.

Answering a query (ℓ, r) :

- ▶ if ℓ and r are from the same block the data-structure for this block gives us the result in constant time
- ▶ if ℓ and r are from different blocks the result is a minimum of three elements:
 - the suffix minimum of entry ℓ in ℓ 's block
 - the minimum among $x_{\ell+1}, \dots, x_{r-1}$
 - the prefix minimum of entry r in r 's block

Answering a query (ℓ, r) :

- ▶ if ℓ and r are from the same block the data-structure for this block gives us the result in constant time
- ▶ if ℓ and r are from different blocks the result is a minimum of three elements:
 - the suffix minimum of entry ℓ in ℓ 's block
 - the minimum among $x_{\ell+1}, \dots, x_{r-1}$
 - the prefix minimum of entry r in r 's block

Searching

An extension of binary search with p processors gives that one can find the rank of an element in

$$\log_{p+1}(n) = \frac{\log n}{\log(p+1)}$$

many parallel steps with p processors. (not work-optimal)

This requires a CREW PRAM model. For the EREW model searching cannot be done faster than $\mathcal{O}(\log n - \log p)$ with p processors even if there are p copies of the search key.

Searching

An extension of binary search with p processors gives that one can find the rank of an element in

$$\log_{p+1}(n) = \frac{\log n}{\log(p+1)}$$

many parallel steps with p processors. (**not work-optimal**)

This requires a CREW PRAM model. For the EREW model searching cannot be done faster than $\mathcal{O}(\log n - \log p)$ with p processors even if there are p copies of the search key.

Searching

An extension of binary search with p processors gives that one can find the rank of an element in

$$\log_{p+1}(n) = \frac{\log n}{\log(p+1)}$$

many parallel steps with p processors. (**not work-optimal**)

This requires a CREW PRAM model. For the EREW model searching cannot be done faster than $\mathcal{O}(\log n - \log p)$ with p processors even if there are p copies of the search key.

Merging

Given two sorted sequences $A = (a_1, \dots, a_n)$ and $B = (b_1, \dots, b_n)$, compute the sorted sequence $C = (c_1, \dots, c_n)$.

Definition 16

Let $X = (x_1, \dots, x_t)$ be a sequence. The **rank** $\text{rank}(y : X)$ of y in X is

$$\text{rank}(y : X) = |\{x \in X \mid x \leq y\}|$$

For a sequence $Y = (y_1, \dots, y_s)$ we define $\text{rank}(Y : X) := (r_1, \dots, r_s)$ with $r_i = \text{rank}(y_i : X)$.

Merging

Given two sorted sequences $A = (a_1, \dots, a_n)$ and $B = (b_1, \dots, b_n)$, compute the sorted sequence $C = (c_1, \dots, c_n)$.

Definition 16

Let $X = (x_1, \dots, x_t)$ be a sequence. The **rank** $\text{rank}(y : X)$ of y in X is

$$\text{rank}(y : X) = |\{x \in X \mid x \leq y\}|$$

For a sequence $Y = (y_1, \dots, y_s)$ we define $\text{rank}(Y : X) := (r_1, \dots, r_s)$ with $r_i = \text{rank}(y_i : X)$.

Merging

Given two sorted sequences $A = (a_1, \dots, a_n)$ and $B = (b_1, \dots, b_n)$, compute the sorted sequence $C = (c_1, \dots, c_n)$.

Definition 16

Let $X = (x_1, \dots, x_t)$ be a sequence. The **rank** $\text{rank}(y : X)$ of y in X is

$$\text{rank}(y : X) = |\{x \in X \mid x \leq y\}|$$

For a sequence $Y = (y_1, \dots, y_s)$ we define $\text{rank}(Y : X) := (r_1, \dots, r_s)$ with $r_i = \text{rank}(y_i : X)$.

Merging

Given two sorted sequences $A = (a_1, \dots, a_n)$ and $B = (b_1, \dots, b_n)$, compute the sorted sequence $C = (c_1, \dots, c_n)$.

Definition 16

Let $X = (x_1, \dots, x_t)$ be a sequence. The **rank** $\text{rank}(y : X)$ of y in X is

$$\text{rank}(y : X) = |\{x \in X \mid x \leq y\}|$$

For a sequence $Y = (y_1, \dots, y_s)$ we define $\text{rank}(Y : X) := (r_1, \dots, r_s)$ with $r_i = \text{rank}(y_i : X)$.

Merging

We have already seen a merging-algorithm that runs in time $\mathcal{O}(\log n)$ and work $\mathcal{O}(n)$.

Using the fast search algorithm we can improve this to a running time of $\mathcal{O}(\log \log n)$ and work $\mathcal{O}(n \log \log n)$.

Merging

We have already seen a merging-algorithm that runs in time $\mathcal{O}(\log n)$ and work $\mathcal{O}(n)$.

Using the fast search algorithm we can improve this to a running time of $\mathcal{O}(\log \log n)$ and work $\mathcal{O}(n \log \log n)$.

Merging

Input: $A = a_1, \dots, a_n$; $B = b_1, \dots, b_m$; $m \leq n$

1. if $m < 4$ then rank elements of B , using the parallel search algorithm with p processors. Time: $\mathcal{O}(1)$. Work: $\mathcal{O}(n)$.
2. Concurrently rank elements $b_{\sqrt{m}}, b_{2\sqrt{m}}, \dots, b_m$ in A using the parallel search algorithm with $p = \sqrt{n}$. Time: $\mathcal{O}(1)$.
Work: $\mathcal{O}(\sqrt{m} \cdot \sqrt{n}) = \mathcal{O}(n)$

$$j(i) := \text{rank}(b_{i\sqrt{m}} : A)$$

3. Let $B_i = (b_{i\sqrt{m}+1}, \dots, b_{(i+1)\sqrt{m}-1})$; and
 $A_i = (a_{j(i)+1}, \dots, a_{j(i+1)})$.

Recursively compute $\text{rank}(B_i : A_i)$.

4. Let k be index not a multiple of \sqrt{m} . $i = \lceil \frac{k}{\sqrt{m}} \rceil$. Then
 $\text{rank}(b_k : A) = j(i) + \text{rank}(b_k : A_i)$.

Merging

Input: $A = a_1, \dots, a_n$; $B = b_1, \dots, b_m$; $m \leq n$

1. if $m < 4$ then rank elements of B , using the parallel search algorithm with p processors. Time: $\mathcal{O}(1)$. Work: $\mathcal{O}(n)$.
2. Concurrently rank elements $b_{\sqrt{m}}, b_{2\sqrt{m}}, \dots, b_m$ in A using the parallel search algorithm with $p = \sqrt{n}$. Time: $\mathcal{O}(1)$.
Work: $\mathcal{O}(\sqrt{m} \cdot \sqrt{n}) = \mathcal{O}(n)$

$$j(i) := \text{rank}(b_{i\sqrt{m}} : A)$$

3. Let $B_i = (b_{i\sqrt{m}+1}, \dots, b_{(i+1)\sqrt{m}-1})$; and
 $A_i = (a_{j(i)+1}, \dots, a_{j(i+1)})$.

Recursively compute $\text{rank}(B_i : A_i)$.

4. Let k be index not a multiple of \sqrt{m} . $i = \lceil \frac{k}{\sqrt{m}} \rceil$. Then
 $\text{rank}(b_k : A) = j(i) + \text{rank}(b_k : A_i)$.

Merging

Input: $A = a_1, \dots, a_n$; $B = b_1, \dots, b_m$; $m \leq n$

1. if $m < 4$ then rank elements of B , using the parallel search algorithm with p processors. Time: $\mathcal{O}(1)$. Work: $\mathcal{O}(n)$.
2. Concurrently rank elements $b_{\sqrt{m}}, b_{2\sqrt{m}}, \dots, b_m$ in A using the parallel search algorithm with $p = \sqrt{n}$. Time: $\mathcal{O}(1)$.
Work: $\mathcal{O}(\sqrt{m} \cdot \sqrt{n}) = \mathcal{O}(n)$

$$j(i) := \text{rank}(b_{i\sqrt{m}} : A)$$

3. Let $B_i = (b_{i\sqrt{m}+1}, \dots, b_{(i+1)\sqrt{m}-1})$; and
 $A_i = (a_{j(i)+1}, \dots, a_{j(i+1)})$.

Recursively compute $\text{rank}(B_i : A_i)$.

4. Let k be index not a multiple of \sqrt{m} . $i = \lceil \frac{k}{\sqrt{m}} \rceil$. Then
 $\text{rank}(b_k : A) = j(i) + \text{rank}(b_k : A_i)$.

Merging

Input: $A = a_1, \dots, a_n$; $B = b_1, \dots, b_m$; $m \leq n$

1. if $m < 4$ then rank elements of B , using the parallel search algorithm with p processors. Time: $\mathcal{O}(1)$. Work: $\mathcal{O}(n)$.
2. Concurrently rank elements $b_{\sqrt{m}}, b_{2\sqrt{m}}, \dots, b_m$ in A using the parallel search algorithm with $p = \sqrt{n}$. Time: $\mathcal{O}(1)$.
Work: $\mathcal{O}(\sqrt{m} \cdot \sqrt{n}) = \mathcal{O}(n)$

$$j(i) := \text{rank}(b_{i\sqrt{m}} : A)$$

3. Let $B_i = (b_{i\sqrt{m}+1}, \dots, b_{(i+1)\sqrt{m}-1})$; and
 $A_i = (a_{j(i)+1}, \dots, a_{j(i+1)})$.

Recursively compute $\text{rank}(B_i : A_i)$.

4. Let k be index not a multiple of \sqrt{m} . $i = \lceil \frac{k}{\sqrt{m}} \rceil$. Then
 $\text{rank}(b_k : A) = j(i) + \text{rank}(b_k : A_i)$.

The algorithm can be made work-optimal by standard techniques.

proof on board...

Lemma 17

A straightforward parallelization of Mergesort can be implemented in time $\mathcal{O}(\log n \log \log n)$ and with work $\mathcal{O}(n \log n)$.

This assumes the CREW-PRAM model.

Lemma 17

A straightforward parallelization of Mergesort can be implemented in time $\mathcal{O}(\log n \log \log n)$ and with work $\mathcal{O}(n \log n)$.

This assumes the CREW-PRAM model.

Mergesort

Let $L[v]$ denote the (sorted) sublist of elements stored at the leaf nodes rooted at v .

We can view Mergesort as computing $L[v]$ for a complete binary tree where the leaf nodes correspond to nodes in the given array.

Since the merge-operations on one level of the complete binary tree can be performed in parallel we obtain time $\mathcal{O}(h \log \log n)$ and work $\mathcal{O}(hn)$, where $h = \mathcal{O}(\log n)$ is the height of the tree.

Mergesort

Let $L[v]$ denote the (sorted) sublist of elements stored at the leaf nodes rooted at v .

We can view Mergesort as computing $L[v]$ for a complete binary tree where the leaf nodes correspond to nodes in the given array.

Since the merge-operations on one level of the complete binary tree can be performed in parallel we obtain time $\mathcal{O}(h \log \log n)$ and work $\mathcal{O}(hn)$, where $h = \mathcal{O}(\log n)$ is the height of the tree.

Mergesort

Let $L[v]$ denote the (sorted) sublist of elements stored at the leaf nodes rooted at v .

We can view Mergesort as computing $L[v]$ for a complete binary tree where the leaf nodes correspond to nodes in the given array.

Since the merge-operations on one level of the complete binary tree can be performed in parallel we obtain time $\mathcal{O}(h \log \log n)$ and work $\mathcal{O}(hn)$, where $h = \mathcal{O}(\log n)$ is the height of the tree.

Pipelined Mergesort

We again compute $L[v]$ for every node in the complete binary tree.

After round s , $L_s[v]$ is an **approximation** of $L[v]$ that will be improved in future rounds.

For $s \geq 3 \text{ height}(v)$, $L_s[v] = L[v]$.

Pipelined Mergesort

We again compute $L[v]$ for every node in the complete binary tree.

After round s , $L_s[v]$ is an **approximation** of $L[v]$ that will be improved in future rounds.

For $s \geq 3 \text{ height}(v)$, $L_s[v] = L[v]$.

Pipelined Mergesort

We again compute $L[v]$ for every node in the complete binary tree.

After round s , $L_s[v]$ is an **approximation** of $L[v]$ that will be improved in future rounds.

For $s \geq 3 \text{ height}(v)$, $L_s[v] = L[v]$.

Pipelined Mergesort

In every round, a node v sends $\text{sample}(L_s[v])$ (an approximation of its current list) upwards, and receives approximations of the lists of its children.

It then computes a new approximation of its list.

A node is called **active** in round s if $s \leq 3 \text{ height}(v)$ (this means its list is not yet complete at the start of the round, i.e., $L_{s-1}[v] \neq L[v]$).

Pipelined Mergesort

In every round, a node v sends $\text{sample}(L_s[v])$ (an approximation of its current list) upwards, and receives approximations of the lists of its children.

It then computes a new approximation of its list.

A node is called **active** in round s if $s \leq 3 \text{ height}(v)$ (this means its list is not yet complete at the start of the round, i.e., $L_{s-1}[v] \neq L[v]$).

Pipelined Mergesort

In every round, a node v sends $\text{sample}(L_s[v])$ (an approximation of its current list) upwards, and receives approximations of the lists of its children.

It then computes a new approximation of its list.

A node is called **active** in round s if $s \leq 3 \text{height}(v)$ (this means its list is not yet complete at the start of the round, i.e., $L_{s-1}[v] \neq L[v]$).

Pipelined Mergesort

Algorithm 11 ColeSort()

```
1: initialize  $L_0[v] = A_v$  for leaf nodes;  $L_0[v] = \emptyset$  otw.  
2: for  $s \leftarrow 1$  to  $3 \cdot \text{height}(T)$  do  
3:   for all active nodes  $v$  do  
4:     //  $u$  and  $w$  children of  $v$   
5:      $L'_s[u] \leftarrow \text{sample}(L_{s-1}[u])$   
6:      $L'_s[w] \leftarrow \text{sample}(L_{s-1}[w])$   
7:      $L_s[v] \leftarrow \text{merge}(L'_s[u], L'_s[w])$ 
```

$$\text{sample}(L_s[v]) = \begin{cases} \text{sample}_4(L_s[v]) & s \leq 3 \text{ height}(v) \\ \text{sample}_2(L_s[v]) & s = 3 \text{ height}(v) + 1 \\ \text{sample}_1(L_s[v]) & s = 3 \text{ height}(v) + 2 \end{cases}$$

Pipelined Mergesort

Algorithm 11 ColeSort()

```
1: initialize  $L_0[v] = A_v$  for leaf nodes;  $L_0[v] = \emptyset$  otw.  
2: for  $s \leftarrow 1$  to  $3 \cdot \text{height}(T)$  do  
3:   for all active nodes  $v$  do  
4:     //  $u$  and  $w$  children of  $v$   
5:      $L'_s[u] \leftarrow \text{sample}(L_{s-1}[u])$   
6:      $L'_s[w] \leftarrow \text{sample}(L_{s-1}[w])$   
7:      $L_s[v] \leftarrow \text{merge}(L'_s[u], L'_s[w])$ 
```

$$\text{sample}(L_s[v]) = \begin{cases} \text{sample}_4(L_s[v]) & s \leq 3 \text{ height}(v) \\ \text{sample}_2(L_s[v]) & s = 3 \text{ height}(v) + 1 \\ \text{sample}_1(L_s[v]) & s = 3 \text{ height}(v) + 2 \end{cases}$$

Colesort

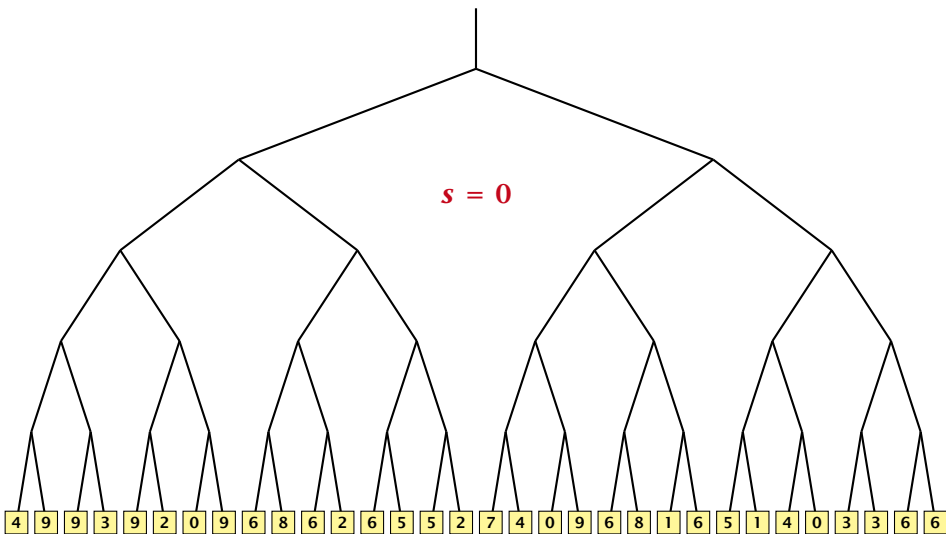

Colesort

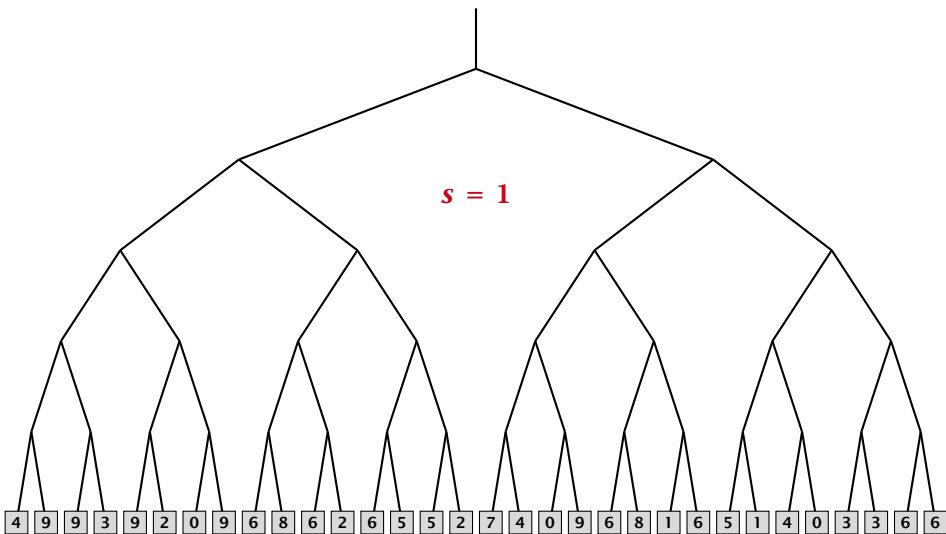

Colesort

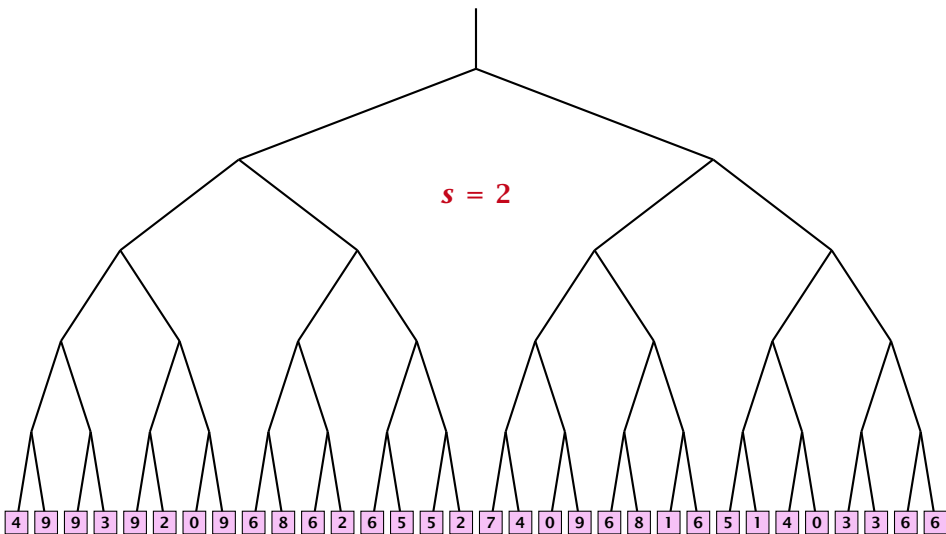

Colesort

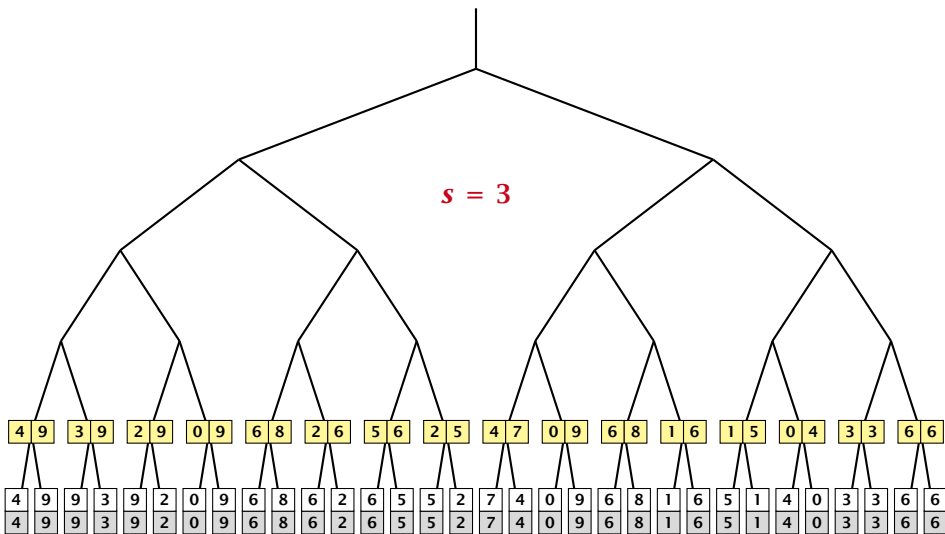

Colesort

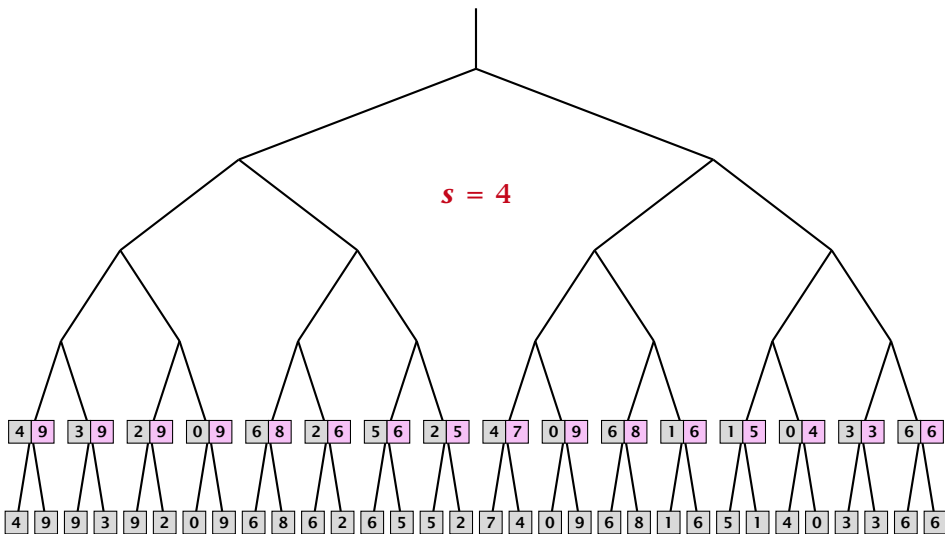

Colesort

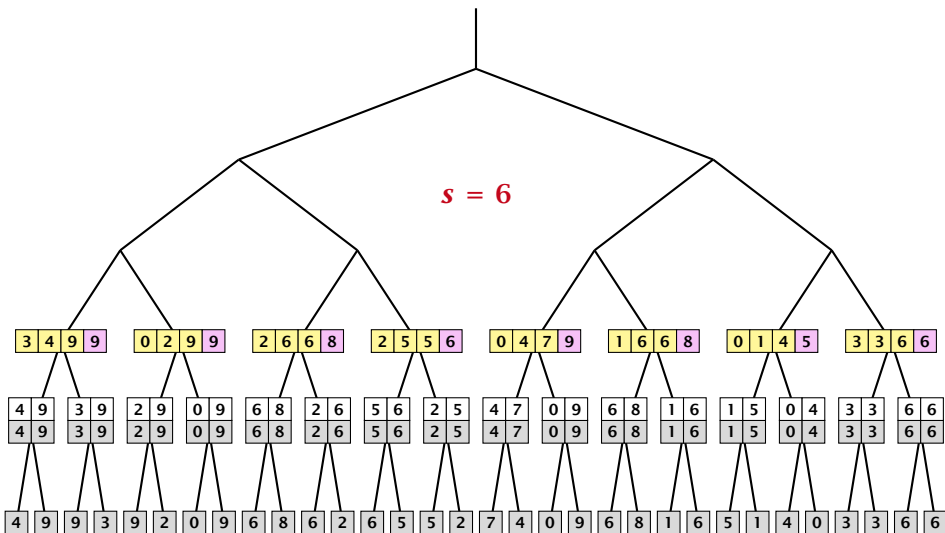

Colesort

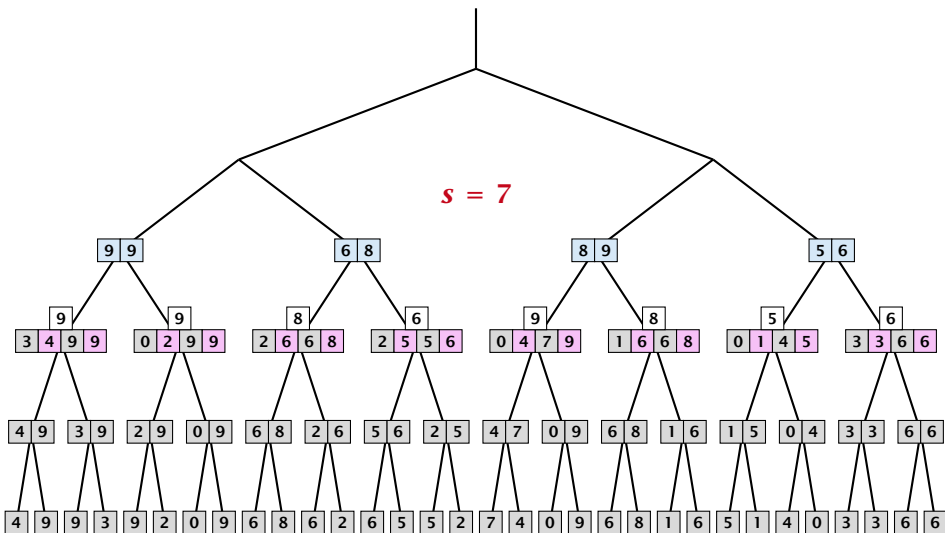

Colesort

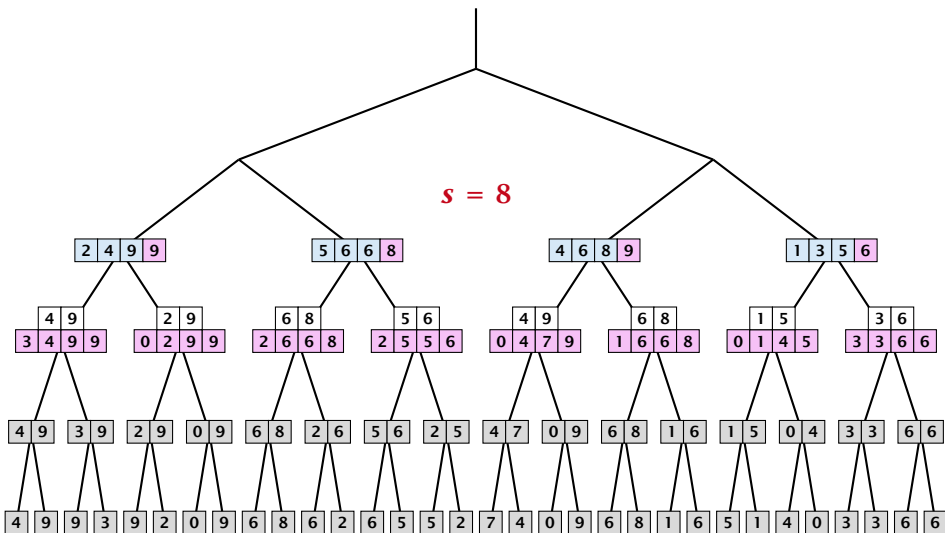

Colesort

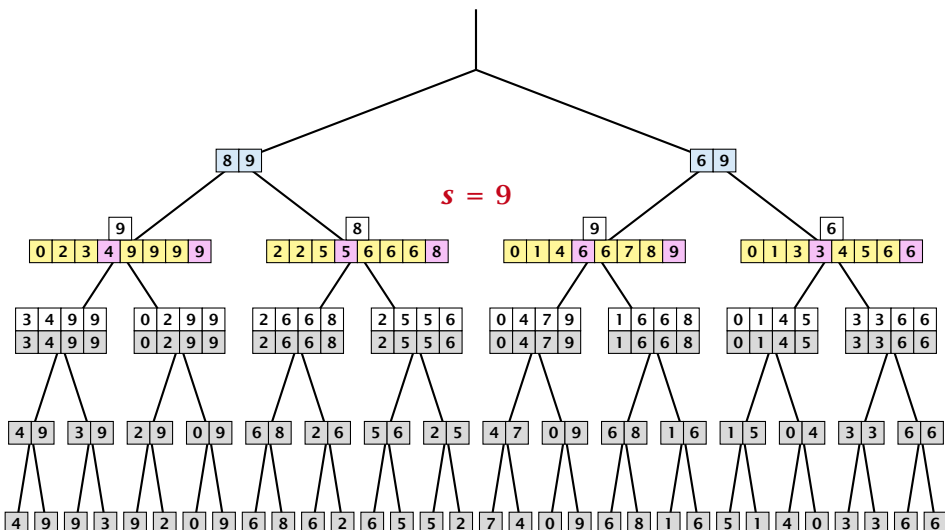

Colesort

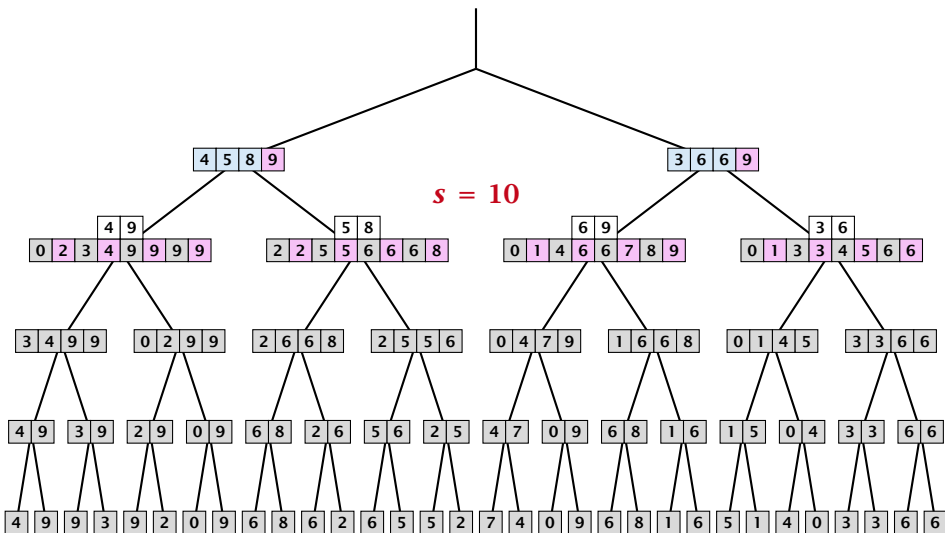

Colesort

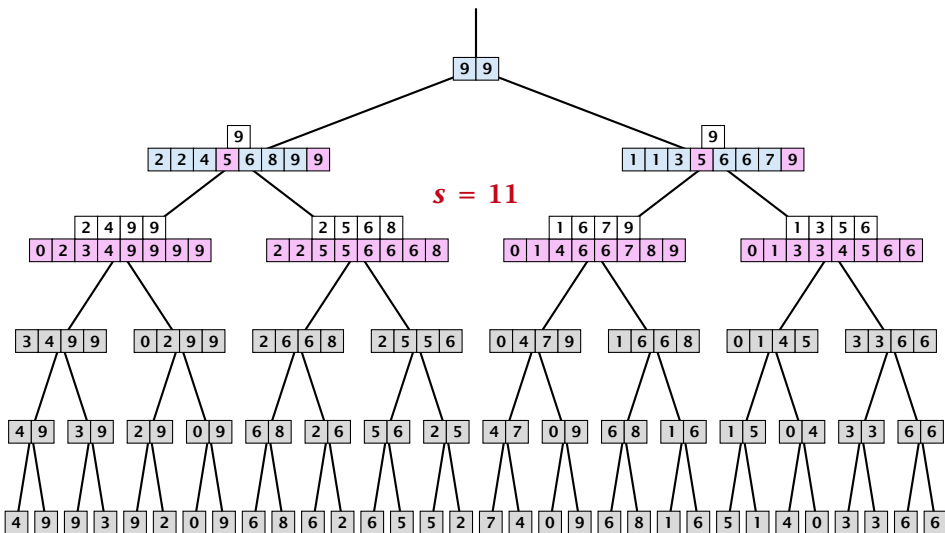

Colesort

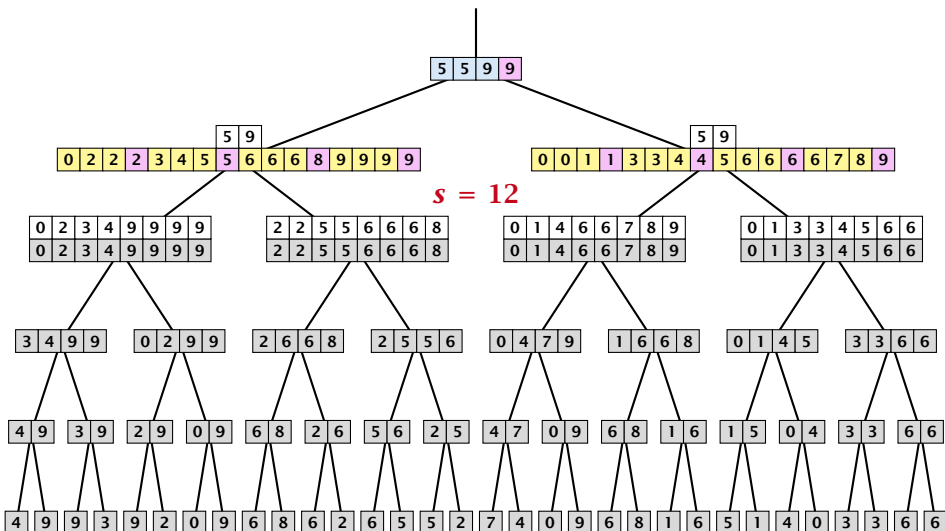

Colesort

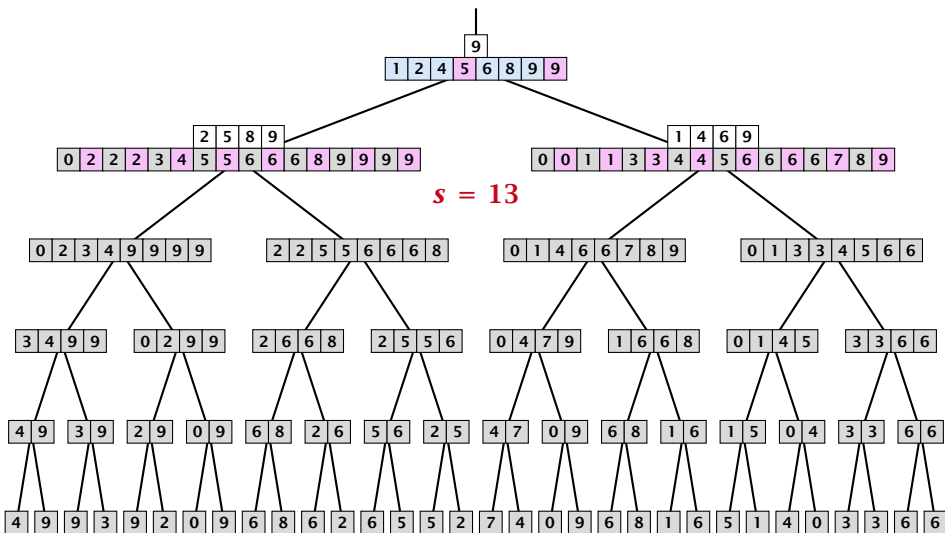

Colesort

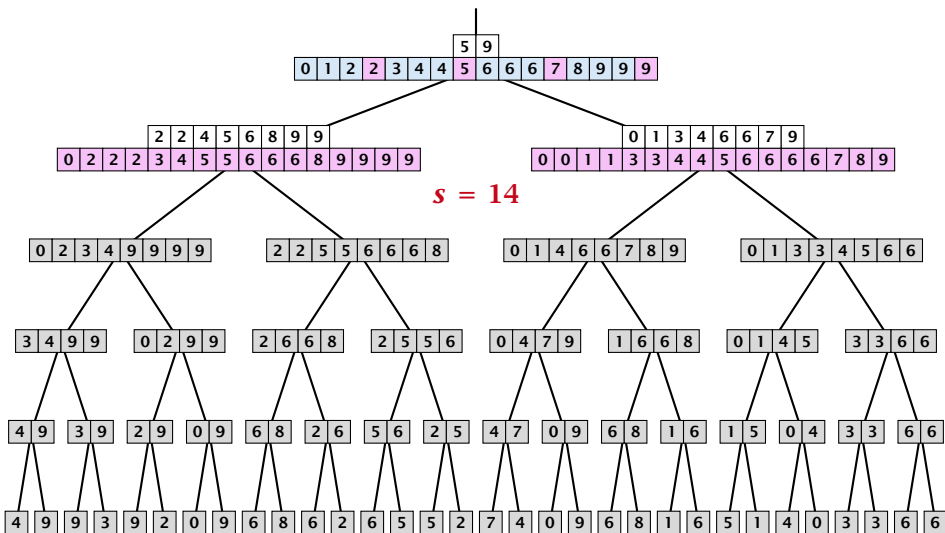

Colesort

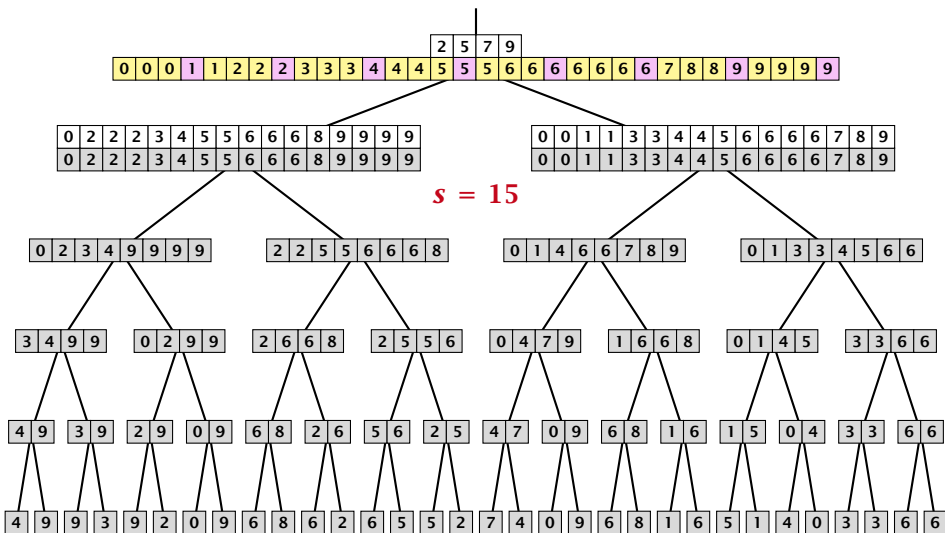

Colesort

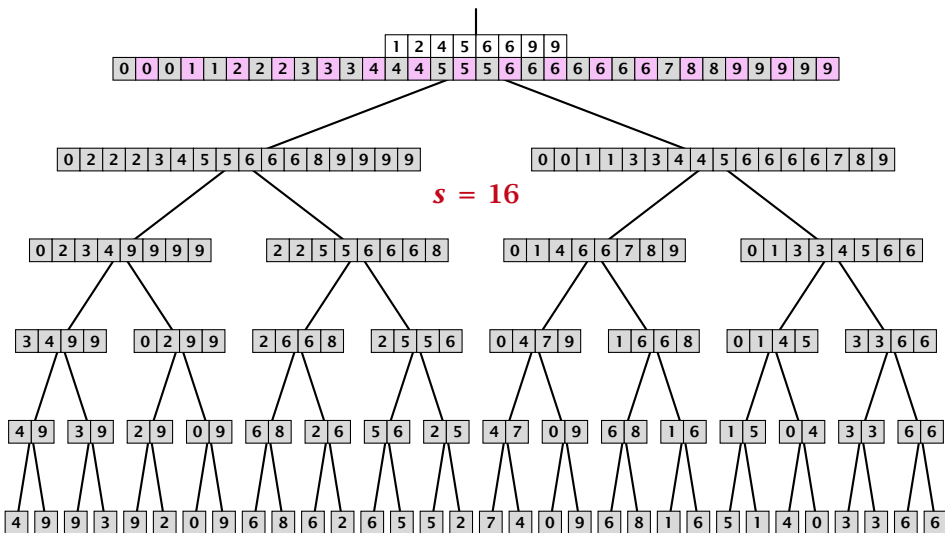

Colesort

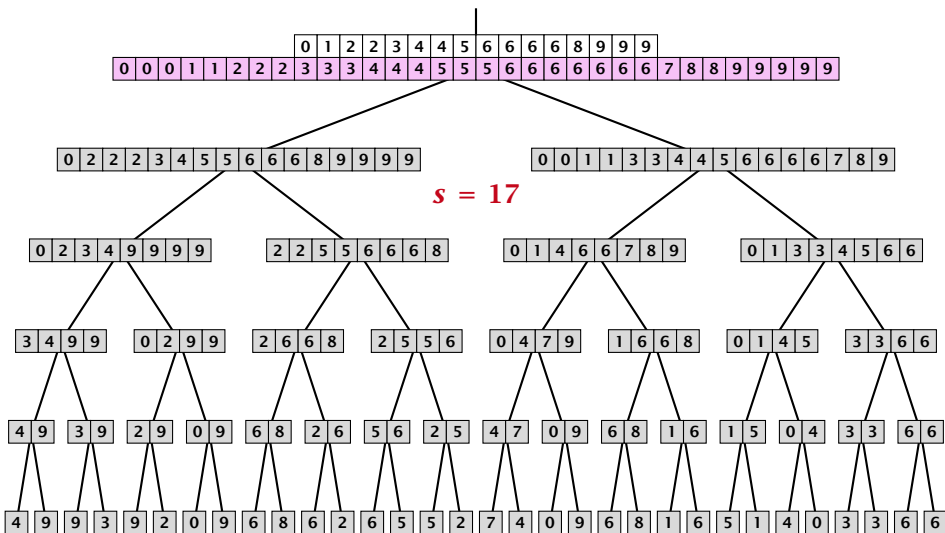

Pipelined Mergesort

Lemma 18

After round $s = 3 \text{ height}(v)$, the list $L_s[v]$ is complete.

Proof:

[Faint, illegible text, likely bleed-through from the reverse side of the slide]

Pipelined Mergesort

Lemma 18

After round $s = 3 \text{ height}(v)$, the list $L_s[v]$ is complete.

Proof:

- ▶ clearly true for leaf nodes
- ▶ suppose it is true for all nodes up to height h ;
- ▶ fix a node v on level $h + 1$ with children u and w
- ▶ $L_{3h}[u]$ and $L_{3h}[w]$ are complete by induction hypothesis
- ▶ further $\text{sample}(L_{3h+2}[u]) = L[u]$ and $\text{sample}(L_{3h+2}[w]) = L[w]$
- ▶ hence in round $3h + 3$ node v will merge the complete list of its children; after the round $L[v]$ will be complete

Pipelined Mergesort

Lemma 18

After round $s = 3 \text{ height}(v)$, the list $L_s[v]$ is complete.

Proof:

- ▶ clearly true for leaf nodes
- ▶ suppose it is true for all nodes up to height h ;
 - ▶ fix a node v on level $h + 1$ with children u and w
 - ▶ $L_{3h}[u]$ and $L_{3h}[w]$ are complete by induction hypothesis
 - ▶ further $\text{sample}(L_{3h+2}[u]) = L[u]$ and $\text{sample}(L_{3h+2}[w]) = L[w]$
 - ▶ hence in round $3h + 3$ node v will merge the complete list of its children; after the round $L[v]$ will be complete

Pipelined Mergesort

Lemma 18

After round $s = 3 \text{ height}(v)$, the list $L_s[v]$ is complete.

Proof:

- ▶ clearly true for leaf nodes
- ▶ suppose it is true for all nodes up to height h ;
- ▶ fix a node v on level $h + 1$ with children u and w
 - ▶ $L_{3h}[u]$ and $L_{3h}[w]$ are complete by induction hypothesis
 - ▶ further $\text{sample}(L_{3h+2}[u]) = L[u]$ and $\text{sample}(L_{3h+2}[w]) = L[w]$
 - ▶ hence in round $3h + 3$ node v will merge the complete list of its children; after the round $L[v]$ will be complete

Pipelined Mergesort

Lemma 18

After round $s = 3 \text{ height}(v)$, the list $L_s[v]$ is complete.

Proof:

- ▶ clearly true for leaf nodes
- ▶ suppose it is true for all nodes up to height h ;
- ▶ fix a node v on level $h + 1$ with children u and w
- ▶ $L_{3h}[u]$ and $L_{3h}[w]$ are complete by induction hypothesis
- ▶ further $\text{sample}(L_{3h+2}[u]) = L[u]$ and $\text{sample}(L_{3h+2}[w]) = L[w]$
- ▶ hence in round $3h + 3$ node v will merge the complete list of its children; after the round $L[v]$ will be complete

Pipelined Mergesort

Lemma 18

After round $s = 3 \text{ height}(v)$, the list $L_s[v]$ is complete.

Proof:

- ▶ clearly true for leaf nodes
- ▶ suppose it is true for all nodes up to height h ;
- ▶ fix a node v on level $h + 1$ with children u and w
- ▶ $L_{3h}[u]$ and $L_{3h}[w]$ are complete by induction hypothesis
- ▶ further $\text{sample}(L_{3h+2}[u]) = L[u]$ and $\text{sample}(L_{3h+2}[v]) = L[v]$
- ▶ hence in round $3h + 3$ node v will merge the complete list of its children; after the round $L[v]$ will be complete

Pipelined Mergesort

Lemma 19

The number of elements in lists $L_S[v]$ for active nodes v is at most $\mathcal{O}(n)$.

proof on board...

Definition 20

A sequence X is a **c -cover** of a sequence Y if for any two consecutive elements α, β from $(-\infty, X, \infty)$ the set $|\{y_i \mid \alpha \leq y_i \leq \beta\}| \leq c$.

Pipelined Mergesort

Lemma 21

$L'_s[v]$ is a 4-cover of $L'_{s+1}[v]$.

If $[a, b]$ fulfills $|[a, b] \cap (A \cup \{-\infty, \infty\})| = k$ we say $[a, b]$ intersects $(-\infty, A, +\infty)$ in k items.

Lemma 22

If $[a, b]$ with $a, b \in L'_s[v] \cup \{-\infty, \infty\}$ intersects $(-\infty, L'_s[v], \infty)$ in $k \geq 2$ items, then $[a, b]$ intersects $(-\infty, L'_{s+1}, \infty)$ in at most $2k$ items.

Pipelined Mergesort

Lemma 21

$L'_s[v]$ is a 4-cover of $L'_{s+1}[v]$.

If $[a, b]$ fulfills $|[a, b] \cap (A \cup \{-\infty, \infty\})| = k$ we say $[a, b]$ intersects $(-\infty, A, +\infty)$ in k items.

Lemma 22

If $[a, b]$ with $a, b \in L'_s[v] \cup \{-\infty, \infty\}$ intersects $(-\infty, L'_s[v], \infty)$ in $k \geq 2$ items, then $[a, b]$ intersects $(-\infty, L'_{s+1}, \infty)$ in at most $2k$ items.

Pipelined Mergesort

Lemma 21

$L'_s[v]$ is a 4-cover of $L'_{s+1}[v]$.

If $[a, b]$ fulfills $|[a, b] \cap (A \cup \{-\infty, \infty\})| = k$ we say $[a, b]$ intersects $(-\infty, A, +\infty)$ in k items.

Lemma 22

If $[a, b]$ with $a, b \in L'_s[v] \cup \{-\infty, \infty\}$ intersects $(-\infty, L'_s[v], \infty)$ in $k \geq 2$ items, then $[a, b]$ intersects $(-\infty, L'_{s+1}, \infty)$ in at most $2k$ items.

$L'_s[\mathbf{v}]$



$L'_s[\mathbf{v}]$



$L'_s[v]$

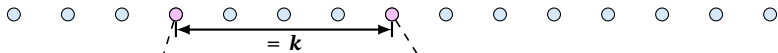

$L_{s-1}[v]$



$L'_s[v]$

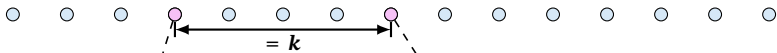

$L_{s-1}[v]$



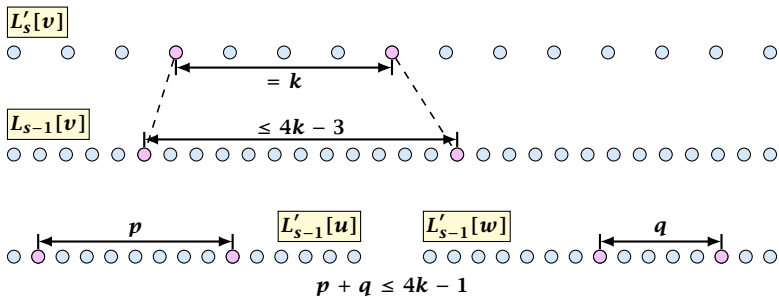

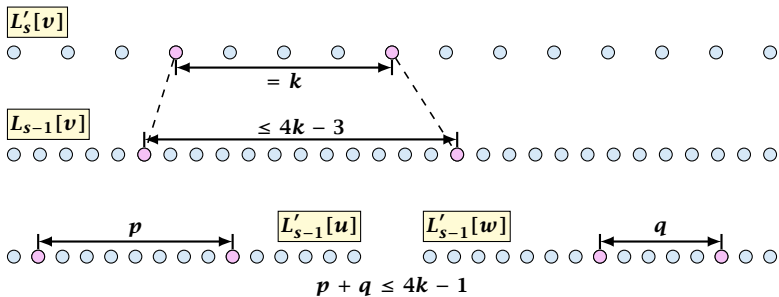

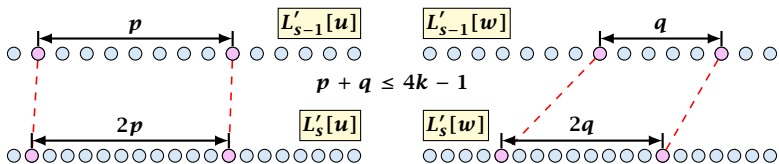
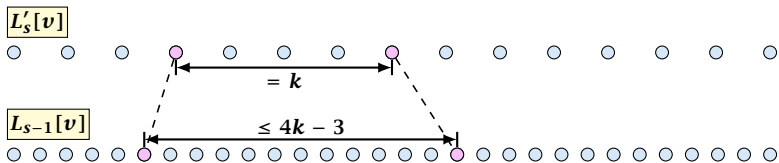

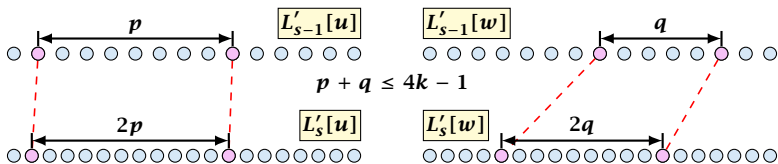
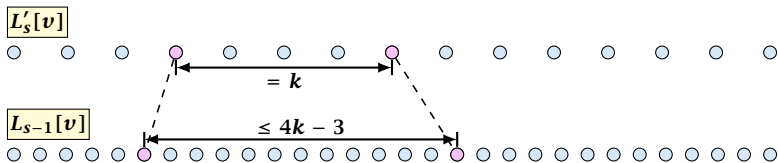

$L'_s[v]$

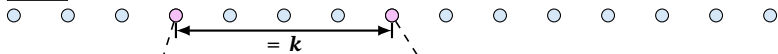

$L_{s-1}[v]$

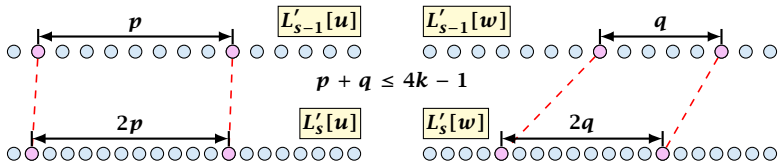

$L_s[v]$

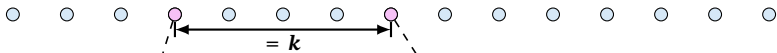
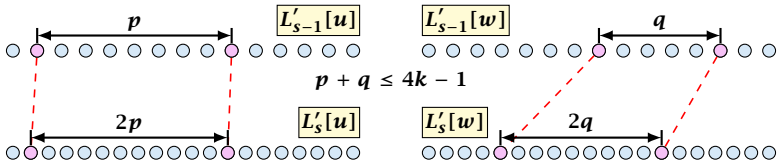

$L'_s[v]$  $L_{s-1}[v]$  $L_s[v]$ 

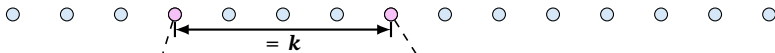
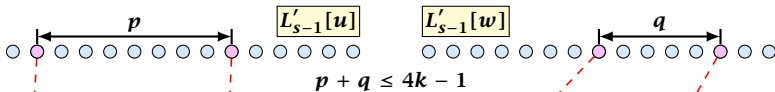
$L'_s[v]$  $L_{s-1}[v]$  $L'_{s-1}[u]$ $L'_{s-1}[w]$

$$p + q \leq 4k - 1$$

 $L'_s[u]$ $L'_s[w]$ $L_s[v]$  $L'_{s+1}[v]$ 

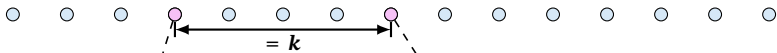
$L'_s[v]$  $L_{s-1}[v]$  $L'_{s-1}[u]$ $L'_{s-1}[w]$

$$p + q \leq 4k - 1$$

 $L_s[v]$  $L'_{s+1}[v]$ 

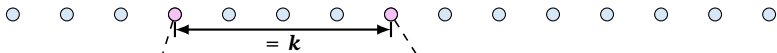
$L'_s[v]$  $L_{s-1}[v]$ 

$$p + q \leq 4k - 1$$

 $L_s[v]$  $L'_{s+1}[v]$ 

Merging with a Cover

Lemma 23

Given two sorted sequences A and B . Let X be a c -cover of A and B for constant c , and let $\text{rank}(X : A)$ and $\text{rank}(X : B)$ be known.

We can merge A and B in time $\mathcal{O}(1)$ using $\mathcal{O}(|X|)$ operations.

Merging with a Cover

Lemma 24

Given two sorted sequences A and B . Let X be a c -cover of B for constant c , and let $\text{rank}(A : X)$ and $\text{rank}(X : B)$ be known.

We can compute $\text{rank}(A : B)$ using $\mathcal{O}(|X| + |A|)$ operations.

Merging with a Cover

Lemma 25

Given two sorted sequences A and B . Let X be a c -cover of B for constant c , and let $\text{rank}(A : X)$ and $\text{rank}(X : B)$ be known.

We can compute $\text{rank}(B : A)$ using $\mathcal{O}(|X| + |A|)$ operations.

Easy to do with **concurrent read**. Can also be done with exclusive read but non-trivial.

In order to do the merge in iteration $s + 1$ in constant time we need to know

$$\text{rank}(L_s[v] : L'_{s+1}[u]) \text{ and } \text{rank}(L_s[v] : L'_{s+1}[w])$$

and we need to know that $L_s[v]$ is a 4-cover of $L'_{s+1}[u]$ and $L'_{s+1}[w]$.

Lemma 26

$L_s[v]$ is a 4-cover of $L'_{s+1}[u]$ and $L'_{s+1}[w]$.

Lemma 26

$L_s[v]$ is a 4-cover of $L'_{s+1}[u]$ and $L'_{s+1}[w]$.

- ▶ $L_s[v] \supseteq L'_s[u], L'_s[w]$
- ▶ $L'_s[u]$ is 4-cover of $L'_{s+1}[u]$
- ▶ Hence, $L_s[v]$ is 4-cover of $L'_{s+1}[u]$ as adding more elements cannot destroy the cover-property.

Lemma 26

$L_s[v]$ is a 4-cover of $L'_{s+1}[u]$ and $L'_{s+1}[w]$.

- ▶ $L_s[v] \supseteq L'_s[u], L'_s[w]$
- ▶ $L'_s[u]$ is 4-cover of $L'_{s+1}[u]$
- ▶ Hence, $L_s[v]$ is 4-cover of $L'_{s+1}[u]$ as adding more elements cannot destroy the cover-property.

Lemma 26

$L_S[v]$ is a 4-cover of $L'_{S+1}[u]$ and $L'_{S+1}[w]$.

- ▶ $L_S[v] \supseteq L'_S[u], L'_S[w]$
- ▶ $L'_S[u]$ is 4-cover of $L'_{S+1}[u]$
- ▶ Hence, $L_S[v]$ is 4-cover of $L'_{S+1}[u]$ as adding more elements cannot destroy the cover-property.

Analysis

Lemma 27

Suppose we know for every internal node v with children u and w

- ▶ $\text{rank}(L'_s[v] : L'_{s+1}[v])$
- ▶ $\text{rank}(L'_s[u] : L'_s[w])$
- ▶ $\text{rank}(L'_s[w] : L'_s[u])$

We can compute

- ▶ $\text{rank}(L'_{s+1}[v] : L'_{s+2}[v])$
- ▶ $\text{rank}(L'_{s+1}[u] : L'_{s+1}[w])$
- ▶ $\text{rank}(L'_{s+1}[w] : L'_{s+1}[u])$

in constant time and $\mathcal{O}(|L_{s+1}[v]|)$ operations, where v is the parent of u and w .

Given

- ▶ $\text{rank}(L'_s[u] : L'_{s+1}[u])$ (**4-cover**)
- ▶ $\text{rank}(L'_s[w] : L'_s[u])$
- ▶ $\text{rank}(L'_s[u] : L'_s[w])$
- ▶ $\text{rank}(L'_s[w] : L'_{s+1}[w])$ (**4-cover**)

Compute

- ▶ $\text{rank}(L'_{s+1}[w] : L'_s[u])$
- ▶ $\text{rank}(L'_{s+1}[u] : L'_s[w])$

Compute

- ▶ $\text{rank}(L'_{s+1}[w] : L'_{s+1}[u])$
- ▶ $\text{rank}(L'_{s+1}[u] : L'_{s+1}[w])$

ranks between siblings can be computed easily

Given

- ▶ $\text{rank}(L'_s[u] : L'_{s+1}[u])$ (**4-cover**)
- ▶ $\text{rank}(L'_s[w] : L'_s[u])$
- ▶ $\text{rank}(L'_s[u] : L'_s[w])$
- ▶ $\text{rank}(L'_s[w] : L'_{s+1}[w])$ (**4-cover**)

Compute

- ▶ $\text{rank}(L'_{s+1}[w] : L'_s[u])$
- ▶ $\text{rank}(L'_{s+1}[u] : L'_s[w])$

Compute

- ▶ $\text{rank}(L'_{s+1}[w] : L'_{s+1}[u])$
- ▶ $\text{rank}(L'_{s+1}[u] : L'_{s+1}[w])$

ranks between siblings can be computed easily

Given

- ▶ $\text{rank}(L'_s[u] : L'_{s+1}[u])$ (**4-cover** \rightarrow $\text{rank}(L'_{s+1}[u] : L'_s[u])$)
- ▶ $\text{rank}(L'_s[w] : L'_{s+1}[w])$
- ▶ $\text{rank}(L'_s[u] : L'_{s+1}[w])$
- ▶ $\text{rank}(L'_s[w] : L'_{s+1}[w])$ (**4-cover** \rightarrow $\text{rank}(L'_{s+1}[w] : L'_s[w])$)

Compute (recall that $L_s[v] = \text{merge}(L'_s[u], L'_s[w])$)

- ▶ $\text{rank}(L_s[v] : L'_{s+1}[u])$
- ▶ $\text{rank}(L_s[v] : L'_{s+1}[w])$

Compute

- ▶ $\text{rank}(L_s[v] : L_{s+1}[v])$ (by adding)
- ▶ $\text{rank}(L'_{s+1}[v] : L'_{s+2}[v])$ (by sampling)

Given

- ▶ $\text{rank}(L'_s[u] : L'_{s+1}[u])$ (**4-cover** $\rightarrow \text{rank}(L'_{s+1}[u] : L'_s[u])$)
- ▶ $\text{rank}(L'_s[w] : L'_{s+1}[u])$
- ▶ $\text{rank}(L'_s[u] : L'_{s+1}[w])$
- ▶ $\text{rank}(L'_s[w] : L'_{s+1}[w])$ (**4-cover** $\rightarrow \text{rank}(L'_{s+1}[w] : L'_s[w])$)

Compute (recall that $L_s[v] = \text{merge}(L'_s[u], L'_s[w])$)

- ▶ $\text{rank}(L_s[v] : L'_{s+1}[u])$
- ▶ $\text{rank}(L_s[v] : L'_{s+1}[w])$

Compute

- ▶ $\text{rank}(L_s[v] : L_{s+1}[v])$ (by adding)
- ▶ $\text{rank}(L'_{s+1}[v] : L'_{s+2}[v])$ (by sampling)

Given

- ▶ $\text{rank}(L'_s[u] : L'_{s+1}[u])$ (**4-cover** $\rightarrow \text{rank}(L'_{s+1}[u] : L'_s[u])$)
- ▶ $\text{rank}(L'_s[w] : L'_{s+1}[u])$
- ▶ $\text{rank}(L'_s[u] : L'_{s+1}[w])$
- ▶ $\text{rank}(L'_s[w] : L'_{s+1}[w])$ (**4-cover** $\rightarrow \text{rank}(L'_{s+1}[w] : L'_s[w])$)

Compute (recall that $L_s[v] = \text{merge}(L'_s[u], L'_s[w])$)

- ▶ $\text{rank}(L_s[v] : L'_{s+1}[u])$
- ▶ $\text{rank}(L_s[v] : L'_{s+1}[w])$

Compute

- ▶ $\text{rank}(L_s[v] : L_{s+1}[v])$ (by adding)
- ▶ $\text{rank}(L'_{s+1}[v] : L'_{s+2}[v])$ (by sampling)

Definition 28

A 0-1 sequence S is **bitonic** if it can be written as the concatenation of subsequences S_1 and S_2 such that either

- ▶ S_1 is monotonically increasing and S_2 monotonically decreasing, or
- ▶ S_1 is monotonically decreasing and S_2 monotonically increasing.

Note, that this just defines **bitonic 0-1 sequences**. Bitonic sequences are defined differently.

Bitonic Merger

If we feed a bitonic 0-1 sequence S into the network on the right we obtain two bitonic sequences S_T and S_B s.t.

1. $S_B \leq S_T$ (element-wise)
2. S_B and S_T are bitonic

Proof:

- ▶ assume wlog. S more 1's than 0's.
- ▶ assume for contradiction two 0s at same comparator ($i, j = i + 2^d$)

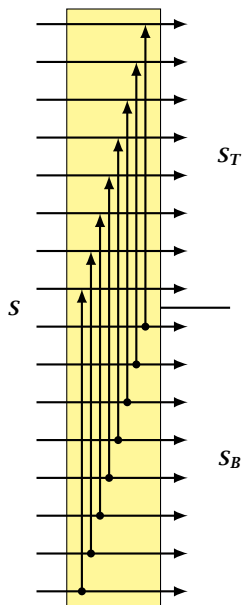

Bitonic Merger

If we feed a bitonic 0-1 sequence S into the network on the right we obtain two bitonic sequences S_T and S_B s.t.

1. $S_B \leq S_T$ (element-wise)
2. S_B and S_T are bitonic

Proof:

- ▶ assume wlog. S more 1's than 0's.
- ▶ assume for contradiction two 0s at same comparator ($i, j = i + 2^d$)
 - ▶ everything 0 btw i and j means we have more than 50% zeros (\neq).
 - ▶ all 1s btw. i and j means we have less than 50% ones (\neq).
 - ▶ 1 btw. i and j and elsewhere means S is not bitonic (\neq).

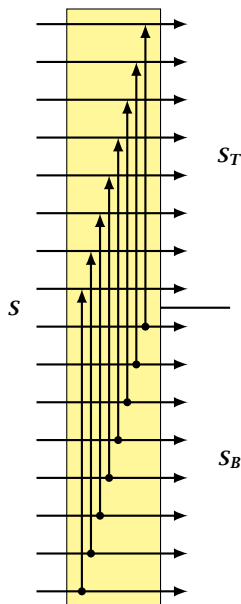

Bitonic Merger

If we feed a bitonic 0-1 sequence S into the network on the right we obtain two bitonic sequences S_T and S_B s.t.

1. $S_B \leq S_T$ (element-wise)
2. S_B and S_T are bitonic

Proof:

- ▶ assume wlog. S more 1's than 0's.
- ▶ assume for contradiction two 0s at same comparator ($i, j = i + 2^d$)
 - ▶ everything 0 btw i and j means we have more than 50% zeros (\neq).
 - ▶ all 1s btw. i and j means we have less than 50% ones (\neq).
 - ▶ 1 btw. i and j and elsewhere means S is not bitonic (\neq).

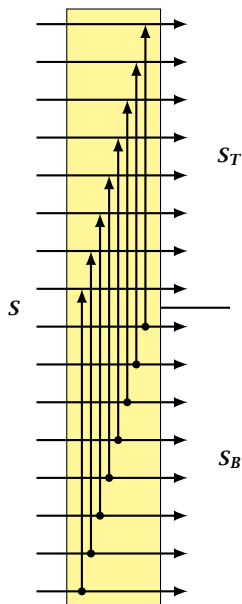

Bitonic Merger

If we feed a bitonic 0-1 sequence S into the network on the right we obtain two bitonic sequences S_T and S_B s.t.

1. $S_B \leq S_T$ (element-wise)
2. S_B and S_T are bitonic

Proof:

- ▶ assume wlog. S more 1's than 0's.
- ▶ assume for contradiction two 0s at same comparator ($i, j = i + 2^d$)
 - ▶ everything 0 btw i and j means we have more than 50% zeros (\neq).
 - ▶ all 1s btw. i and j means we have less than 50% ones (\neq).
 - ▶ 1 btw. i and j and elsewhere means S is not bitonic (\neq).

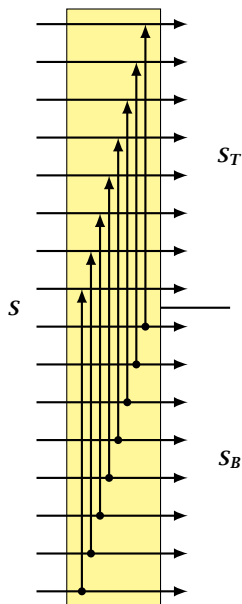

Bitonic Merger

If we feed a bitonic 0-1 sequence S into the network on the right we obtain two bitonic sequences S_T and S_B s.t.

1. $S_B \leq S_T$ (element-wise)
2. S_B and S_T are bitonic

Proof:

- ▶ assume wlog. S more 1's than 0's.
- ▶ assume for contradiction two 0s at same comparator ($i, j = i + 2^d$)
 - ▶ everything 0 btw i and j means we have more than 50% zeros (\neq).
 - ▶ all 1s btw. i and j means we have less than 50% ones (\neq).
 - ▶ 1 btw. i and j and elsewhere means S is not bitonic (\neq).

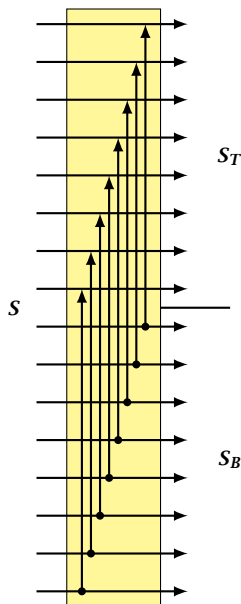

Bitonic Merger

Bitonic Merger B_d

The bitonic merger B_d of dimension d is constructed by combining two bitonic mergers of dimension $d - 1$.

If we feed a bitonic 0-1 sequence into this, the sequence will be sorted.

(actually, any bitonic sequence will be sorted, but we do not prove this)

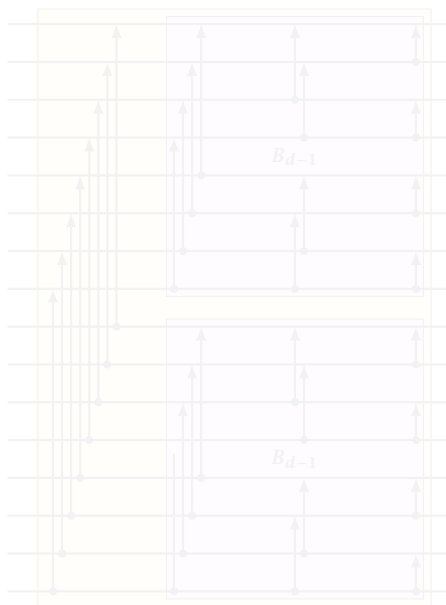

Bitonic Merger

Bitonic Merger B_d

The bitonic merger B_d of dimension d is constructed by combining two bitonic mergers of dimension $d - 1$.

If we feed a bitonic 0-1 sequence into this, the sequence will be sorted.

(actually, any bitonic sequence will be sorted, but we do not prove this)

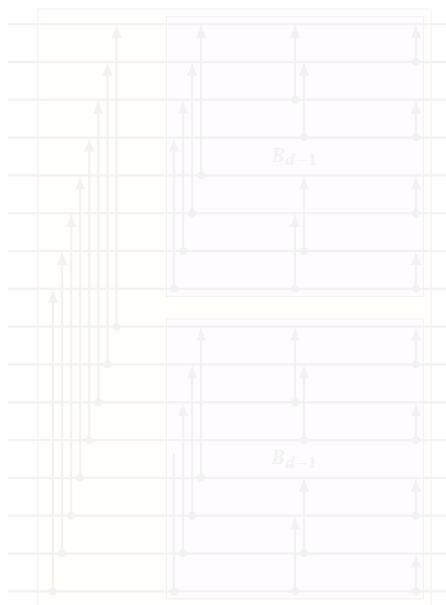

Bitonic Merger

Bitonic Merger B_d

The bitonic merger B_d of dimension d is constructed by combining two bitonic mergers of dimension $d - 1$.

If we feed a bitonic 0-1 sequence into this, the sequence will be sorted.

(actually, any bitonic sequence will be sorted, but we do not prove this)

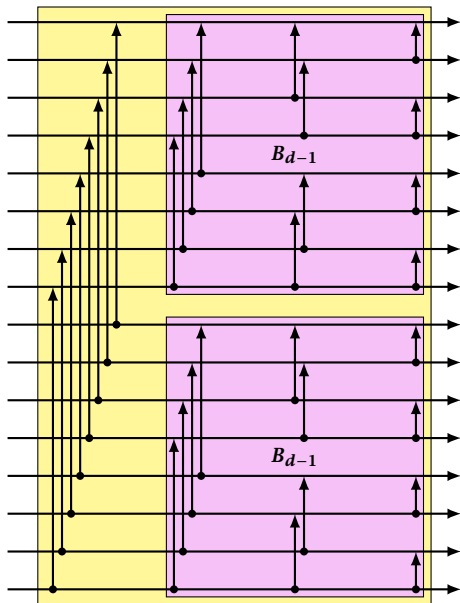

Bitonic Sorter S_d

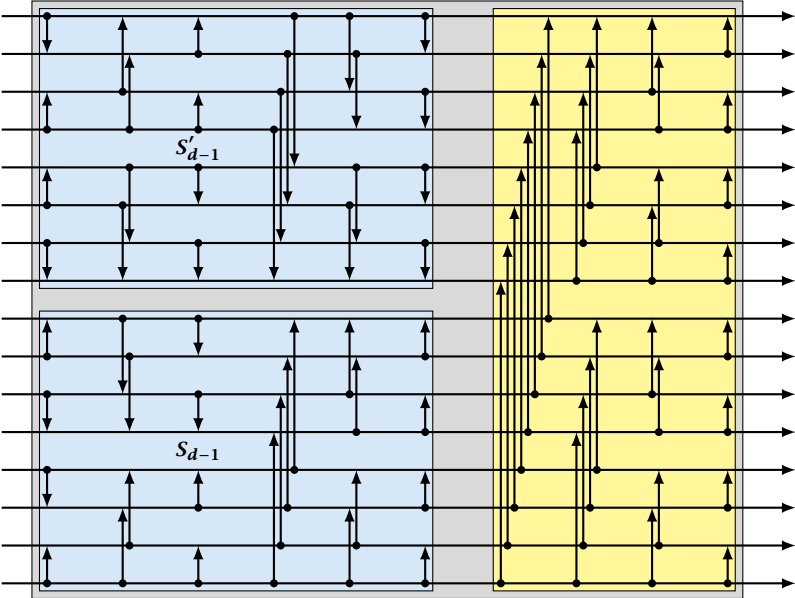

Bitonic Merger: ($n = 2^d$)

- ▶ comparators: $C(n) = 2C(n/2) + n/2 \Rightarrow C(n) = \mathcal{O}(n \log n)$.

$$\text{depth: } D(n) = D(n/2) + 1 \Rightarrow D(n) = \mathcal{O}(\log n).$$

Bitonic Sorter: ($n = 2^d$)

$$\text{comparators: } C(n) = 2C(n/2) + \mathcal{O}(n \log n) =$$

$$\mathcal{O}(n) = \mathcal{O}(n \log^2 n).$$

$$\text{depth: } D(n) = D(n/2) + \log n = D(n) = \mathcal{O}(n \log^2 n).$$

Bitonic Merger: ($n = 2^d$)

- ▶ comparators: $C(n) = 2C(n/2) + n/2 \Rightarrow C(n) = \mathcal{O}(n \log n)$.

$$\text{depth: } D(n) = D(n/2) + 1 \Rightarrow D(n) = \mathcal{O}(\log n).$$

Bitonic Sorter: ($n = 2^d$)

$$\text{comparators: } C(n) = 2C(n/2) + \mathcal{O}(n \log n) \Rightarrow$$

$$C(n) = \mathcal{O}(n \log^2 n).$$

$$\text{depth: } D(n) = D(n/2) + \log n \Rightarrow D(n) = \mathcal{O}(n \log^2 n).$$

Bitonic Merger: ($n = 2^d$)

- ▶ comparators: $C(n) = 2C(n/2) + n/2 \Rightarrow C(n) = \mathcal{O}(n \log n)$.
- ▶ depth: $D(n) = D(n/2) + 1 \Rightarrow D(d) = \mathcal{O}(\log n)$.

Bitonic Sorter: ($n = 2^d$)

comparators: $C(n) = 2C(n/2) + \mathcal{O}(n \log n) \Rightarrow$

$C(n) = \mathcal{O}(n \log^2 n)$.

depth: $D(n) = D(n/2) + \log n \Rightarrow D(n) = \mathcal{O}(n \log^2 n)$.

Bitonic Merger: ($n = 2^d$)

- ▶ comparators: $C(n) = 2C(n/2) + n/2 \Rightarrow C(n) = \mathcal{O}(n \log n)$.
- ▶ depth: $D(n) = D(n/2) + 1 \Rightarrow D(d) = \mathcal{O}(\log n)$.

Bitonic Sorter: ($n = 2^d$)

comparators: $C(n) = 2C(n/2) + \mathcal{O}(n \log n) \Rightarrow$

$C(n) = \mathcal{O}(n \log^2 n)$.

depth: $D(n) = D(n/2) + \log n \Rightarrow D(n) = \mathcal{O}(n \log^2 n)$.

Bitonic Merger: ($n = 2^d$)

- ▶ comparators: $C(n) = 2C(n/2) + n/2 \Rightarrow C(n) = \mathcal{O}(n \log n)$.
- ▶ depth: $D(n) = D(n/2) + 1 \Rightarrow D(d) = \mathcal{O}(\log n)$.

Bitonic Sorter: ($n = 2^d$)

- ▶ comparators: $C(n) = 2C(n/2) + \mathcal{O}(n \log n) \Rightarrow$
 $C(n) = \mathcal{O}(n \log^2 n)$.

Depth: $D(n) = D(n/2) + \mathcal{O}(\log n) \Rightarrow D(d) = \mathcal{O}(\log^2 n)$

Bitonic Merger: ($n = 2^d$)

- ▶ comparators: $C(n) = 2C(n/2) + n/2 \Rightarrow C(n) = \mathcal{O}(n \log n)$.
- ▶ depth: $D(n) = D(n/2) + 1 \Rightarrow D(d) = \mathcal{O}(\log n)$.

Bitonic Sorter: ($n = 2^d$)

- ▶ comparators: $C(n) = 2C(n/2) + \mathcal{O}(n \log n) \Rightarrow$
 $C(n) = \mathcal{O}(n \log^2 n)$.

Depth: $D(n) = D(n/2) + \mathcal{O}(\log n) \Rightarrow D(n) = \mathcal{O}(\log^2 n)$

Bitonic Merger: ($n = 2^d$)

- ▶ comparators: $C(n) = 2C(n/2) + n/2 \Rightarrow C(n) = \mathcal{O}(n \log n)$.
- ▶ depth: $D(n) = D(n/2) + 1 \Rightarrow D(d) = \mathcal{O}(\log n)$.

Bitonic Sorter: ($n = 2^d$)

- ▶ comparators: $C(n) = 2C(n/2) + \mathcal{O}(n \log n) \Rightarrow C(n) = \mathcal{O}(n \log^2 n)$.
- ▶ depth: $D(n) = D(n/2) + \log n \Rightarrow D(n) = \Theta(\log^2 n)$.

Bitonic Merger: ($n = 2^d$)

- ▶ comparators: $C(n) = 2C(n/2) + n/2 \Rightarrow C(n) = \mathcal{O}(n \log n)$.
- ▶ depth: $D(n) = D(n/2) + 1 \Rightarrow D(d) = \mathcal{O}(\log n)$.

Bitonic Sorter: ($n = 2^d$)

- ▶ comparators: $C(n) = 2C(n/2) + \mathcal{O}(n \log n) \Rightarrow C(n) = \mathcal{O}(n \log^2 n)$.
- ▶ depth: $D(n) = D(n/2) + \log n \Rightarrow D(n) = \Theta(\log^2 n)$.

Bitonic Merger: ($n = 2^d$)

- ▶ comparators: $C(n) = 2C(n/2) + n/2 \Rightarrow C(n) = \mathcal{O}(n \log n)$.
- ▶ depth: $D(n) = D(n/2) + 1 \Rightarrow D(d) = \mathcal{O}(\log n)$.

Bitonic Sorter: ($n = 2^d$)

- ▶ comparators: $C(n) = 2C(n/2) + \mathcal{O}(n \log n) \Rightarrow C(n) = \mathcal{O}(n \log^2 n)$.
- ▶ depth: $D(n) = D(n/2) + \log n \Rightarrow D(n) = \Theta(\log^2 n)$.

Odd-Even Merge

How to merge two sorted sequences?

$A = (a_1, a_2, \dots, a_n), B = (b_1, b_2, \dots, b_n), n$ even.

Split into odd and even sequences:

$A_{\text{odd}} = (a_1, a_3, a_5, \dots, a_{n-1}), A_{\text{even}} = (a_2, a_4, a_6, \dots, a_n)$

$B_{\text{odd}} = (b_1, b_3, b_5, \dots, b_{n-1}), B_{\text{even}} = (b_2, b_4, b_6, \dots, b_n)$

Let

$X = \text{merge}(A_{\text{odd}}, B_{\text{odd}})$ and $Y = \text{merge}(A_{\text{even}}, B_{\text{even}})$

Then

$S = (x_1, \min\{x_2, y_1\}, \max\{x_2, y_1\}, \min\{x_3, y_2\}, \dots, y_n)$

Odd-Even Merge

How to merge two sorted sequences?

$A = (a_1, a_2, \dots, a_n)$, $B = (b_1, b_2, \dots, b_n)$, n even.

Split into odd and even sequences:

$A_{\text{odd}} = (a_1, a_3, a_5, \dots, a_{n-1})$, $A_{\text{even}} = (a_2, a_4, a_6, \dots, a_n)$

$B_{\text{odd}} = (b_1, b_3, b_5, \dots, b_{n-1})$, $B_{\text{even}} = (b_2, b_4, b_6, \dots, b_n)$

Let

$X = \text{merge}(A_{\text{odd}}, B_{\text{odd}})$ and $Y = \text{merge}(A_{\text{even}}, B_{\text{even}})$

Then

$S = (x_1, \min\{x_2, y_1\}, \max\{x_2, y_1\}, \min\{x_3, y_2\}, \dots, y_n)$

Odd-Even Merge

How to merge two sorted sequences?

$A = (a_1, a_2, \dots, a_n)$, $B = (b_1, b_2, \dots, b_n)$, n even.

Split into odd and even sequences:

$A_{\text{odd}} = (a_1, a_3, a_5, \dots, a_{n-1})$, $A_{\text{even}} = (a_2, a_4, a_6, \dots, a_n)$

$B_{\text{odd}} = (b_1, b_3, b_5, \dots, b_{n-1})$, $B_{\text{even}} = (b_2, b_4, b_6, \dots, b_n)$

Let

$X = \text{merge}(A_{\text{odd}}, B_{\text{odd}})$ and $Y = \text{merge}(A_{\text{even}}, B_{\text{even}})$

Then

$S = (x_1, \min\{x_2, y_1\}, \max\{x_2, y_1\}, \min\{x_3, y_2\}, \dots, y_n)$

Odd-Even Merge

How to merge two sorted sequences?

$A = (a_1, a_2, \dots, a_n)$, $B = (b_1, b_2, \dots, b_n)$, n even.

Split into odd and even sequences:

$A_{\text{odd}} = (a_1, a_3, a_5, \dots, a_{n-1})$, $A_{\text{even}} = (a_2, a_4, a_6, \dots, a_n)$

$B_{\text{odd}} = (b_1, b_3, b_5, \dots, b_{n-1})$, $B_{\text{even}} = (b_2, b_4, b_6, \dots, b_n)$

Let

$X = \text{merge}(A_{\text{odd}}, B_{\text{odd}})$ and $Y = \text{merge}(A_{\text{even}}, B_{\text{even}})$

Then

$S = (x_1, \min\{x_2, y_1\}, \max\{x_2, y_1\}, \min\{x_3, y_2\}, \dots, y_n)$

Odd-Even Merge

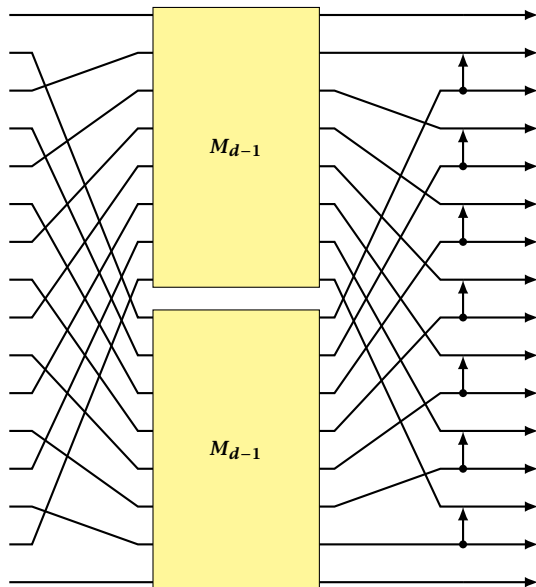

Theorem 29

There exists a sorting network with depth $\mathcal{O}(\log n)$ and $\mathcal{O}(n \log n)$ comparators.

Parallel Comparison Tree Model

A parallel comparison tree (with parallelism p) is a 3^p -ary tree.

- ▶ each internal node represents a set of p comparisons btw. p pairs (not necessarily distinct)
- ▶ a leaf v corresponds to a unique permutation that is valid for all the comparisons on the path from the root to v
- ▶ the number of parallel steps is the height of the tree

Parallel Comparison Tree Model

A parallel comparison tree (with parallelism p) is a 3^p -ary tree.

- ▶ each internal node represents a set of p comparisons btw. p pairs (not necessarily distinct)
- ▶ a leaf v corresponds to a unique permutation that is valid for all the comparisons on the path from the root to v
- ▶ the number of parallel steps is the height of the tree

Parallel Comparison Tree Model

A parallel comparison tree (with parallelism p) is a 3^p -ary tree.

- ▶ each internal node represents a set of p comparisons btw. p pairs (not necessarily distinct)
- ▶ a leaf v corresponds to a unique permutation that is valid for all the comparisons on the path from the root to v
- ▶ the number of parallel steps is the height of the tree

Comparison PRAM

A comparison PRAM is a PRAM where we can only compare the input elements;

- ▶ we cannot view them as strings
- ▶ we cannot do calculations on them

A lower bound for the comparison tree with parallelism p directly carries over to the comparison PRAM with p processors.

Comparison PRAM

A comparison PRAM is a PRAM where we can only compare the input elements;

- ▶ we cannot view them as strings
- ▶ we cannot do calculations on them

A lower bound for the comparison tree with parallelism p directly carries over to the comparison PRAM with p processors.

Comparison PRAM

A comparison PRAM is a PRAM where we can only compare the input elements;

- ▶ we cannot view them as strings
- ▶ we cannot do calculations on them

A lower bound for the comparison tree with parallelism p directly carries over to the comparison PRAM with p processors.

Comparison PRAM

A comparison PRAM is a PRAM where we can only compare the input elements;

- ▶ we cannot view them as strings
- ▶ we cannot do calculations on them

A lower bound for the comparison tree with parallelism p directly carries over to the comparison PRAM with p processors.

A Lower Bound for Searching

Theorem 30

Given a sorted table X of n elements and an element y . Searching for y in X requires $\Omega\left(\frac{\log n}{\log(p+1)}\right)$ steps in the parallel comparison tree with parallelism $p < n$.

A Lower Bound for Maximum

Theorem 31

A graph G with m edges and n vertices has an independent set on at least $\frac{n^2}{2m+n}$ vertices.

base case ($n = 1$)

- ▶ The only graph with one vertex has $m = 0$, and an independent set of size 1.

A Lower Bound for Maximum

Theorem 31

A graph G with m edges and n vertices has an independent set on at least $\frac{n^2}{2m+n}$ vertices.

base case ($n = 1$)

- ▶ The only graph with one vertex has $m = 0$, and an independent set of size 1.

A Lower Bound for Maximum

Theorem 31

A graph G with m edges and n vertices has an independent set on at least $\frac{n^2}{2m+n}$ vertices.

base case ($n = 1$)

- ▶ The only graph with one vertex has $m = 0$, and an independent set of size 1.

induction step ($1, \dots, n \rightarrow n + 1$)

- ▶ Let G be a graph with $n + 1$ vertices, and v a node with minimum degree (d).
- ▶ Let G' be the graph after deleting v and its adjacent vertices in G .
- ▶ $n' = n - (d + 1)$
- ▶ $m' \leq m - \frac{d}{2}(d + 1)$ as we remove $d + 1$ vertices, each with degree at least d
- ▶ In G' there is an independent set of size $((n')^2 / (2m' + n'))$.
- ▶ By adding v we obtain an independent set of size

$$1 + \frac{(n')^2}{2m' + n'} \geq \frac{n^2}{2m + n}$$

induction step ($1, \dots, n \rightarrow n + 1$)

- ▶ Let G be a graph with $n + 1$ vertices, and v a node with minimum degree (d).
- ▶ Let G' be the graph after deleting v and its adjacent vertices in G .
- ▶ $n' = n - (d + 1)$
- ▶ $m' \leq m - \frac{d}{2}(d + 1)$ as we remove $d + 1$ vertices, each with degree at least d
- ▶ In G' there is an independent set of size $((n')^2 / (2m' + n'))$.
- ▶ By adding v we obtain an independent set of size

$$1 + \frac{(n')^2}{2m' + n'} \geq \frac{n^2}{2m + n}$$

induction step ($1, \dots, n \rightarrow n + 1$)

- ▶ Let G be a graph with $n + 1$ vertices, and v a node with minimum degree (d).
- ▶ Let G' be the graph after deleting v and its adjacent vertices in G .
- ▶ $n' = n - (d + 1)$
- ▶ $m' \leq m - \frac{d}{2}(d + 1)$ as we remove $d + 1$ vertices, each with degree at least d
- ▶ In G' there is an independent set of size $((n')^2 / (2m' + n'))$.
- ▶ By adding v we obtain an independent set of size

$$1 + \frac{(n')^2}{2m' + n'} \geq \frac{n^2}{2m + n}$$

induction step ($1, \dots, n \rightarrow n + 1$)

- ▶ Let G be a graph with $n + 1$ vertices, and v a node with minimum degree (d).
- ▶ Let G' be the graph after deleting v and its adjacent vertices in G .
- ▶ $n' = n - (d + 1)$
- ▶ $m' \leq m - \frac{d}{2}(d + 1)$ as we remove $d + 1$ vertices, each with degree at least d
- ▶ In G' there is an independent set of size $((n')^2 / (2m' + n'))$.
- ▶ By adding v we obtain an independent set of size

$$1 + \frac{(n')^2}{2m' + n'} \geq \frac{n^2}{2m + n}$$

induction step ($1, \dots, n \rightarrow n + 1$)

- ▶ Let G be a graph with $n + 1$ vertices, and v a node with minimum degree (d).
- ▶ Let G' be the graph after deleting v and its adjacent vertices in G .
- ▶ $n' = n - (d + 1)$
- ▶ $m' \leq m - \frac{d}{2}(d + 1)$ as we remove $d + 1$ vertices, each with degree at least d
- ▶ In G' there is an independent set of size $((n')^2 / (2m' + n'))$.
- ▶ By adding v we obtain an independent set of size

$$1 + \frac{(n')^2}{2m' + n'} \geq \frac{n^2}{2m + n}$$

induction step ($1, \dots, n \rightarrow n + 1$)

- ▶ Let G be a graph with $n + 1$ vertices, and v a node with minimum degree (d).
- ▶ Let G' be the graph after deleting v and its adjacent vertices in G .
- ▶ $n' = n - (d + 1)$
- ▶ $m' \leq m - \frac{d}{2}(d + 1)$ as we remove $d + 1$ vertices, each with degree at least d
- ▶ In G' there is an independent set of size $((n')^2 / (2m' + n'))$.
- ▶ By adding v we obtain an independent set of size

$$1 + \frac{(n')^2}{2m' + n'} \geq \frac{n^2}{2m + n}$$

A Lower Bound for Maximum

Theorem 32

Computing the maximum of n elements in the comparison tree requires $\Omega(\log \log n)$ steps whenever the degree of parallelism is $p \leq n$.

Theorem 33

Computing the maximum of n elements requires $\Omega(\log \log n)$ steps on the comparison PRAM with n processors.

A Lower Bound for Maximum

Theorem 32

Computing the maximum of n elements in the comparison tree requires $\Omega(\log \log n)$ steps whenever the degree of parallelism is $p \leq n$.

Theorem 33

Computing the maximum of n elements requires $\Omega(\log \log n)$ steps on the comparison PRAM with n processors.

An adversary can specify the input such that at the end of the $(i + 1)$ -st step the maximum lies in a set C_{i+1} of size s_{i+1} such that

- ▶ no two elements of C_{i+1} have been compared

- ▶ $s_{i+1} \geq \frac{s_i^2}{2p+c_i}$

An adversary can specify the input such that at the end of the $(i + 1)$ -st step the maximum lies in a set C_{i+1} of size s_{i+1} such that

- ▶ no two elements of C_{i+1} have been compared
- ▶ $s_{i+1} \geq \frac{s_i^2}{2p+c_i}$

Theorem 34

The selection problem requires $\Omega(\log n / \log \log n)$ steps on a comparison PRAM.

not proven yet

A Lower Bound for Merging

The (k, s) -merging problem, asks to merge k pairs of subsequences A^1, \dots, A^k and B^1, \dots, B^k where we know that all elements in $A^i \cup B^i$ are smaller than elements in $A^j \cup B^j$ for $(i < j)$. Further $|A_i|, |B_i| \geq s$.

A Lower Bound for Merging

Lemma 35

Suppose we are given a parallel comparison tree with parallelism p to solve the (k, s) merging problem. After the first step an adversary can specify the input such that an arbitrary (k', s') merging problem has to be solved, where

$$k' = \frac{3}{4}\sqrt{pk}$$

$$s' = \frac{s}{4}\sqrt{\frac{k}{p}}$$

A Lower Bound for Merging

Partition A^i s and B^i s into blocks of length roughly s/ℓ ; hence ℓ blocks.

Define an $\ell \times \ell$ binary matrix M^i , where M^i_{xy} is 0 iff the parallel step **did not** compare an element from A^i_x with an element from B^i_y .

The matrix has $2\ell - 1$ diagonals.

A Lower Bound for Merging

Partition A^i s and B^i s into blocks of length roughly s/ℓ ; hence ℓ blocks.

Define an $\ell \times \ell$ binary matrix M^i , where M^i_{xy} is 0 iff the parallel step **did not** compare an element from A^i_x with an element from B^i_y .

The matrix has $2\ell - 1$ diagonals.

A Lower Bound for Merging

Partition A^i s and B^i s into blocks of length roughly s/ℓ ; hence ℓ blocks.

Define an $\ell \times \ell$ binary matrix M^i , where M^i_{xy} is 0 iff the parallel step **did not** compare an element from A^i_x with an element from B^i_y .

The matrix has $2\ell - 1$ diagonals.

Choose for every i the diagonal of M^i that has most zeros.

Pair all $A_{j+d_i}^i, B_j^i$, (where $d_i \in \{-(\ell - 1), \dots, \ell - 1\}$ specifies the chosen diagonal) for which the entry in M^i is zero.

We can choose value s.t. elements for the j -th pair along the diagonal are **all** smaller than for the $(j + 1)$ -th pair.

Hence, we get a (k', s') problem.

Choose for every i the diagonal of M^i that has most zeros.

Pair all $A_{j+d_i}^i, B_j^i$, (where $d_i \in \{-(\ell-1), \dots, \ell-1\}$ specifies the chosen diagonal) for which the entry in M^i is zero.

We can choose value s.t. elements for the j -th pair along the diagonal are all smaller than for the $(j+1)$ -th pair.

Hence, we get a (k', s') problem.

Choose for every i the diagonal of M^i that has most zeros.

Pair all $A_{j+d_i}^i, B_j^i$, (where $d_i \in \{-(\ell - 1), \dots, \ell - 1\}$ specifies the chosen diagonal) for which the entry in M^i is zero.

We can choose value s.t. elements for the j -th pair along the diagonal are all smaller than for the $(j + 1)$ -th pair.

Hence, we get a (k', s') problem.

Choose for every i the diagonal of M^i that has most zeros.

Pair all $A_{j+d_i}^i, B_j^i$, (where $d_i \in \{-(\ell - 1), \dots, \ell - 1\}$ specifies the chosen diagonal) for which the entry in M^i is zero.

We can choose value s.t. elements for the j -th pair along the diagonal are **all** smaller than for the $(j + 1)$ -th pair.

Hence, we get a (k', s') problem.

Choose for every i the diagonal of M^i that has most zeros.

Pair all $A_{j+d_i}^i, B_j^i$, (where $d_i \in \{-(\ell - 1), \dots, \ell - 1\}$ specifies the chosen diagonal) for which the entry in M^i is zero.

We can choose value s.t. elements for the j -th pair along the diagonal are **all** smaller than for the $(j + 1)$ -th pair.

Hence, we get a (k', s') problem.

How many pairs do we have?

- ▶ there are $k\ell$ blocks in total
- ▶ there are $k \cdot \ell^2$ matrix entries in total
- ▶ there are at least $k \cdot \ell^2 - p$ zeros.
- ▶ choosing a random diagonal (same for every matrix M^i) hits at least

$$\frac{k\ell^2 - p}{2\ell - 1} \geq \frac{k\ell}{2} - \frac{p}{2\ell}$$

zeroes.

- ▶ Choosing $\ell = \lceil 2\sqrt{p/k} \rceil$ gives

$$k' \geq \frac{3}{4}\sqrt{pk} \text{ and } s' = \lfloor \frac{s}{\ell} \rfloor \geq \frac{s}{4\sqrt{p/k}} = \frac{s}{4}\sqrt{\frac{k}{p}}$$

where we assume $s \geq 6\sqrt{p/k}$.

How many pairs do we have?

- ▶ there are $k\ell$ blocks in total
- ▶ there are $k \cdot \ell^2$ matrix entries in total
- ▶ there are at least $k \cdot \ell^2 - p$ zeros.
- ▶ choosing a random diagonal (same for every matrix M^i) hits at least

$$\frac{k\ell^2 - p}{2\ell - 1} \geq \frac{k\ell}{2} - \frac{p}{2\ell}$$

zeroes.

- ▶ Choosing $\ell = \lceil 2\sqrt{p/k} \rceil$ gives

$$k' \geq \frac{3}{4}\sqrt{pk} \text{ and } s' = \lfloor \frac{s}{\ell} \rfloor \geq \frac{s}{4\sqrt{p/k}} = \frac{s}{4}\sqrt{\frac{k}{p}}$$

where we assume $s \geq 6\sqrt{p/k}$.

How many pairs do we have?

- ▶ there are $k\ell$ blocks in total
- ▶ there are $k \cdot \ell^2$ matrix entries in total
- ▶ there are at least $k \cdot \ell^2 - p$ zeros.
- ▶ choosing a random diagonal (same for every matrix M^i) hits at least

$$\frac{k\ell^2 - p}{2\ell - 1} \geq \frac{k\ell}{2} - \frac{p}{2\ell}$$

zeroes.

- ▶ Choosing $\ell = \lceil 2\sqrt{p/k} \rceil$ gives

$$k' \geq \frac{3}{4}\sqrt{pk} \text{ and } s' = \lfloor \frac{s}{\ell} \rfloor \geq \frac{s}{4\sqrt{p/k}} = \frac{s}{4}\sqrt{\frac{k}{p}}$$

where we assume $s \geq 6\sqrt{p/k}$.

How many pairs do we have?

- ▶ there are $k\ell$ blocks in total
- ▶ there are $k \cdot \ell^2$ matrix entries in total
- ▶ there are at least $k \cdot \ell^2 - p$ zeros.
- ▶ choosing a random diagonal (same for every matrix M^i) hits at least

$$\frac{k\ell^2 - p}{2\ell - 1} \geq \frac{k\ell}{2} - \frac{p}{2\ell}$$

zeroes.

- ▶ Choosing $\ell = \lceil 2\sqrt{p/k} \rceil$ gives

$$k' \geq \frac{3}{4}\sqrt{pk} \text{ and } s' = \lfloor \frac{s}{\ell} \rfloor \geq \frac{s}{4\sqrt{p/k}} = \frac{s}{4}\sqrt{\frac{k}{p}}$$

where we assume $s \geq 6\sqrt{p/k}$.

How many pairs do we have?

- ▶ there are $k\ell$ blocks in total
- ▶ there are $k \cdot \ell^2$ matrix entries in total
- ▶ there are at least $k \cdot \ell^2 - p$ zeros.
- ▶ choosing a random diagonal (same for every matrix M^i) hits at least

$$\frac{k\ell^2 - p}{2\ell - 1} \geq \frac{k\ell}{2} - \frac{p}{2\ell}$$

zeroes.

- ▶ Choosing $\ell = \lceil 2\sqrt{p/k} \rceil$ gives

$$k' \geq \frac{3}{4}\sqrt{pk} \text{ and } s' = \lfloor \frac{s}{\ell} \rfloor \geq \frac{s}{4\sqrt{p/k}} = \frac{s}{4}\sqrt{\frac{k}{p}}$$

where we assume $s \geq 6\sqrt{p/k}$.

Lemma 36

Let $T(k, s, p)$ be the number of parallel steps required on a comparison tree to solve the (k, s) merging problem. Then

$$T(k, p, s) \geq \frac{1}{4} \log \frac{\log \frac{p}{k}}{\log \frac{p}{ks}}$$

provided that $p \geq 2ks$ and $p \leq ks^2/36$

Induction Step:

Assume that

$$T(k', s', p) \geq \frac{1}{4} \log \frac{\log \frac{p}{k'}}{\log \frac{p}{k' s'}}$$

Induction Step:

Assume that

$$\begin{aligned} T(k', s', p) &\geq \frac{1}{4} \log \frac{\log \frac{p}{k'}}{\log \frac{p}{k' s'}} \\ &\geq \frac{1}{4} \log \frac{\log \frac{4}{3} \sqrt{\frac{p}{k}}}{\log \frac{16}{3} \frac{p}{ks}} \end{aligned}$$

Induction Step:

Assume that

$$\begin{aligned}T(k', s', p) &\geq \frac{1}{4} \log \frac{\log \frac{p}{k'}}{\log \frac{p}{k' s'}} \\ &\geq \frac{1}{4} \log \frac{\log \frac{4}{3} \sqrt{\frac{p}{k}}}{\log \frac{16}{3} \frac{p}{k s}} \\ &\geq \frac{1}{4} \log \frac{\frac{1}{2} \log \frac{p}{k}}{7 \log \frac{p}{k s}}\end{aligned}$$

Induction Step:

Assume that

$$\begin{aligned}T(k', s', p) &\geq \frac{1}{4} \log \frac{\log \frac{p}{k'}}{\log \frac{p}{k's'}} \\ &\geq \frac{1}{4} \log \frac{\log \frac{4}{3} \sqrt{\frac{p}{k}}}{\log \frac{16}{3} \frac{p}{ks}} \\ &\geq \frac{1}{4} \log \frac{\frac{1}{2} \log \frac{p}{k}}{7 \log \frac{p}{ks}} \\ &\geq \frac{1}{4} \log \frac{\log \frac{p}{k}}{\log \frac{p}{ks}} - 1\end{aligned}$$

Induction Step:

Assume that

$$\begin{aligned}T(k', s', p) &\geq \frac{1}{4} \log \frac{\log \frac{p}{k'}}{\log \frac{p}{k's'}} \\ &\geq \frac{1}{4} \log \frac{\log \frac{4}{3} \sqrt{\frac{p}{k}}}{\log \frac{16}{3} \frac{p}{ks}} \\ &\geq \frac{1}{4} \log \frac{\frac{1}{2} \log \frac{p}{k}}{7 \log \frac{p}{ks}} \\ &\geq \frac{1}{4} \log \frac{\log \frac{p}{k}}{\log \frac{p}{ks}} - 1\end{aligned}$$

This gives the induction step.

Theorem 37

Merging requires at least $\Omega(\log \log n)$ time on a CRCW PRAM with n processors.

Simulations between PRAMs

Theorem 38

We can simulate a p -processor priority CRCW PRAM on a p -processor EREW PRAM with slowdown $\mathcal{O}(\log p)$.

Simulations between PRAMs

Theorem 39

We can simulate a p -processor priority CRCW PRAM on a $p \log p$ -processor common CRCW PRAM with slowdown $\mathcal{O}(1)$.

Simulations between PRAMs

Theorem 40

We can simulate a p -processor priority CRCW PRAM on a p -processor common CRCW PRAM with slowdown $\mathcal{O}\left(\frac{\log p}{\log \log p}\right)$.

Simulations between PRAMs

Theorem 41

We can simulate a p -processor priority CRCW PRAM on a p -processor arbitrary CRCW PRAM with slowdown $\mathcal{O}(\log \log p)$.

Lower Bounds for the CREW PRAM

Ideal PRAM:

- ▶ every processor has unbounded local memory
- ▶ in each step a processor reads a global variable
- ▶ then it does some (unbounded) computation on its local memory
- ▶ then it writes a global variable

Lower Bounds for the CREW PRAM

Ideal PRAM:

- ▶ every processor has unbounded local memory
- ▶ in each step a processor reads a global variable
- ▶ then it does some (unbounded) computation on its local memory
- ▶ then it writes a global variable

Lower Bounds for the CREW PRAM

Ideal PRAM:

- ▶ every processor has unbounded local memory
- ▶ in each step a processor reads a global variable
- ▶ then it does some (**unbounded**) computation on its local memory
- ▶ then it writes a global variable

Lower Bounds for the CREW PRAM

Ideal PRAM:

- ▶ every processor has unbounded local memory
- ▶ in each step a processor reads a global variable
- ▶ then it does some (**unbounded**) computation on its local memory
- ▶ then it writes a global variable

Lower Bounds for the CREW PRAM

Definition 42

An input index i **affects a memory location M** at time t on some input I if the content of M at time t differs between inputs I and $I(i)$ (i -th bit flipped).

$$L(M, t, I) = \{i \mid i \text{ affects } M \text{ at time } t \text{ on input } I\}$$

Lower Bounds for the CREW PRAM

Definition 42

An input index i **affects a memory location M** at time t on some input I if the content of M at time t differs between inputs I and $I(i)$ (i -th bit flipped).

$$L(M, t, I) = \{i \mid i \text{ affects } M \text{ at time } t \text{ on input } I\}$$

Lower Bounds for the CREW PRAM

Definition 43

An input index i **affects a processor P** at time t on some input I if the state of P at time t differs between inputs I and $I(i)$ (i -th bit flipped).

$$K(P, t, I) = \{i \mid i \text{ affects } P \text{ at time } t \text{ on input } I\}$$

Lower Bounds for the CREW PRAM

Definition 43

An input index i **affects a processor** P at time t on some input I if the state of P at time t differs between inputs I and $I(i)$ (i -th bit flipped).

$$K(P, t, I) = \{i \mid i \text{ affects } P \text{ at time } t \text{ on input } I\}$$

Lower Bounds for the CREW PRAM

Lemma 44

If $i \in K(P, t, I)$ with $t > 1$ then either

- ▶ $i \in K(P, t - 1, I)$, or*
- ▶ P reads a global memory location M on input I at time t , and $i \in L(M, t - 1, I)$.*

Lower Bounds for the CREW PRAM

Lemma 45

If $i \in L(M, t, I)$ with $t > 1$ then either

- ▶ *A processor writes into M at time t on input I and $i \in K(P, t, I)$, or*
- ▶ *No processor writes into M at time t on input I and
 - ▶ *either $i \in L(M, t - 1, I)$*
 - ▶ *or a processor P writes into M at time t on input $I(i)$.**

Let $k_0 = 0, \ell_0 = 1$ and define

$$k_{t+1} = k_t + \ell_t \text{ and } \ell_{t+1} = 3k_t + 4\ell_t$$

Lemma 46

$|K(P, t, I)| \leq k_t$ and $|L(M, t, I)| \leq \ell_t$ for any $t \geq 0$

Let $k_0 = 0, \ell_0 = 1$ and define

$$k_{t+1} = k_t + \ell_t \text{ and } \ell_{t+1} = 3k_t + 4\ell_t$$

Lemma 46

$|K(P, t, I)| \leq k_t$ and $|L(M, t, I)| \leq \ell_t$ for any $t \geq 0$

base case ($t = 0$):

- ▶ No index can influence the local memory/state of a processor before the first step (hence $|K(P, 0, I)| = k_0 = 0$).
- ▶ Initially every index in the input affects exactly one memory location. Hence $|L(M, 0, I)| = 1 = \ell_0$.

base case ($t = 0$):

- ▶ No index can influence the local memory/state of a processor before the first step (hence $|K(P, 0, I)| = k_0 = 0$).
- ▶ Initially every index in the input affects exactly one memory location. Hence $|L(M, 0, I)| = 1 = \ell_0$.

induction step ($t \rightarrow t + 1$):

$K(P, t + 1, I) \subseteq K(P, t, I) \cup L(M, t, I)$, where M is the location read by P in step $t + 1$.

induction step ($t \rightarrow t + 1$):

$K(P, t + 1, I) \subseteq K(P, t, I) \cup L(M, t, I)$, where M is the location read by P in step $t + 1$.

Hence,

$$|K(P, t + 1, I)|$$

induction step ($t \rightarrow t + 1$):

$K(P, t + 1, I) \subseteq K(P, t, I) \cup L(M, t, I)$, where M is the location read by P in step $t + 1$.

Hence,

$$|K(P, t + 1, I)| \leq |K(P, t, I)| + |L(M, t, I)|$$

induction step ($t \rightarrow t + 1$):

$K(P, t + 1, I) \subseteq K(P, t, I) \cup L(M, t, I)$, where M is the location read by P in step $t + 1$.

Hence,

$$\begin{aligned} |K(P, t + 1, I)| &\leq |K(P, t, I)| + |L(M, t, I)| \\ &\leq k_t + \ell_t \end{aligned}$$

induction step ($t \rightarrow t + 1$):

For the bound on $|L(M, t + 1, I)|$ we have two cases.

induction step ($t \rightarrow t + 1$):

For the bound on $|L(M, t + 1, I)|$ we have two cases.

Case 1:

A processor P writes into location M at time $t + 1$ on input I .

induction step ($t \rightarrow t + 1$):

For the bound on $|L(M, t + 1, I)|$ we have two cases.

Case 1:

A processor P writes into location M at time $t + 1$ on input I .

Then,

$$|L(M, t + 1, I)|$$

induction step ($t \rightarrow t + 1$):

For the bound on $|L(M, t + 1, I)|$ we have two cases.

Case 1:

A processor P writes into location M at time $t + 1$ on input I .

Then,

$$|L(M, t + 1, I)| \leq |K(P, t + 1, I)|$$

induction step ($t \rightarrow t + 1$):

For the bound on $|L(M, t + 1, I)|$ we have two cases.

Case 1:

A processor P writes into location M at time $t + 1$ on input I .

Then,

$$\begin{aligned} |L(M, t + 1, I)| &\leq |K(P, t + 1, I)| \\ &\leq k_t + \ell_t \end{aligned}$$

induction step ($t \rightarrow t + 1$):

For the bound on $|L(M, t + 1, I)|$ we have two cases.

Case 1:

A processor P writes into location M at time $t + 1$ on input I .

Then,

$$\begin{aligned} |L(M, t + 1, I)| &\leq |K(P, t + 1, I)| \\ &\leq k_t + \ell_t \\ &\leq 3k_t + 4\ell_t = \ell_{t+1} \end{aligned}$$

Case 2:

No processor P writes into location M at time $t + 1$ on input I .

Case 2:

No processor P writes into location M at time $t + 1$ on input I .

An index i affects M at time $t + 1$ iff i affects M at time t or some processor P writes into M at $t + 1$ on $I(i)$.

Case 2:

No processor P writes into location M at time $t + 1$ on input I .

An index i affects M at time $t + 1$ iff i affects M at time t or some processor P writes into M at $t + 1$ on $I(i)$.

$$L(M, t + 1, I) \subseteq L(M, t, I) \cup Y(M, t + 1, I)$$

Case 2:

No processor P writes into location M at time $t + 1$ on input I .

An index i affects M at time $t + 1$ iff i affects M at time t or some processor P writes into M at $t + 1$ on $I(i)$.

$$L(M, t + 1, I) \subseteq L(M, t, I) \cup Y(M, t + 1, I)$$

$Y(M, t + 1, I)$ is the set of indices u_j that cause some processor P_{w_j} to write into M at time $t + 1$ on input I .

$Y(M, t + 1, I)$ is the set of indices u_j that cause some processor P_{w_j} to write into M at time $t + 1$ on input I .

$Y(M, t + 1, I)$ is the set of indices u_j that cause some processor P_{w_j} to write into M at time $t + 1$ on input I .

Fact:

For all pairs u_s, u_t with $P_{w_s} \neq P_{w_t}$ either $u_s \in K(P_{w_t}, t + 1, I(u_t))$ or $u_t \in K(P_{w_s}, t + 1, I(u_s))$.

$Y(M, t + 1, I)$ is the set of indices u_j that cause some processor P_{w_j} to write into M at time $t + 1$ on input I .

Fact:

For all pairs u_s, u_t with $P_{w_s} \neq P_{w_t}$ either $u_s \in K(P_{w_t}, t + 1, I(u_t))$ or $u_t \in K(P_{w_s}, t + 1, I(u_s))$.

Otherwise, P_{w_t} and P_{w_s} would both write into M at the same time on input $I(u_s)(u_t)$.

Let $U = \{u_1, \dots, u_r\}$ denote all indices that cause some processor to write into M .

Let $U = \{u_1, \dots, u_r\}$ denote all indices that cause some processor to write into M .

Let $V = \{(I(u_1), P_{w_1}), \dots\}$.

Let $U = \{u_1, \dots, u_r\}$ denote all indices that cause some processor to write into M .

Let $V = \{(I(u_1), P_{w_1}), \dots\}$.

We set up a bipartite graph between U and V , such that $(u_i, (I(u_j), P_{w_j})) \in E$ if u_i affects P_{w_j} at time $t + 1$ on input $I(u_j)$.

Let $U = \{u_1, \dots, u_r\}$ denote all indices that cause some processor to write into M .

Let $V = \{(I(u_1), P_{w_1}), \dots\}$.

We set up a bipartite graph between U and V , such that $(u_i, (I(u_j), P_{w_j})) \in E$ if u_i affects P_{w_j} at time $t + 1$ on input $I(u_j)$.

Each vertex $(I(u_j), P_{w_j})$ has degree at most k_{t+1} as this is an upper bound on indices that can influence a processor P_{w_j} .

Let $U = \{u_1, \dots, u_r\}$ denote all indices that cause some processor to write into M .

Let $V = \{(I(u_1), P_{w_1}), \dots\}$.

We set up a bipartite graph between U and V , such that $(u_i, (I(u_j), P_{w_j})) \in E$ if u_i affects P_{w_j} at time $t + 1$ on input $I(u_j)$.

Each vertex $(I(u_j), P_{w_j})$ has degree at most k_{t+1} as this is an upper bound on indices that can influence a processor P_{w_j} .

Hence, $|E| \leq r \cdot k_{t+1}$.

For an index u_j there can be at most k_{t+1} indices u_i with $P_{w_i} = P_{w_j}$.

Hence, there must be at least $\frac{1}{2}r(r - k_{t+1})$ pairs u_i, u_j with $P_{w_i} \neq P_{w_j}$.

Each pair introduces at least one edge.

Hence,

$$|E| \geq \frac{1}{2}r(r - k_{t+1})$$

This gives $r \leq 3k_{t+1} \leq 3k_t + 3\ell_t$

For an index u_j there can be at most k_{t+1} indices u_i with $P_{w_i} = P_{w_j}$.

Hence, there must be at least $\frac{1}{2}r(r - k_{t+1})$ pairs u_i, u_j with $P_{w_i} \neq P_{w_j}$.

Each pair introduces at least one edge.

Hence,

$$|E| \geq \frac{1}{2}r(r - k_{t+1})$$

This gives $r \leq 3k_{t+1} \leq 3k_t + 3\ell_t$

For an index u_j there can be at most k_{t+1} indices u_i with $P_{w_i} = P_{w_j}$.

Hence, there must be at least $\frac{1}{2}r(r - k_{t+1})$ pairs u_i, u_j with $P_{w_i} \neq P_{w_j}$.

Each pair introduces at least one edge.

Hence,

$$|E| \geq \frac{1}{2}r(r - k_{t+1})$$

This gives $r \leq 3k_{t+1} \leq 3k_t + 3l_t$

For an index u_j there can be at most k_{t+1} indices u_i with $P_{w_i} = P_{w_j}$.

Hence, there must be at least $\frac{1}{2}r(r - k_{t+1})$ pairs u_i, u_j with $P_{w_i} \neq P_{w_j}$.

Each pair introduces at least one edge.

Hence,

$$|E| \geq \frac{1}{2}r(r - k_{t+1})$$

This gives $r \leq 3k_{t+1} \leq 3k_t + 3\ell_t$

For an index u_j there can be at most k_{t+1} indices u_i with $P_{w_i} = P_{w_j}$.

Hence, there must be at least $\frac{1}{2}r(r - k_{t+1})$ pairs u_i, u_j with $P_{w_i} \neq P_{w_j}$.

Each pair introduces at least one edge.

Hence,

$$|E| \geq \frac{1}{2}r(r - k_{t+1})$$

This gives $r \leq 3k_{t+1} \leq 3k_t + 3\ell_t$

Recall that $L(M, t + 1, i) \subseteq L(M, t, i) \cup Y(M, t + 1, I)$

$$|L(M, t + 1, i)| \leq 3k_t + 4\ell_t$$

Recall that $L(M, t + 1, i) \subseteq L(M, t, i) \cup Y(M, t + 1, I)$

$$|L(M, t + 1, i)| \leq 3k_t + 4\ell_t$$

Recall that $L(M, t + 1, i) \subseteq L(M, t, i) \cup Y(M, t + 1, I)$

$$|L(M, t + 1, i)| \leq 3k_t + 4\ell_t$$

$$\begin{pmatrix} k_{t+1} \\ \ell_{t+1} \end{pmatrix} = \begin{pmatrix} 1 & 1 \\ 3 & 4 \end{pmatrix} \begin{pmatrix} k_t \\ \ell_t \end{pmatrix} \quad \begin{pmatrix} k_0 \\ \ell_0 \end{pmatrix} = \begin{pmatrix} 0 \\ 1 \end{pmatrix}$$

Eigenvalues:

$$\lambda_1 = \frac{1}{2}(5 + \sqrt{21}) \text{ and } \lambda_2 = \frac{1}{2}(5 - \sqrt{21})$$

Eigenvectors:

$$v_1 = \begin{pmatrix} 1 \\ -(1 - \lambda_1) \end{pmatrix} \text{ and } v_2 = \begin{pmatrix} 1 \\ -(1 - \lambda_2) \end{pmatrix}$$

$$v_1 = \begin{pmatrix} 1 \\ \frac{3}{2} + \frac{1}{2}\sqrt{21} \end{pmatrix} \text{ and } v_2 = \begin{pmatrix} 1 \\ \frac{3}{2} - \frac{1}{2}\sqrt{21} \end{pmatrix}$$

$$\begin{pmatrix} k_{t+1} \\ \ell_{t+1} \end{pmatrix} = \begin{pmatrix} 1 & 1 \\ 3 & 4 \end{pmatrix} \begin{pmatrix} k_t \\ \ell_t \end{pmatrix} \quad \begin{pmatrix} k_0 \\ \ell_0 \end{pmatrix} = \begin{pmatrix} 0 \\ 1 \end{pmatrix}$$

Eigenvalues:

$$\lambda_1 = \frac{1}{2}(5 + \sqrt{21}) \text{ and } \lambda_2 = \frac{1}{2}(5 - \sqrt{21})$$

Eigenvectors:

$$v_1 = \begin{pmatrix} 1 \\ -(1 - \lambda_1) \end{pmatrix} \text{ and } v_2 = \begin{pmatrix} 1 \\ -(1 - \lambda_2) \end{pmatrix}$$

$$v_1 = \begin{pmatrix} 1 \\ \frac{3}{2} + \frac{1}{2}\sqrt{21} \end{pmatrix} \text{ and } v_2 = \begin{pmatrix} 1 \\ \frac{3}{2} - \frac{1}{2}\sqrt{21} \end{pmatrix}$$

$$\begin{pmatrix} k_{t+1} \\ \ell_{t+1} \end{pmatrix} = \begin{pmatrix} 1 & 1 \\ 3 & 4 \end{pmatrix} \begin{pmatrix} k_t \\ \ell_t \end{pmatrix} \quad \begin{pmatrix} k_0 \\ \ell_0 \end{pmatrix} = \begin{pmatrix} 0 \\ 1 \end{pmatrix}$$

Eigenvalues:

$$\lambda_1 = \frac{1}{2}(5 + \sqrt{21}) \text{ and } \lambda_2 = \frac{1}{2}(5 - \sqrt{21})$$

Eigenvectors:

$$v_1 = \begin{pmatrix} 1 \\ -(1 - \lambda_1) \end{pmatrix} \text{ and } v_2 = \begin{pmatrix} 1 \\ -(1 - \lambda_2) \end{pmatrix}$$

$$v_1 = \begin{pmatrix} 1 \\ \frac{3}{2} + \frac{1}{2}\sqrt{21} \end{pmatrix} \text{ and } v_2 = \begin{pmatrix} 1 \\ \frac{3}{2} - \frac{1}{2}\sqrt{21} \end{pmatrix}$$

$$\begin{pmatrix} k_{t+1} \\ \ell_{t+1} \end{pmatrix} = \begin{pmatrix} 1 & 1 \\ 3 & 4 \end{pmatrix} \begin{pmatrix} k_t \\ \ell_t \end{pmatrix} \quad \begin{pmatrix} k_0 \\ \ell_0 \end{pmatrix} = \begin{pmatrix} 0 \\ 1 \end{pmatrix}$$

Eigenvalues:

$$\lambda_1 = \frac{1}{2}(5 + \sqrt{21}) \text{ and } \lambda_2 = \frac{1}{2}(5 - \sqrt{21})$$

Eigenvectors:

$$v_1 = \begin{pmatrix} 1 \\ -(1 - \lambda_1) \end{pmatrix} \text{ and } v_2 = \begin{pmatrix} 1 \\ -(1 - \lambda_2) \end{pmatrix}$$

$$v_1 = \begin{pmatrix} 1 \\ \frac{3}{2} + \frac{1}{2}\sqrt{21} \end{pmatrix} \text{ and } v_2 = \begin{pmatrix} 1 \\ \frac{3}{2} - \frac{1}{2}\sqrt{21} \end{pmatrix}$$

$$v_1 = \left(\frac{3}{2} + \frac{1}{2}\sqrt{21} \right) \text{ and } v_2 = \left(\frac{3}{2} - \frac{1}{2}\sqrt{21} \right)$$

$$\begin{pmatrix} k_0 \\ \ell_0 \end{pmatrix} = \begin{pmatrix} 0 \\ 1 \end{pmatrix} = \frac{1}{\sqrt{21}}(v_1 - v_2)$$

$$\begin{pmatrix} k_t \\ \ell_t \end{pmatrix} = \frac{1}{\sqrt{21}}(\lambda_1^t v_1 - \lambda_2^t v_2)$$

$$\mathbf{v}_1 = \left(\frac{3}{2} + \frac{1}{2}\sqrt{21} \right) \text{ and } \mathbf{v}_2 = \left(\frac{3}{2} - \frac{1}{2}\sqrt{21} \right)$$

$$\begin{pmatrix} k_0 \\ \ell_0 \end{pmatrix} = \begin{pmatrix} 0 \\ 1 \end{pmatrix} = \frac{1}{\sqrt{21}}(\mathbf{v}_1 - \mathbf{v}_2)$$

$$\begin{pmatrix} k_t \\ \ell_t \end{pmatrix} = \frac{1}{\sqrt{21}}(\lambda_1^t \mathbf{v}_1 - \lambda_2^t \mathbf{v}_2)$$

$$\mathbf{v}_1 = \left(\frac{3}{2} + \frac{1}{2}\sqrt{21} \right) \text{ and } \mathbf{v}_2 = \left(\frac{3}{2} - \frac{1}{2}\sqrt{21} \right)$$

$$\begin{pmatrix} k_0 \\ \ell_0 \end{pmatrix} = \begin{pmatrix} 0 \\ 1 \end{pmatrix} = \frac{1}{\sqrt{21}}(\mathbf{v}_1 - \mathbf{v}_2)$$

$$\begin{pmatrix} k_t \\ \ell_t \end{pmatrix} = \frac{1}{\sqrt{21}}(\lambda_1^t \mathbf{v}_1 - \lambda_2^t \mathbf{v}_2)$$

Solving the recurrence gives

$$k_t = \frac{\lambda_1^t}{\sqrt{21}} - \frac{\lambda_2^t}{\sqrt{21}}$$

$$\ell_t = \frac{3 + \sqrt{21}}{2\sqrt{21}} \lambda_1^t + \frac{-3 + \sqrt{21}}{2\sqrt{21}} \lambda_2^t$$

with $\lambda_1 = \frac{1}{2}(5 + \sqrt{21})$ and $\lambda_2 = \frac{1}{2}(5 - \sqrt{21})$.

Theorem 47

The following problems require logarithmic time on a CREW PRAM.

- ▶ *Sorting a sequence of x_1, \dots, x_n with $x_i \in \{0, 1\}$*
- ▶ *Computing the maximum of n inputs*
- ▶ *Computing the sum $x_1 + \dots + x_n$ with $x_i \in \{0, 1\}$*

A Lower Bound for the EREW PRAM

Definition 48 (Zero Counting Problem)

Given a monotone binary sequence x_1, x_2, \dots, x_n determine the index i such that $x_i = 0$ and $x_{i+1} = 1$.

We show that this problem requires $\Omega(\log n - \log p)$ steps on a p -processor EREW PRAM.

A Lower Bound for the EREW PRAM

Definition 48 (Zero Counting Problem)

Given a monotone binary sequence x_1, x_2, \dots, x_n determine the index i such that $x_i = 0$ and $x_{i+1} = 1$.

We show that this problem requires $\Omega(\log n - \log p)$ steps on a p -processor EREW PRAM.

Let I_i be the input with i zeros folled by $n - i$ ones.

Index i affects processor P at time t if the state in step t is differs between I_{i-1} and I_i .

Index i affects location M at time t if the content of M after step t differs between inputs I_{i-1} and I_i .

Let I_i be the input with i zeros folled by $n - i$ ones.

Index i affects processor P at time t if the state in step t is differs between I_{i-1} and I_i .

Index i affects location M at time t if the content of M after step t differs between inputs I_{i-1} and I_i .

Let I_i be the input with i zeros followed by $n - i$ ones.

Index i affects processor P at time t if the state in step t is differs between I_{i-1} and I_i .

Index i affects location M at time t if the content of M after step t differs between inputs I_{i-1} and I_i .

Lemma 49

If $i \in K(P, t)$ then either

- ▶ *$i \in K(P, t - 1)$, or*
- ▶ *P reads some location M on input I_i (and, hence, also on I_{i-1}) at step t and $i \in L(M, t - 1)$*

Lemma 50

If $i \in L(M, t)$ then either

- ▶ $i \in L(M, t - 1)$, or
- ▶ Some processor P writes M at step t on input I_i and $i \in K(P, t)$.
- ▶ Some processor P writes M at step t on input I_{i-1} and $i \in K(P, t)$.

Define

$$C(t) = \sum_P |K(P, t)| + \sum_M \max\{0, |L(M, t)| - 1\}$$

$$C(T) \geq n, C(0) = 0$$

Claim:

$$C(t) \leq 6C(t-1) + 3|P|$$

This gives $C(T) \leq \frac{6^T - 1}{5} 3|P|$ and hence $T = \Omega(\log n - \log |P|)$.

Define

$$C(t) = \sum_P |K(P, t)| + \sum_M \max\{0, |L(M, t)| - 1\}$$

$$C(T) \geq n, C(0) = 0$$

Claim:

$$C(t) \leq 6C(t-1) + 3|P|$$

This gives $C(T) \leq \frac{6^T - 1}{5} 3|P|$ and hence $T = \Omega(\log n - \log |P|)$.

Define

$$C(t) = \sum_P |K(P, t)| + \sum_M \max\{0, |L(M, t)| - 1\}$$

$$C(T) \geq n, C(0) = 0$$

Claim:

$$C(t) \leq 6C(t-1) + 3|P|$$

This gives $C(T) \leq \frac{6^T - 1}{5} 3|P|$ and hence $T = \Omega(\log n - \log |P|)$.

Define

$$C(t) = \sum_P |K(P, t)| + \sum_M \max\{0, |L(M, t)| - 1\}$$

$$C(T) \geq n, C(0) = 0$$

Claim:

$$C(t) \leq 6C(t-1) + 3|P|$$

This gives $C(T) \leq \frac{6^T - 1}{5} 3|P|$ and hence $T = \Omega(\log n - \log |P|)$.

For an index i to **newly** appear in $L(M, t)$ some processor must write into M on either input I_i or I_{i-1} .

Hence, any index in $K(P, t)$ can at most generate two **new** indices in $L(M, t)$.

This means that the number of new indices in any set $L(M, t)$ (over all M) is at most

$$2 \sum_P |K(P, t)|$$

For an index i to **newly** appear in $L(M, t)$ some processor must write into M on either input I_i or I_{i-1} .

Hence, any index in $K(P, t)$ can at most generate two **new** indices in $L(M, t)$.

This means that the number of new indices in any set $L(M, t)$ (over all M) is at most

$$2 \sum_P |K(P, t)|$$

For an index i to **newly** appear in $L(M, t)$ some processor must write into M on either input I_i or I_{i-1} .

Hence, any index in $K(P, t)$ can at most generate two **new** indices in $L(M, t)$.

This means that the number of new indices in any set $L(M, t)$ (over all M) is at most

$$2 \sum_P |K(P, t)|$$

Hence,

$$\sum_M |L(M, t)| \leq \sum_M |L(M, t - 1)| + 2 \sum_P |K(P, t)|$$

We can assume wlog. that $L(M, t - 1) \subseteq L(M, t)$. Then

$$\sum_M \max\{0, |L(M, t)| - 1\} \leq \sum_M \max\{0, |L(M, t - 1)| - 1\} + 2 \sum_P |K(P, t)|$$

Hence,

$$\sum_M |L(M, t)| \leq \sum_M |L(M, t - 1)| + 2 \sum_P |K(P, t)|$$

We can assume wlog. that $L(M, t - 1) \subseteq L(M, t)$. Then

$$\sum_M \max\{0, |L(M, t)| - 1\} \leq \sum_M \max\{0, |L(M, t - 1)| - 1\} + 2 \sum_P |K(P, t)|$$

Hence,

$$\sum_M |L(M, t)| \leq \sum_M |L(M, t - 1)| + 2 \sum_P |K(P, t)|$$

We can assume wlog. that $L(M, t - 1) \subseteq L(M, t)$. Then

$$\sum_M \max\{0, |L(M, t)| - 1\} \leq \sum_M \max\{0, |L(M, t - 1)| - 1\} + 2 \sum_P |K(P, t)|$$

For an index i to **newly** appear in $K(P, t)$, P must read a memory location M with $i \in L(M, t)$ on input I_i (and also on input I_{i-1}).

Since we are in the EREW model at most one processor can do so in every step.

Let $J(i, t)$ be memory locations read in step t on input I_i , and let $J_t = \bigcup_i J(i, t)$.

$$\sum_P |K(P, t)| \leq \sum_P |K(P, t-1)| + \sum_{M \in J_t} |L(M, t-1)|$$

Over all inputs I_i a processor can read at most $|K(P, t-1)| + 1$ different memory locations (why?).

For an index i to **newly** appear in $K(P, t)$, P must read a memory location M with $i \in L(M, t)$ on input I_i (and also on input I_{i-1}).

Since we are in the EREW model at most one processor can do so in every step.

Let $J(i, t)$ be memory locations read in step t on input I_i , and let $J_t = \bigcup_i J(i, t)$.

$$\sum_P |K(P, t)| \leq \sum_P |K(P, t-1)| + \sum_{M \in J_t} |L(M, t-1)|$$

Over all inputs I_i a processor can read at most $|K(P, t-1)| + 1$ different memory locations (why?).

For an index i to **newly** appear in $K(P, t)$, P must read a memory location M with $i \in L(M, t)$ on input I_i (and also on input I_{i-1}).

Since we are in the EREW model at most one processor can do so in every step.

Let $J(i, t)$ be memory locations read in step t on input I_i , and let $J_t = \bigcup_i J(i, t)$.

$$\sum_P |K(P, t)| \leq \sum_P |K(P, t-1)| + \sum_{M \in J_t} |L(M, t-1)|$$

Over all inputs I_i a processor can read at most $|K(P, t-1)| + 1$ different memory locations (why?).

For an index i to **newly** appear in $K(P, t)$, P must read a memory location M with $i \in L(M, t)$ on input I_i (and also on input I_{i-1}).

Since we are in the EREW model at most one processor can do so in every step.

Let $J(i, t)$ be memory locations read in step t on input I_i , and let $J_t = \bigcup_i J(i, t)$.

$$\sum_P |K(P, t)| \leq \sum_P |K(P, t-1)| + \sum_{M \in J_t} |L(M, t-1)|$$

Over all inputs I_i a processor can read at most $|K(P, t-1)| + 1$ different memory locations (why?).

For an index i to **newly** appear in $K(P, t)$, P must read a memory location M with $i \in L(M, t)$ on input I_i (and also on input I_{i-1}).

Since we are in the EREW model at most one processor can do so in every step.

Let $J(i, t)$ be memory locations read in step t on input I_i , and let $J_t = \bigcup_i J(i, t)$.

$$\sum_P |K(P, t)| \leq \sum_P |K(P, t-1)| + \sum_{M \in J_t} |L(M, t-1)|$$

Over all inputs I_i a processor can read at most $|K(P, t-1)| + 1$ different memory locations (why?).

Hence,

$$\sum_P |K(P, t)|$$

Hence,

$$\sum_P |K(P, t)| \leq \sum_P |K(P, t - 1)| + \sum_{M \in J_t} |L(M, t - 1)|$$

Hence,

$$\begin{aligned}\sum_P |K(P, t)| &\leq \sum_P |K(P, t - 1)| + \sum_{M \in J_t} |L(M, t - 1)| \\ &\leq \sum_P |K(P, t - 1)| + \sum_{M \in J_t} (|L(M, t - 1)| - 1) + J_t\end{aligned}$$

Hence,

$$\begin{aligned}\sum_P |K(P, t)| &\leq \sum_P |K(P, t - 1)| + \sum_{M \in J_t} |L(M, t - 1)| \\ &\leq \sum_P |K(P, t - 1)| + \sum_{M \in J_t} (|L(M, t - 1)| - 1) + J_t \\ &\leq 2 \sum_P |K(P, t - 1)| + \sum_{M \in J_t} (|L(M, t - 1)| - 1) + |P|\end{aligned}$$

Hence,

$$\begin{aligned}\sum_P |K(P, t)| &\leq \sum_P |K(P, t - 1)| + \sum_{M \in J_t} |L(M, t - 1)| \\ &\leq \sum_P |K(P, t - 1)| + \sum_{M \in J_t} (|L(M, t - 1)| - 1) + J_t \\ &\leq 2 \sum_P |K(P, t - 1)| + \sum_{M \in J_t} (|L(M, t - 1)| - 1) + |P| \\ &\leq 2 \sum_P |K(P, t - 1)| + \sum_M \max\{0, |L(M, t - 1)| - 1\} + |P|\end{aligned}$$

Hence,

$$\begin{aligned}\sum_P |K(P, t)| &\leq \sum_P |K(P, t - 1)| + \sum_{M \in J_t} |L(M, t - 1)| \\ &\leq \sum_P |K(P, t - 1)| + \sum_{M \in J_t} (|L(M, t - 1)| - 1) + J_t \\ &\leq 2 \sum_P |K(P, t - 1)| + \sum_{M \in J_t} (|L(M, t - 1)| - 1) + |P| \\ &\leq 2 \sum_P |K(P, t - 1)| + \sum_M \max\{0, |L(M, t - 1)| - 1\} + |P|\end{aligned}$$

Hence,

$$\begin{aligned}\sum_P |K(P, t)| &\leq \sum_P |K(P, t - 1)| + \sum_{M \in J_t} |L(M, t - 1)| \\ &\leq \sum_P |K(P, t - 1)| + \sum_{M \in J_t} (|L(M, t - 1)| - 1) + J_t \\ &\leq 2 \sum_P |K(P, t - 1)| + \sum_{M \in J_t} (|L(M, t - 1)| - 1) + |P| \\ &\leq 2 \sum_P |K(P, t - 1)| + \sum_M \max\{0, |L(M, t - 1)| - 1\} + |P|\end{aligned}$$

Recall

$$\sum_M \max\{0, |L(M, t)| - 1\} \leq \sum_M \max\{0, |L(M, t - 1)| - 1\} + 2 \sum_P |K(P, t)|$$

This gives

$$\begin{aligned} & \sum_P K(P, t) + \sum_M \max\{0, |L(M, t)| - 1\} \\ & \leq 4 \sum_M \max\{0, |L(M, t - 1)| - 1\} + 6 \sum_P |K(P, t - 1)| + 3|P| \end{aligned}$$

Hence,

$$C(t) \leq 6C(t - 1) + 3|P|$$

This gives

$$\begin{aligned} & \sum_P K(P, t) + \sum_M \max\{0, |L(M, t)| - 1\} \\ & \leq 4 \sum_M \max\{0, |L(M, t - 1)| - 1\} + 6 \sum_P |K(P, t - 1)| + 3|P| \end{aligned}$$

Hence,

$$C(t) \leq 6C(t - 1) + 3|P|$$

Lower Bounds for CRCW PRAMS

Theorem 51

Let $f : \{0,1\}^n \rightarrow \{0,1\}$ be an arbitrary Boolean function. f can be computed in $\mathcal{O}(1)$ time on a common CRCW PRAM with $\leq n2^n$ processors.

Can we obtain non-constant lower bounds if we restrict the number of processors to be polynomial?

Boolean Circuits

- ▶ nodes are either **AND**, **OR**, or **NOT** gates or are special **INPUT/OUTPUT** nodes
- ▶ **AND** and **OR** gates have unbounded fan-in (indegree) and unbounded fan-out (outdegree)
- ▶ **NOT** gates have unbounded fan-out
- ▶ **INPUT** nodes have indegree zero; **OUTPUT** nodes have outdegree zero
- ▶ **size** is the number of edges
- ▶ **depth** is the longest path from an input to an output

Theorem 52

Let $f : \{0, 1\}^n \rightarrow \{0, 1\}^m$ be a function with n inputs and $m \leq n$ outputs, and circuit C computes f with depth $D(n)$ and size $S(n)$. Then f can be computed by a common CRCW PRAM in $\mathcal{O}(D(n))$ time using $S(n)$ processors.

Given a family $\{C_n\}$ of circuits we may not be able to compute the corresponding family of functions on a CRCW PRAM.

Definition 53

A family $\{C_n\}$ of circuits is **logspace uniform** if there exists a deterministic Turing machine M s.t

- ▶ M runs in logarithmic space.
- ▶ For all n , M outputs C_n on input 1^n .

Butterfly Network $BF(d)$

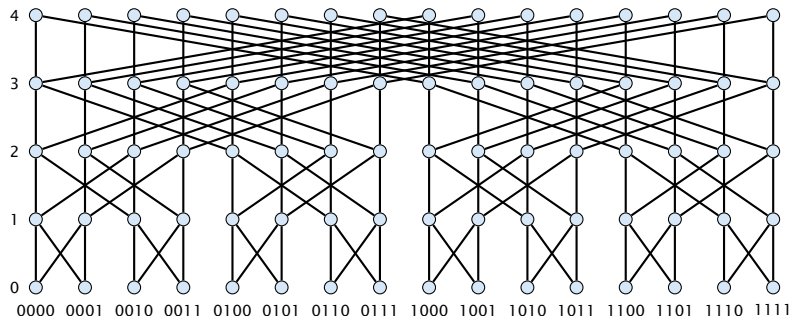

- ▶ node set $V = \{(\ell, \bar{x}) \mid \bar{x} \in [2]^d, \ell \in [d+1]\}$, where $\bar{x} = x_0 x_1 \dots x_{d-1}$ is a bit-string of length d
- ▶ edge set $E = \{(\ell, \bar{x}), (\ell+1, \bar{x}') \mid \ell \in [d], \bar{x} \in [2]^d, x'_i = x_i \text{ for } i \neq \ell\}$

Sometimes the first and last level are identified.

Beneš Network

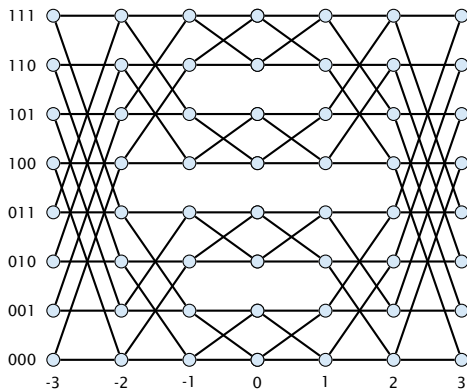

▶ node set $V = \{(\ell, \bar{x}) \mid \bar{x} \in [2]^d, \ell \in \{-d, \dots, d\}\}$

▶ edge set

$$E = \{ \{(\ell, \bar{x}), (\ell + 1, \bar{x}')\} \mid \ell \in [d], \bar{x} \in [2]^d, x'_i = x_i \text{ for } i \neq \ell\} \\ \cup \{ \{(-\ell, \bar{x}), (\ell - 1, \bar{x}')\} \mid \ell \in [d], \bar{x} \in [2]^d, x'_i = x_i \text{ for } i \neq \ell\} \}$$

n -ary Butterfly Network $BF(n, d)$

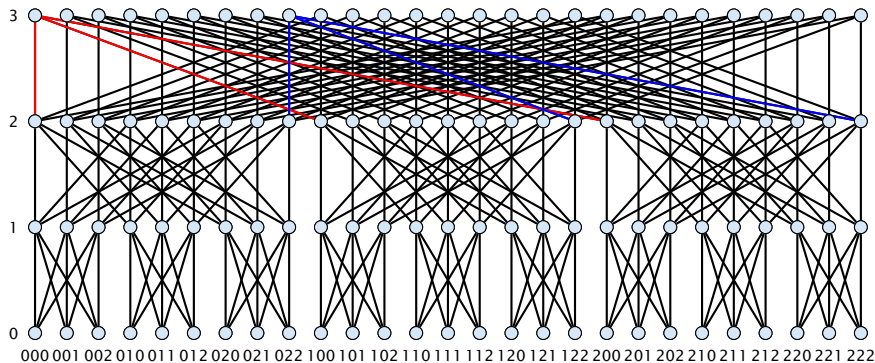

- ▶ node set $V = \{(\ell, \bar{x}) \mid \bar{x} \in [n]^d, \ell \in [d+1]\}$, where $\bar{x} = x_0 x_1 \dots x_{d-1}$ is a bit-string of length d
- ▶ edge set $E = \{ \{(\ell, \bar{x}), (\ell + 1, \bar{x}')\} \mid \ell \in [d], \bar{x} \in [n]^d, x'_i = x_i \text{ for } i \neq \ell \}$

Permutation Network $PN(n, d)$

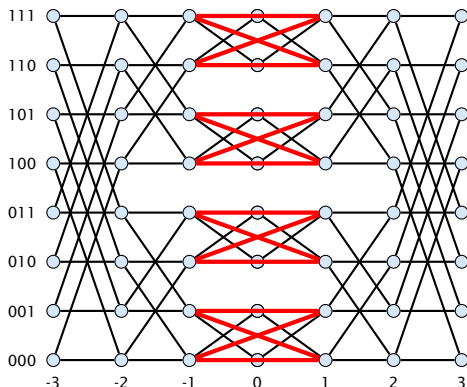

- ▶ There is an n -ary version of the Benes network (2 n -ary butterflies glued at level 0).
- ▶ identifying levels 0 and 1 (or 0 and -1) gives $PN(n, d)$.

The d -dimensional mesh $M(n, d)$

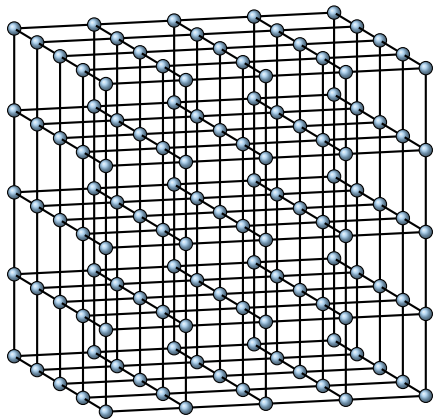

- ▶ node set $V = [n]^d$
- ▶ edge set $E = \{ \{(x_0, \dots, x_i, \dots, x_{d-1}), (x_0, \dots, x_i + 1, \dots, x_{d-1})\} \mid x_s \in [n] \text{ for } s \in [d] \setminus \{i\}, x_i \in [n - 1] \}$

Remarks

$M(2, d)$ is also called d -dimensional hypercube.

$M(n, 1)$ is also called linear array of length n .

Permutation Routing

Lemma 54

On the linear array $M(n, 1)$ any permutation can be routed online in $2n$ steps with buffersize 3.

Permutation Routing

Lemma 55

On the Beneš network any permutation can be routed offline in $2d$ steps between the sources level $(+d)$ and target level $(-d)$.

Recursive Beneš Network

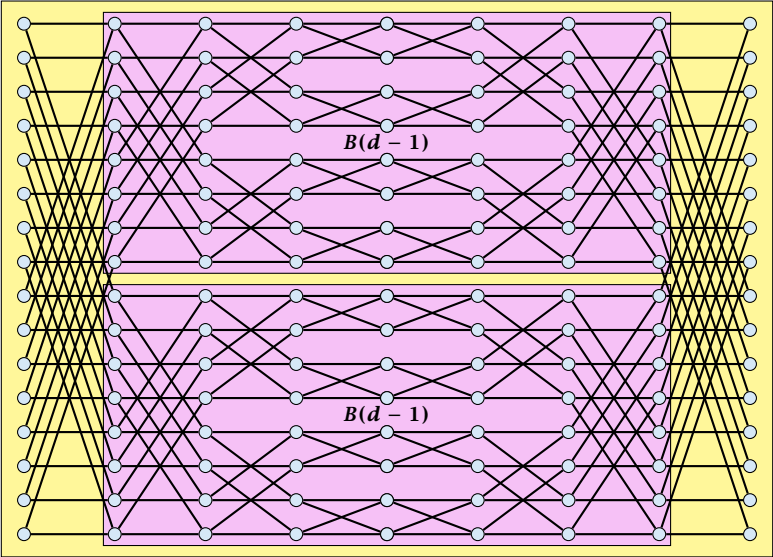

Permutation Routing

base case $d = 0$

trivial

induction step $d \rightarrow d + 1$

The packets that start at (s, d) and $(t(d), d)$ have to be sent into different sub-networks.

The packets that end at $(s, -d)$ and $(t(d), -d)$ have to come out of different sub-networks.

We can generate a graph on the set of packets.

Every packet has an incident source edge (connecting it to the conflicting start packet)

Every packet has an incident target edge (connecting it to the conflicting packet at its target)

This clearly gives a bipartite graph. Coloring this graph tells us which packet to send into which sub-network.

Permutation Routing

base case $d = 0$

trivial

induction step $d \rightarrow d + 1$

The packets that start at (s, d) and $(t(d), d)$ have to be sent into different sub-networks.

The packets that end at $(s, -d)$ and $(t(-d), -d)$ have to come out of different sub-networks.

We can generate a graph on the set of packets.

Every packet has an incident source edge (connecting it to the conflicting start packet)

Every packet has an incident target edge (connecting it to the conflicting packet at its target)

This clearly gives a bipartite graph. Coloring this graph is equivalent to finding a packet to send into which sub-network.

Permutation Routing

base case $d = 0$

trivial

induction step $d \rightarrow d + 1$

- ▶ The packets that start at (\bar{a}, d) and $(\bar{a}(d), d)$ have to be sent into different sub-networks.
- ▶ The packets that end at $(\bar{a}, -d)$ and $(\bar{a}(d), -d)$ have to come out of different sub-networks.

We can generate a graph on the set of packets.

Every packet has an incident source edge (connecting it to the originating packet) or is the originating packet.

Every packet has an incident target edge (connecting it to the originating packet) or is the originating packet.

The graph is bipartite. Call the packets on the left L and the packets on the right R .

Permutation Routing

base case $d = 0$

trivial

induction step $d \rightarrow d + 1$

- ▶ The packets that start at (\bar{a}, d) and $(\bar{a}(d), d)$ have to be sent into different sub-networks.
- ▶ The packets that end at $(\bar{a}, -d)$ and $(\bar{a}(d), -d)$ have to come out of different sub-networks.

We can generate a graph on the set of packets.

Permutation Routing

base case $d = 0$

trivial

induction step $d \rightarrow d + 1$

- ▶ The packets that start at (\bar{a}, d) and $(\bar{a}(d), d)$ have to be sent into different sub-networks.
- ▶ The packets that end at $(\bar{a}, -d)$ and $(\bar{a}(d), -d)$ have to come out of different sub-networks.

We can generate a graph on the set of packets.

- ▶ Every packet has an incident source edge (connecting it to the conflicting start packet)
- ▶ Every packet has an incident target edge (connecting it to the conflicting packet at its target)
- ▶ This clearly gives a bipartite graph; Coloring this graph tells us which packet to send into which sub-network.

Permutation Routing

base case $d = 0$

trivial

induction step $d \rightarrow d + 1$

- ▶ The packets that start at (\bar{a}, d) and $(\bar{a}(d), d)$ have to be sent into different sub-networks.
- ▶ The packets that end at $(\bar{a}, -d)$ and $(\bar{a}(d), -d)$ have to come out of different sub-networks.

We can generate a graph on the set of packets.

- ▶ Every packet has an incident source edge (connecting it to the conflicting start packet)
- ▶ Every packet has an incident target edge (connecting it to the conflicting packet at its target)
- ▶ This clearly gives a bipartite graph; Coloring this graph tells us which packet to send into which sub-network.

Permutation Routing

base case $d = 0$

trivial

induction step $d \rightarrow d + 1$

- ▶ The packets that start at (\bar{a}, d) and $(\bar{a}(d), d)$ have to be sent into different sub-networks.
- ▶ The packets that end at $(\bar{a}, -d)$ and $(\bar{a}(d), -d)$ have to come out of different sub-networks.

We can generate a graph on the set of packets.

- ▶ Every packet has an incident source edge (connecting it to the conflicting start packet)
- ▶ Every packet has an incident target edge (connecting it to the conflicting packet at its target)
- ▶ This clearly gives a bipartite graph; Coloring this graph tells us which packet to send into which sub-network.

Permutation Routing on the n -ary Beneš Network

Instead of two we have n sub-networks $B(n, d - 1)$.

All packets starting at positions

$\{(x_0, \dots, x_{d-2}, x_{d-1}, d) \mid x_{d-1} \in [n]\}$ have to be sent to different sub-networks.

All packets ending at positions

$\{(x_0, \dots, x_{d-2}, x_{d-1}, d) \mid x_{d-1} \in [n]\}$ have to come from different sub-networks.

The conflict graph is an n -uniform 2-regular hypergraph.

We can color such a graph with n colors such that no two nodes in a hyperedge share a color.

This gives the routing.

Permutation Routing on the n -ary Beneš Network

Instead of two we have n sub-networks $B(n, d - 1)$.

All packets starting at positions

$\{(x_0, \dots, x_{d-2}, x_{d-1}, d) \mid x_{d-1} \in [n]\}$ have to be sent to different sub-networks.

All packets ending at positions

$\{(x_0, \dots, x_{d-2}, x_{d-1}, d) \mid x_{d-1} \in [n]\}$ have to come from different sub-networks.

The conflict graph is an n -uniform 2-regular hypergraph.

We can color such a graph with n colors such that no two nodes in a hyperedge share a color.

This gives the routing.

Permutation Routing on the n -ary Beneš Network

Instead of two we have n sub-networks $B(n, d - 1)$.

All packets starting at positions

$\{(x_0, \dots, x_{d-2}, x_{d-1}, d) \mid x_{d-1} \in [n]\}$ have to be sent to different sub-networks.

All packets ending at positions

$\{(x_0, \dots, x_{d-2}, x_{d-1}, d) \mid x_{d-1} \in [n]\}$ have to come from different sub-networks.

The conflict graph is an n -uniform 2-regular hypergraph.

We can color such a graph with n colors such that no two nodes in a hyperedge share a color.

This gives the routing.

Permutation Routing on the n -ary Beneš Network

Instead of two we have n sub-networks $B(n, d - 1)$.

All packets starting at positions

$\{(x_0, \dots, x_{d-2}, x_{d-1}, d) \mid x_{d-1} \in [n]\}$ have to be sent to different sub-networks.

All packets ending at positions

$\{(x_0, \dots, x_{d-2}, x_{d-1}, d) \mid x_{d-1} \in [n]\}$ have to come from different sub-networks.

The conflict graph is an n -uniform 2-regular hypergraph.

We can color such a graph with n colors such that no two nodes in a hyperedge share a color.

This gives the routing.

Permutation Routing on the n -ary Beneš Network

Instead of two we have n sub-networks $B(n, d - 1)$.

All packets starting at positions

$\{(x_0, \dots, x_{d-2}, x_{d-1}, d) \mid x_{d-1} \in [n]\}$ have to be sent to different sub-networks.

All packets ending at positions

$\{(x_0, \dots, x_{d-2}, x_{d-1}, d) \mid x_{d-1} \in [n]\}$ have to come from different sub-networks.

The conflict graph is an n -uniform 2-regular hypergraph.

We can color such a graph with n colors such that no two nodes in a hyperedge share a color.

This gives the routing.

Permutation Routing on the n -ary Beneš Network

Instead of two we have n sub-networks $B(n, d - 1)$.

All packets starting at positions

$\{(x_0, \dots, x_{d-2}, x_{d-1}, d) \mid x_{d-1} \in [n]\}$ have to be sent to different sub-networks.

All packets ending at positions

$\{(x_0, \dots, x_{d-2}, x_{d-1}, d) \mid x_{d-1} \in [n]\}$ have to come from different sub-networks.

The conflict graph is an n -uniform 2-regular hypergraph.

We can color such a graph with n colors such that no two nodes in a hyperedge share a color.

This gives the routing.

Permutation Routing on the n -ary Beneš Network

Instead of two we have n sub-networks $B(n, d - 1)$.

All packets starting at positions

$\{(x_0, \dots, x_{d-2}, x_{d-1}, d) \mid x_{d-1} \in [n]\}$ have to be sent to different sub-networks.

All packets ending at positions

$\{(x_0, \dots, x_{d-2}, x_{d-1}, d) \mid x_{d-1} \in [n]\}$ have to come from different sub-networks.

The conflict graph is an n -uniform 2-regular hypergraph.

We can color such a graph with n colors such that no two nodes in a hyperedge share a color.

This gives the routing.

Lemma 56

On a d -dimensional mesh with sidelength n we can route any permutation (offline) in $4dn$ steps.

We can simulate the algorithm for the n -ary Beneš Network.

Each step can be simulated by routing on disjoint linear arrays.
This takes at most $2n$ steps.

We can simulate the algorithm for the n -ary Beneš Network.

Each step can be simulated by routing on disjoint linear arrays.
This takes at most $2n$ steps.

We simulate the behaviour of the Beneš network on the n -dimensional mesh.

In round $r \in \{-d, \dots, -1, 0, 1, \dots, d-1\}$ we simulate the step of sending from level r of the Beneš network to level $r+1$.

Each node $\tilde{x} \in [n]^d$ of the mesh simulates the node (r, \tilde{x}) .

Hence, if in the Beneš network we send from (r, \tilde{x}) to $(r+1, \tilde{x}')$ we have to send from \tilde{x} to \tilde{x}' in the mesh.

All communication is performed along linear arrays. In round $r < 0$ the linear arrays along dimension $-r-1$ (recall that dimensions are numbered from 0 to $d-1$) are used

$$\tilde{x}_{d-1} \dots \tilde{x}_{-r} \alpha \tilde{x}_{-r-2} \dots \tilde{x}_0$$

In rounds $r \geq 0$ linear arrays along dimension r are used.

Hence, we can perform a round in $\mathcal{O}(n)$ steps.

We simulate the behaviour of the Beneš network on the n -dimensional mesh.

In round $r \in \{-d, \dots, -1, 0, 1, \dots, d-1\}$ we simulate the step of sending from level r of the Beneš network to level $r+1$.

Each node $\tilde{x} \in [n]^d$ of the mesh simulates the node (r, \tilde{x}) .

Hence, if in the Beneš network we send from (r, \tilde{x}) to $(r+1, \tilde{x}')$ we have to send from \tilde{x} to \tilde{x}' in the mesh.

All communication is performed along linear arrays. In round $r < 0$ the linear arrays along dimension $-r-1$ (recall that dimensions are numbered from 0 to $d-1$) are used

$$\tilde{x}_{d-1} \dots \tilde{x}_{-r} \alpha \tilde{x}_{-r-2} \dots \tilde{x}_0$$

In rounds $r \geq 0$ linear arrays along dimension r are used.

Hence, we can perform a round in $\mathcal{O}(n)$ steps.

We simulate the behaviour of the Beneš network on the n -dimensional mesh.

In round $r \in \{-d, \dots, -1, 0, 1, \dots, d-1\}$ we simulate the step of sending from level r of the Beneš network to level $r+1$.

Each node $\tilde{x} \in [n]^d$ of the mesh simulates the node (r, \tilde{x}) .

Hence, if in the Beneš network we send from (r, \tilde{x}) to $(r+1, \tilde{x}')$ we have to send from \tilde{x} to \tilde{x}' in the mesh.

All communication is performed along linear arrays. In round $r < 0$ the linear arrays along dimension $-r-1$ (recall that dimensions are numbered from 0 to $d-1$) are used

$$\tilde{x}_{d-1} \dots \tilde{x}_{-r} \alpha \tilde{x}_{-r-2} \dots \tilde{x}_0$$

In rounds $r \geq 0$ linear arrays along dimension r are used.

Hence, we can perform a round in $\mathcal{O}(n)$ steps.

We simulate the behaviour of the Beneš network on the n -dimensional mesh.

In round $r \in \{-d, \dots, -1, 0, 1, \dots, d-1\}$ we simulate the step of sending from level r of the Beneš network to level $r+1$.

Each node $\tilde{x} \in [n]^d$ of the mesh simulates the node (r, \tilde{x}) .

Hence, if in the Beneš network we send from (r, \tilde{x}) to $(r+1, \tilde{x}')$ we have to send from \tilde{x} to \tilde{x}' in the mesh.

All communication is performed along linear arrays. In round $r < 0$ the linear arrays along dimension $-r-1$ (recall that dimensions are numbered from 0 to $d-1$) are used

$$\tilde{x}_{d-1} \dots \tilde{x}_{-r} \alpha \tilde{x}_{-r-2} \dots \tilde{x}_0$$

In rounds $r \geq 0$ linear arrays along dimension r are used.

Hence, we can perform a round in $\mathcal{O}(n)$ steps.

We simulate the behaviour of the Beneš network on the n -dimensional mesh.

In round $r \in \{-d, \dots, -1, 0, 1, \dots, d-1\}$ we simulate the step of sending from level r of the Beneš network to level $r+1$.

Each node $\tilde{x} \in [n]^d$ of the mesh simulates the node (r, \tilde{x}) .

Hence, if in the Beneš network we send from (r, \tilde{x}) to $(r+1, \tilde{x}')$ we have to send from \tilde{x} to \tilde{x}' in the mesh.

All communication is performed along linear arrays. In round $r < 0$ the linear arrays along dimension $-r-1$ (recall that dimensions are numbered from 0 to $d-1$) are used

$$\tilde{x}_{d-1} \dots \tilde{x}_{-r} \alpha \tilde{x}_{-r-2} \dots \tilde{x}_0$$

In rounds $r \geq 0$ linear arrays along dimension r are used.

Hence, we can perform a round in $\mathcal{O}(n)$ steps.

We simulate the behaviour of the Beneš network on the n -dimensional mesh.

In round $r \in \{-d, \dots, -1, 0, 1, \dots, d-1\}$ we simulate the step of sending from level r of the Beneš network to level $r+1$.

Each node $\tilde{x} \in [n]^d$ of the mesh simulates the node (r, \tilde{x}) .

Hence, if in the Beneš network we send from (r, \tilde{x}) to $(r+1, \tilde{x}')$ we have to send from \tilde{x} to \tilde{x}' in the mesh.

All communication is performed along linear arrays. In round $r < 0$ the linear arrays along dimension $-r-1$ (recall that dimensions are numbered from 0 to $d-1$) are used

$$\tilde{x}_{d-1} \dots \tilde{x}_{-r} \alpha \tilde{x}_{-r-2} \dots \tilde{x}_0$$

In rounds $r \geq 0$ linear arrays along dimension r are used.

Hence, we can perform a round in $\mathcal{O}(n)$ steps.

We simulate the behaviour of the Beneš network on the n -dimensional mesh.

In round $r \in \{-d, \dots, -1, 0, 1, \dots, d-1\}$ we simulate the step of sending from level r of the Beneš network to level $r+1$.

Each node $\tilde{x} \in [n]^d$ of the mesh simulates the node (r, \tilde{x}) .

Hence, if in the Beneš network we send from (r, \tilde{x}) to $(r+1, \tilde{x}')$ we have to send from \tilde{x} to \tilde{x}' in the mesh.

All communication is performed along linear arrays. In round $r < 0$ the linear arrays along dimension $-r-1$ (recall that dimensions are numbered from 0 to $d-1$) are used

$$\tilde{x}_{d-1} \dots \tilde{x}_{-r} \alpha \tilde{x}_{-r-2} \dots \tilde{x}_0$$

In rounds $r \geq 0$ linear arrays along dimension r are used.

Hence, we can perform a round in $\mathcal{O}(n)$ steps.

Lemma 57

We can route any permutation on the Beneš network in $\mathcal{O}(d)$ steps with constant buffer size.

The same is true for the butterfly network.

Lemma 57

We can route any permutation on the Beneš network in $\mathcal{O}(d)$ steps with constant buffer size.

The same is true for the butterfly network.

The nodes are of the form (ℓ, \bar{x}) , $\bar{x} \in [n]^d$, $\ell \in -d, \dots, d$.

We can view nodes with same first coordinate forming columns and nodes with the same second coordinate as forming rows. This gives rows of length $2d - 1$ and columns of length n^d .

We route in 3 phases:

1. Forward packets along the rows such that afterwards no column contains packets that have the same target row. $O(d)$ steps.

2. We can use pipelining to permute every column, so that afterwards every packet is in its target row. $O(2d + 2d)$ steps.

3. Every packet is in its target row. Permute packets to their right destinations. $O(d)$ steps.

The nodes are of the form (ℓ, \bar{x}) , $\bar{x} \in [n]^d$, $\ell \in -d, \dots, d$.

We can view nodes with same first coordinate forming columns and nodes with the same second coordinate as forming rows. This gives rows of length $2d - 1$ and columns of length n^d .

We route in 3 phases:

The nodes are of the form (ℓ, \bar{x}) , $\bar{x} \in [n]^d$, $\ell \in -d, \dots, d$.

We can view nodes with same first coordinate forming columns and nodes with the same second coordinate as forming rows. This gives rows of length $2d - 1$ and columns of length n^d .

We route in 3 phases:

1. Permute packets along the rows such that afterwards no column contains packets that have the same target row. $\mathcal{O}(d)$ steps.
2. We can use pipeling to permute every column, so that afterwards every packet is in its target row. $\mathcal{O}(2d + 2d)$ steps.
3. Every packet is in its target row. Permute packets to their right destinations. $\mathcal{O}(d)$ steps.

The nodes are of the form (ℓ, \bar{x}) , $\bar{x} \in [n]^d$, $\ell \in -d, \dots, d$.

We can view nodes with same first coordinate forming columns and nodes with the same second coordinate as forming rows. This gives rows of length $2d - 1$ and columns of length n^d .

We route in 3 phases:

1. Permute packets along the rows such that afterwards no column contains packets that have the same target row. $\mathcal{O}(d)$ steps.
2. We can use pipeling to permute **every** column, so that afterwards every packet is in its target row. $\mathcal{O}(2d + 2d)$ steps.
3. Every packet is in its target row. Permute packets to their right destinations. $\mathcal{O}(d)$ steps.

The nodes are of the form (ℓ, \bar{x}) , $\bar{x} \in [n]^d$, $\ell \in -d, \dots, d$.

We can view nodes with same first coordinate forming columns and nodes with the same second coordinate as forming rows. This gives rows of length $2d - 1$ and columns of length n^d .

We route in 3 phases:

1. Permute packets along the rows such that afterwards no column contains packets that have the same target row. $\mathcal{O}(d)$ steps.
2. We can use pipeling to permute **every** column, so that afterwards every packet is in its target row. $\mathcal{O}(2d + 2d)$ steps.
3. Every packet is in its target row. Permute packets to their right destinations. $\mathcal{O}(d)$ steps.

Lemma 58

We can do offline permutation routing of (partial) permutations in $2d$ steps on the hypercube.

Lemma 59

We can sort on the hypercube $M(2, d)$ in $\mathcal{O}(d^2)$ steps.

Lemma 60

We can do online permutation routing of permutations in $\mathcal{O}(d^2)$ steps on the hypercube.

Lemma 58

We can do offline permutation routing of (partial) permutations in $2d$ steps on the hypercube.

Lemma 59

We can sort on the hypercube $M(2, d)$ in $\mathcal{O}(d^2)$ steps.

Lemma 60

We can do online permutation routing of permutations in $\mathcal{O}(d^2)$ steps on the hypercube.

Lemma 58

We can do offline permutation routing of (partial) permutations in $2d$ steps on the hypercube.

Lemma 59

We can sort on the hypercube $M(2, d)$ in $\mathcal{O}(d^2)$ steps.

Lemma 60

We can do online permutation routing of permutations in $\mathcal{O}(d^2)$ steps on the hypercube.

Bitonic Sorter S_d

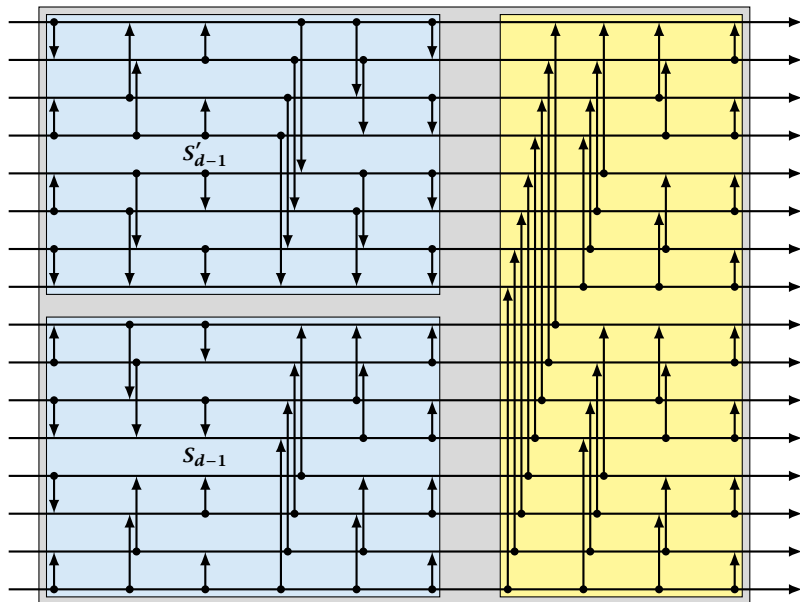

Algorithm 11 $\text{oper}(a, a', \text{dim}, T_a, T_{a'})$

1: **if** $a_{\text{dim}, \dots, a_0} = 0^{\text{dim}+1}$ **then**

2: $T_a = \min\{T_a, T_{a'}\}$

Performing an ASCEND run with this operation computes the minimum in processor 0.

We can sort on $M(2, d)$ by using d DESCEND runs.

We can do offline permutation routing by using a DESCEND run followed by an ASCEND run.

Algorithm 11 $\text{oper}(a, a', \text{dim}, T_a, T_{a'})$

1: **if** $a_{\text{dim}}, \dots, a_0 = 0^{\text{dim}+1}$ **then**

2: $T_a = \min\{T_a, T_{a'}\}$

Performing an ASCEND run with this operation computes the minimum in processor 0.

We can sort on $M(2, d)$ by using d DESCEND runs.

We can do offline permutation routing by using a DESCEND run followed by an ASCEND run.

Algorithm 11 $\text{oper}(a, a', \text{dim}, T_a, T_{a'})$

1: **if** $a_{\text{dim}, \dots, a_0} = 0^{\text{dim}+1}$ **then**

2: $T_a = \min\{T_a, T_{a'}\}$

Performing an ASCEND run with this operation computes the minimum in processor 0.

We can sort on $M(2, d)$ by using d DESCEND runs.

We can do offline permutation routing by using a DESCEND run followed by an ASCEND run.

Algorithm 11 $\text{oper}(a, a', \text{dim}, T_a, T_{a'})$

1: **if** $a_{\text{dim}, \dots, a_0} = 0^{\text{dim}+1}$ **then**

2: $T_a = \min\{T_a, T_{a'}\}$

Performing an ASCEND run with this operation computes the minimum in processor 0.

We can sort on $M(2, d)$ by using d DESCEND runs.

We can do offline permutation routing by using a DESCEND run followed by an ASCEND run.

We can perform an ASCEND/DESCEND run on a linear array $M(2^d, 1)$ in $\mathcal{O}(2^d)$ steps.

The CCC network is obtained from a hypercube by replacing every node by a cycle of degree d .

- ▶ nodes $\{(\ell, \bar{x}) \mid \bar{x} \in [2]^d, \ell \in [d]\}$
- ▶ edges $\{(\ell, \bar{x}), (\ell, \bar{x}(\ell)) \mid \bar{x} \in [2]^d, \ell \in [d]\}$

constant degree

Lemma 61

Let $d = 2^k$. An ASCEND run of a hypercube $M(2, d + k)$ can be simulated on $CCC(d)$ in $\mathcal{O}(d)$ steps.

The shuffle exchange network $SE(d)$ is defined as follows

▶ nodes: $V = [2]^d$

▶ edges:

$$E = \left\{ \{x\bar{\alpha}, \bar{\alpha}x\} \mid x \in [2], \bar{\alpha} \in [2]^{d-1} \right\} \cup \left\{ \{\bar{\alpha}0, \bar{\alpha}1\} \mid \bar{\alpha} \in [2]^{d-1} \right\}$$

constant degree

Edges of the first type are called **shuffle edges**. Edges of the second type are called **exchange edges**

Shuffle Exchange Networks

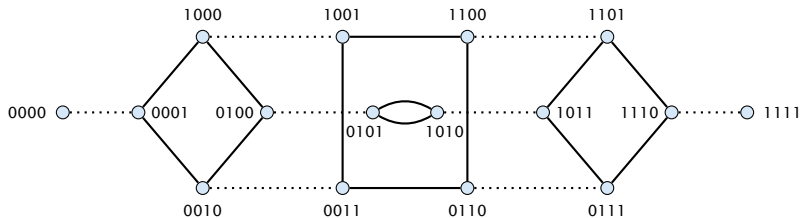
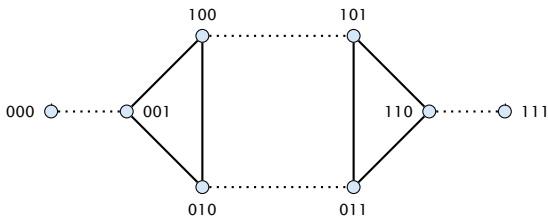

Lemma 62

We can perform an ASCEND run of $M(2, d)$ on $SE(d)$ in $\mathcal{O}(d)$ steps.

Simulations between Networks

For the following observations we need to make the definition of parallel computer networks more precise.

Each node of a given network corresponds to a processor/RAM.

In addition each processor has a **read register** and a **write register**.

In one (**synchronous**) step each neighbour of a processor P_i can write into P_i 's write register or can read from P_i 's read register.

Usually we assume that proper care has to be taken to avoid concurrent reads and concurrent writes from/to the same register.

Simulations between Networks

For the following observations we need to make the definition of parallel computer networks more precise.

Each node of a given network corresponds to a processor/RAM.

In addition each processor has a **read register** and a **write register**.

In one (**synchronous**) step each neighbour of a processor P_i can write into P_i 's write register or can read from P_i 's read register.

Usually we assume that proper care has to be taken to avoid concurrent reads and concurrent writes from/to the same register.

Simulations between Networks

For the following observations we need to make the definition of parallel computer networks more precise.

Each node of a given network corresponds to a processor/RAM.

In addition each processor has a **read register** and a **write register**.

In one (**synchronous**) step each neighbour of a processor P_i can write into P_i 's write register or can read from P_i 's read register.

Usually we assume that proper care has to be taken to avoid concurrent reads and concurrent writes from/to the same register.

Simulations between Networks

For the following observations we need to make the definition of parallel computer networks more precise.

Each node of a given network corresponds to a processor/RAM.

In addition each processor has a **read register** and a **write register**.

In one (**synchronous**) step each neighbour of a processor P_i can write into P_i 's write register or can read from P_i 's read register.

Usually we assume that proper care has to be taken to avoid concurrent reads and concurrent writes from/to the same register.

Simulations between Networks

For the following observations we need to make the definition of parallel computer networks more precise.

Each node of a given network corresponds to a processor/RAM.

In addition each processor has a **read register** and a **write register**.

In one (**synchronous**) step each neighbour of a processor P_i can write into P_i 's write register or can read from P_i 's read register.

Usually we assume that proper care has to be taken to avoid concurrent reads and concurrent writes from/to the same register.

Simulations between Networks

For the following observations we need to make the definition of parallel computer networks more precise.

Each node of a given network corresponds to a processor/RAM.

In addition each processor has a **read register** and a **write register**.

In one (**synchronous**) step each neighbour of a processor P_i can write into P_i 's write register or can read from P_i 's read register.

Usually we assume that proper care has to be taken to avoid concurrent reads and concurrent writes from/to the same register.

Simulations between Networks

Definition 63

A configuration C_i of processor P_i is the complete description of the state of P_i including local memory, program counter, read-register, write-register, etc.

Suppose a machine M is in configuration (C_0, \dots, C_{p-1}) , performs t synchronous steps, and is then in configuration $C = (C'_0, \dots, C'_{p-1})$.

C'_i is called the t -th successor configuration of C for processor i .

Simulations between Networks

Definition 63

A configuration C_i of processor P_i is the complete description of the state of P_i including local memory, program counter, read-register, write-register, etc.

Suppose a machine M is in configuration (C_0, \dots, C_{p-1}) , performs t synchronous steps, and is then in configuration $C = (C'_0, \dots, C'_{p-1})$.

C'_i is called the t -th successor configuration of C for processor i .

Simulations between Networks

Definition 63

A configuration C_i of processor P_i is the complete description of the state of P_i including local memory, program counter, read-register, write-register, etc.

Suppose a machine M is in configuration (C_0, \dots, C_{p-1}) , performs t synchronous steps, and is then in configuration $C = (C'_0, \dots, C'_{p-1})$.

C'_i is called the t -th successor configuration of C for processor i .

Simulations between Networks

Definition 64

Let $C = (C_0, \dots, C_{p-1})$ a configuration of M . A machine M' with $q \geq p$ processors **weakly simulates** t steps of M with slowdown k if

- ▶ in the beginning there are p non-empty processors sets $A_0, \dots, A_{p-1} \subseteq M'$ so that all processors in A_i know C_i ;
- ▶ after at most $k \cdot t$ steps of M' there is a processor $Q^{(i)}$ that knows the t -th successors configuration of C for processor P_i .

Simulations between Networks

Definition 65

M' **simulates** M with slowdown k if

- ▶ M' weakly simulates machine M with slowdown k
- ▶ and **every** processor in A_i knows the t -th successor configuration of C for processor P_i .

We have seen how to simulate an ASCEND/DESCEND run of the hypercube $M(2, d + k)$ on $CCC(d)$ with $d = 2^k$ in $\mathcal{O}(d)$ steps.

Hence, we can simulate $d + k$ steps (one ASCEND run) of the hypercube in $\mathcal{O}(d)$ steps. This means slowdown $\mathcal{O}(1)$.

Lemma 66

Suppose a network S with n processors can route any permutation in time $\mathcal{O}(t(n))$. Then S can simulate any **constant degree** network M with at most n vertices with slowdown $\mathcal{O}(t(n))$.

Map the vertices of M to vertices of S in an arbitrary way.

Color the edges of M with $\Delta + 1$ colors, where $\Delta = \mathcal{O}(1)$ denotes the maximum degree.

Each color gives rise to a permutation.

We can route this permutation in S in $t(n)$ steps.

Hence, we can perform the required communication for one step of M by routing $\Delta + 1$ permutations in S . This takes time $t(n)$.

A processor of M is simulated by the same processor of S throughout the simulation.

Map the vertices of M to vertices of S in an arbitrary way.

Color the edges of M with $\Delta + 1$ colors, where $\Delta = \mathcal{O}(1)$ denotes the maximum degree.

Each color gives rise to a permutation.

We can route this permutation in S in $t(n)$ steps.

Hence, we can perform the required communication for one step of M by routing $\Delta + 1$ permutations in S . This takes time $t(n)$.

A processor of M is simulated by the same processor of S throughout the simulation.

Map the vertices of M to vertices of S in an arbitrary way.

Color the edges of M with $\Delta + 1$ colors, where $\Delta = \mathcal{O}(1)$ denotes the maximum degree.

Each color gives rise to a permutation.

We can route this permutation in S in $t(n)$ steps.

Hence, we can perform the required communication for one step of M by routing $\Delta + 1$ permutations in S . This takes time $t(n)$.

A processor of M is simulated by the same processor of S throughout the simulation.

Map the vertices of M to vertices of S in an arbitrary way.

Color the edges of M with $\Delta + 1$ colors, where $\Delta = \mathcal{O}(1)$ denotes the maximum degree.

Each color gives rise to a permutation.

We can route this permutation in S in $t(n)$ steps.

Hence, we can perform the required communication for one step of M by routing $\Delta + 1$ permutations in S . This takes time $t(n)$.

A processor of M is simulated by the same processor of S throughout the simulation.

Map the vertices of M to vertices of S in an arbitrary way.

Color the edges of M with $\Delta + 1$ colors, where $\Delta = \mathcal{O}(1)$ denotes the maximum degree.

Each color gives rise to a permutation.

We can route this permutation in S in $t(n)$ steps.

Hence, we can perform the required communication for one step of M by routing $\Delta + 1$ permutations in S . This takes time $t(n)$.

A processor of M is simulated by the same processor of S throughout the simulation.

Map the vertices of M to vertices of S in an arbitrary way.

Color the edges of M with $\Delta + 1$ colors, where $\Delta = \mathcal{O}(1)$ denotes the maximum degree.

Each color gives rise to a permutation.

We can route this permutation in S in $t(n)$ steps.

Hence, we can perform the required communication for one step of M by routing $\Delta + 1$ permutations in S . This takes time $t(n)$.

A processor of M is simulated by the same processor of S throughout the simulation.

Lemma 67

Suppose a network S with n processors can sort n numbers in time $\mathcal{O}(t(n))$. Then S can simulate any network M with at most n vertices with slowdown $\mathcal{O}(t(n))$.

Lemma 68

There is a constant degree network on $\Theta(n^{1+\epsilon})$ nodes that can simulate any constant degree network with slowdown $\Theta(1)$.

Suppose we allow concurrent reads, this means in every step all neighbours of a processor P_i can read P_i 's read register.

Lemma 69

A constant degree network M that can simulate any n -node network has slowdown $\Omega(\log n)$ (independent of the size of M).

Suppose we allow concurrent reads, this means in every step all neighbours of a processor P_i can read P_i 's read register.

Lemma 69

A constant degree network M that can simulate any n -node network has slowdown $\Omega(\log n)$ (independent of the size of M).

We show the lemma for the following type of simulation.

- ▶ There are representative sets A_i^t for every step t that specify which processors of M simulate processor P_i in step t (know the configuration of P_i after the t -th step).
- ▶ The representative sets for different processors are disjoint.
- ▶ for all $i \in \{1, \dots, n\}$ and steps t , $A_i^t \neq \emptyset$.

This is a step-by-step simulation.

We show the lemma for the following type of simulation.

- ▶ There are representative sets A_i^t for every step t that specify which processors of M simulate processor P_i in step t (know the configuration of P_i after the t -th step).
- ▶ The representative sets for different processors are disjoint.
- ▶ for all $i \in \{1, \dots, n\}$ and steps t , $A_i^t \neq \emptyset$.

This is a step-by-step simulation.

Suppose processor P_i reads from processor P_{j_i} in step t .

Every processor $Q \in M$ with $Q \in A_i^{t+1}$ must have a path to a processor $Q' \in A_i^t$ and to $Q'' \in A_{j_i}^t$.

Let k_t be the largest distance (maximized over all i, j_i).

Then the simulation of step t takes time at least k_t .

The slowdown is at least

$$k = \frac{1}{\ell} \sum_{t=1}^{\ell} k_t$$

Suppose processor P_i reads from processor P_{j_i} in step t .

Every processor $Q \in M$ with $Q \in A_i^{t+1}$ must have a path to a processor $Q' \in A_i^t$ and to $Q'' \in A_{j_i}^t$.

Let k_t be the largest distance (maximized over all i, j_i).

Then the simulation of step t takes time at least k_t .

The slowdown is at least

$$k = \frac{1}{\ell} \sum_{t=1}^{\ell} k_t$$

Suppose processor P_i reads from processor P_{j_i} in step t .

Every processor $Q \in M$ with $Q \in A_i^{t+1}$ must have a path to a processor $Q' \in A_i^t$ and to $Q'' \in A_{j_i}^t$.

Let k_t be the largest distance (maximized over all i, j_i).

Then the simulation of step t takes time at least k_t .

The slowdown is at least

$$k = \frac{1}{\ell} \sum_{t=1}^{\ell} k_t$$

Suppose processor P_i reads from processor P_{j_i} in step t .

Every processor $Q \in M$ with $Q \in A_i^{t+1}$ must have a path to a processor $Q' \in A_i^t$ and to $Q'' \in A_{j_i}^t$.

Let k_t be the largest distance (maximized over all i, j_i).

Then the simulation of step t takes time at least k_t .

The slowdown is at least

$$k = \frac{1}{\ell} \sum_{t=1}^{\ell} k_t$$

Suppose processor P_i reads from processor P_{j_i} in step t .

Every processor $Q \in M$ with $Q \in A_i^{t+1}$ must have a path to a processor $Q' \in A_i^t$ and to $Q'' \in A_{j_i}^t$.

Let k_t be the largest distance (maximized over all i, j_i).

Then the simulation of step t takes time at least k_t .

The slowdown is at least

$$k = \frac{1}{\ell} \sum_{t=1}^{\ell} k_t$$

We show

- ▶ The simulation of a step takes at least time $\gamma \log n$, or
- ▶ the size of the representative sets shrinks by a lot

$$\sum_i |A_i^{t+1}| \leq \frac{1}{n^\epsilon} \sum_i |A_i^t|$$

We show

- ▶ The simulation of a step takes at least time $\gamma \log n$, or
- ▶ the size of the representative sets shrinks by a lot

$$\sum_i |A_i^{t+1}| \leq \frac{1}{n^\epsilon} \sum_i |A_i^t|$$

Suppose there is no pair (i, j) such that i reading from j requires time $\gamma \log n$.

Suppose there is no pair (i, j) such that i reading from j requires time $\gamma \log n$.

- ▶ For every i the set $\Gamma_{2k}(A_i)$ contains a node from A_j .
- ▶ Hence, there must exist a j_i such that $\Gamma_{2k}(A_i)$ contains at most

$$|C_{j_i}| := \frac{|A_i| \cdot c^{2k}}{n-1} \leq \frac{|A_i| \cdot c^{3k}}{n}.$$

processors from $|A_{j_i}|$

Suppose there is no pair (i, j) such that i reading from j requires time $\gamma \log n$.

- ▶ For every i the set $\Gamma_{2k}(A_i)$ contains a node from A_j .
- ▶ Hence, there must exist a j_i such that $\Gamma_{2k}(A_i)$ contains at most

$$|C_{j_i}| := \frac{|A_i| \cdot c^{2k}}{n-1} \leq \frac{|A_i| \cdot c^{3k}}{n} .$$

processors from $|A_{j_i}|$

If we choose that i reads from j_i we get

$$|A'_i|$$

If we choose that i reads from j_i we get

$$|A'_i| \leq |C_{j_i}| \cdot c^k$$

If we choose that i reads from j_i we get

$$\begin{aligned} |A'_i| &\leq |C_{j_i}| \cdot c^k \\ &\leq c^k \cdot \frac{|A_i| \cdot c^{3k}}{n} \end{aligned}$$

If we choose that i reads from j_i we get

$$\begin{aligned} |A'_i| &\leq |C_{j_i}| \cdot c^k \\ &\leq c^k \cdot \frac{|A_i| \cdot c^{3k}}{n} \\ &= \frac{1}{n} |A_i| \cdot c^{4k} \end{aligned}$$

If we choose that i reads from j_i we get

$$\begin{aligned} |A'_i| &\leq |C_{j_i}| \cdot c^k \\ &\leq c^k \cdot \frac{|A_i| \cdot c^{3k}}{n} \\ &= \frac{1}{n} |A_i| \cdot c^{4k} \end{aligned}$$

If we choose that i reads from j_i we get

$$\begin{aligned} |A'_i| &\leq |C_{j_i}| \cdot c^k \\ &\leq c^k \cdot \frac{|A_i| \cdot c^{3k}}{n} \\ &= \frac{1}{n} |A_i| \cdot c^{4k} \end{aligned}$$

Choosing $k = \Theta(\log n)$ gives that this is at most $|A_i|/n^\epsilon$.

Let ℓ be the total number of steps and s be the number of **short** steps when $k_t < \gamma \log n$.

In a step of time k_t a representative set can at most increase by c^{k_t+1} .

Let h_ℓ denote the number of representatives after step ℓ .

Let ℓ be the total number of steps and s be the number of **short** steps when $k_t < \gamma \log n$.

In a step of time k_t a representative set can at most increase by c^{k_t+1} .

Let h_ℓ denote the number of representatives after step ℓ .

Let ℓ be the total number of steps and s be the number of **short** steps when $k_t < \gamma \log n$.

In a step of time k_t a representative set can at most increase by c^{k_t+1} .

Let h_ℓ denote the number of representatives after step ℓ .

$$n \leq h_\ell \leq h_0 \left(\frac{1}{n^\epsilon} \right)^s \prod_{t \in \text{long}} c^{k_t+1} \leq \frac{n}{n^{\epsilon s}} \cdot c^{\ell + \sum_t k_t}$$

If $\sum_t k_t \geq \ell \left(\frac{\epsilon}{2} \log_c n - 1 \right)$, we are done. Otw.

$$n \leq n^{1 - \epsilon s + \ell \frac{\epsilon}{2}}$$

This gives $s \leq \ell/2$.

Hence, at most 50% of the steps are short.

$$n \leq h_\ell \leq h_0 \left(\frac{1}{n^\epsilon} \right)^s \prod_{t \in \text{long}} c^{k_t+1} \leq \frac{n}{n^{\epsilon s}} \cdot c^{\ell + \sum_t k_t}$$

If $\sum_t k_t \geq \ell \left(\frac{\epsilon}{2} \log_c n - 1 \right)$, we are done. Otw.

$$n \leq n^{1 - \epsilon s + \ell \frac{\epsilon}{2}}$$

This gives $s \leq \ell/2$.

Hence, at most 50% of the steps are short.

$$n \leq h_\ell \leq h_0 \left(\frac{1}{n^\epsilon} \right)^s \prod_{t \in \text{long}} c^{k_t+1} \leq \frac{n}{n^{\epsilon s}} \cdot c^{\ell + \sum_t k_t}$$

If $\sum_t k_t \geq \ell \left(\frac{\epsilon}{2} \log_c n - 1 \right)$, we are done. Otw.

$$n \leq n^{1 - \epsilon s + \ell \frac{\epsilon}{2}}$$

This gives $s \leq \ell/2$.

Hence, at most 50% of the steps are short.

$$n \leq h_\ell \leq h_0 \left(\frac{1}{n^\epsilon} \right)^s \prod_{t \in \text{long}} c^{k_t+1} \leq \frac{n}{n^{\epsilon s}} \cdot c^{\ell + \sum_t k_t}$$

If $\sum_t k_t \geq \ell \left(\frac{\epsilon}{2} \log_c n - 1 \right)$, we are done. Otw.

$$n \leq n^{1 - \epsilon s + \ell \frac{\epsilon}{2}}$$

This gives $s \leq \ell/2$.

Hence, at most 50% of the steps are short.

Deterministic Online Routing

Lemma 70

*A permutation on an $n \times n$ -mesh can be routed **online** in $\mathcal{O}(n)$ steps.*

Deterministic Online Routing

Definition 71 (Oblivious Routing)

Specify a path-system \mathcal{W} with a path $P_{u,v}$ between u and v for every pair $\{u, v\} \in V \times V$.

A packet with source u and destination v moves along path $P_{u,v}$.

Deterministic Online Routing

Definition 72 (Oblivious Routing)

Specify a path-system \mathcal{W} with a path $P_{u,v}$ between u and v for every pair $\{u, v\} \in V \times V$.

Definition 73 (node congestion)

For a given path-system the **node congestion** is the maximum number of path that go through any node $v \in V$.

Definition 74 (edge congestion)

For a given path-system the **edge congestion** is the maximum number of path that go through any edge $e \in E$.

Deterministic Online Routing

Definition 75 (dilation)

For a given path system the **dilation** is the maximum length of a path.

Lemma 76

Any oblivious routing protocol requires at least $\max\{C_f, D_f\}$ steps, where C_f and D_f , are the congestion and dilation, respectively, of the path-system used. (node congestion or edge congestion depending on the communication model)

Lemma 77

*Any reasonable oblivious routing protocol requires at most $\mathcal{O}(D_f \cdot C_f)$ steps (**unbounded buffers**).*

Theorem 78 (Borodin, Hopcroft)

For any path system \mathcal{W} there exists a permutation $\pi : V \rightarrow V$ and an edge $e \in E$ such that at least $\Omega(\sqrt{n}/\Delta)$ of the paths go through e .

Let $\mathcal{W}_v = \{P_{v,u} \mid u \in V\}$.

We say that an edge e is **z -popular** for v if at least z paths from \mathcal{W}_v contain e .

For any node v there are many edges that are quite popular for v .

$|V| \times |E|$ -matrix $A(z)$:

$$A_{v,e}(z) = \begin{cases} 1 & e \text{ is } z\text{-popular for } v \\ 0 & \text{otherwise} \end{cases}$$

Define



$$A_v(z) = \sum_e A_{v,e}(z)$$



$$A_e(z) = \sum_v A_{v,e}(z)$$

Lemma 79

Let $z \leq \frac{n-1}{\Delta}$.

For every node $v \in V$ there exist at least $\frac{n}{2\Delta z}$ edges that are z popular for v . This means

$$A_v(z) \geq \frac{n}{2\Delta z}$$

Lemma 80

There exists an edge e' that is z -popular for at least z nodes with $z = \Omega(\sqrt{n}\Delta)$.

$$\sum_e A_e(z) = \sum_v A_v(z) \geq \frac{n^2}{2\Delta z}$$

There must exist an edge e'

$$A_{e'}(z) \geq \left\lceil \frac{n^2}{|E| \cdot 2\Delta z} \right\rceil \geq \left\lceil \frac{n}{2\Delta^2 z} \right\rceil$$

where the last step follows from $|E| \leq \Delta n$.

We choose z such that $z = \frac{n}{2\Delta^2 z}$ (i.e., $z = \sqrt{n}/(\sqrt{2}\Delta)$).

This means e' is $\lceil z \rceil$ -popular for $\lceil z \rceil$ nodes.

We can construct a permutation such that z paths go through e' .

Deterministic oblivious routing may perform very poorly.

What happens if we have a random routing problem in a butterfly?

Suppose every source on level 0 has p packets, that are routed to random destinations.

How many packets go over node v on level i ?

From v we can reach $2^d/2^i$ different targets.

Hence,

$$\Pr[\text{packet goes over } v] \leq \frac{2^{d-i}}{2^d} = \frac{1}{2^i}$$

Suppose every source on level 0 has p packets, that are routed to random destinations.

How many packets go over node v on level i ?

From v we can reach $2^d/2^i$ different targets.

Hence,

$$\Pr[\text{packet goes over } v] \leq \frac{2^{d-i}}{2^d} = \frac{1}{2^i}$$

Suppose every source on level 0 has p packets, that are routed to random destinations.

How many packets go over node v on level i ?

From v we can reach $2^d/2^i$ different targets.

Hence,

$$\Pr[\text{packet goes over } v] \leq \frac{2^{d-i}}{2^d} = \frac{1}{2^i}$$

Suppose every source on level 0 has p packets, that are routed to random destinations.

How many packets go over node v on level i ?

From v we can reach $2^d/2^i$ different targets.

Hence,

$$\Pr[\text{packet goes over } v] \leq \frac{2^{d-i}}{2^d} = \frac{1}{2^i}$$

Expected number of packets:

$$E[\text{packets over } v] = p \cdot 2^i \cdot \frac{1}{2^i} = p$$

since only $p2^i$ packets can reach v .

But this is trivial.

Expected number of packets:

$$E[\text{packets over } v] = p \cdot 2^i \cdot \frac{1}{2^i} = p$$

since only $p2^i$ packets can reach v .

But this is trivial.

What is the probability that at least r packets go through v .

$$\begin{aligned}\Pr[\text{at least } r \text{ path through } v] &\leq \binom{p \cdot 2^i}{r} \cdot \left(\frac{1}{2^i}\right)^r \\ &\leq \left(\frac{p2^i \cdot e}{r}\right)^r \cdot \left(\frac{1}{2^i}\right)^r \\ &= \left(\frac{pe}{r}\right)^r\end{aligned}$$

$\Pr[\text{there exists a node } v \text{ such that at least } r \text{ path through } v]$

$$\leq d2^d \cdot \left(\frac{pe}{r}\right)^r$$

What is the probability that at least r packets go through v .

$$\begin{aligned}\Pr[\text{at least } r \text{ path through } v] &\leq \binom{p \cdot 2^i}{r} \cdot \left(\frac{1}{2^i}\right)^r \\ &\leq \left(\frac{p2^i \cdot e}{r}\right)^r \cdot \left(\frac{1}{2^i}\right)^r \\ &= \left(\frac{pe}{r}\right)^r\end{aligned}$$

$\Pr[\text{there exists a node } v \text{ such that at least } r \text{ path through } v]$

$$\leq d2^d \cdot \left(\frac{pe}{r}\right)^r$$

What is the probability that at least r packets go through v .

$$\begin{aligned}\Pr[\text{at least } r \text{ path through } v] &\leq \binom{p \cdot 2^i}{r} \cdot \left(\frac{1}{2^i}\right)^r \\ &\leq \left(\frac{p 2^i \cdot e}{r}\right)^r \cdot \left(\frac{1}{2^i}\right)^r \\ &= \left(\frac{pe}{r}\right)^r\end{aligned}$$

$\Pr[\text{there exists a node } v \text{ such that at least } r \text{ path through } v]$

$$\leq d 2^d \cdot \left(\frac{pe}{r}\right)^r$$

What is the probability that at least r packets go through v .

$$\begin{aligned}\Pr[\text{at least } r \text{ path through } v] &\leq \binom{p \cdot 2^i}{r} \cdot \left(\frac{1}{2^i}\right)^r \\ &\leq \left(\frac{p2^i \cdot e}{r}\right)^r \cdot \left(\frac{1}{2^i}\right)^r \\ &= \left(\frac{pe}{r}\right)^r\end{aligned}$$

$\Pr[\text{there exists a node } v \text{ such that at least } r \text{ path through } v]$

$$\leq d2^d \cdot \left(\frac{pe}{r}\right)^r$$

What is the probability that at least r packets go through v .

$$\begin{aligned}\Pr[\text{at least } r \text{ path through } v] &\leq \binom{p \cdot 2^i}{r} \cdot \left(\frac{1}{2^i}\right)^r \\ &\leq \left(\frac{p 2^i \cdot e}{r}\right)^r \cdot \left(\frac{1}{2^i}\right)^r \\ &= \left(\frac{pe}{r}\right)^r\end{aligned}$$

\Pr [there **exists** a node v such that at least r path through v]

$$\leq d 2^d \cdot \left(\frac{pe}{r}\right)^r$$

What is the probability that at least r packets go through v .

$$\begin{aligned}\Pr[\text{at least } r \text{ path through } v] &\leq \binom{p \cdot 2^i}{r} \cdot \left(\frac{1}{2^i}\right)^r \\ &\leq \left(\frac{p2^i \cdot e}{r}\right)^r \cdot \left(\frac{1}{2^i}\right)^r \\ &= \left(\frac{pe}{r}\right)^r\end{aligned}$$

\Pr [there **exists** a node v such that at least r path through v]

$$\leq d2^d \cdot \left(\frac{pe}{r}\right)^r$$

Pr[there **exists** a node v such that at least r path through v]

$$\leq d2^d \cdot \left(\frac{pe}{r}\right)^r$$

Choose r as $2ep + (\ell + 1)d + \log d = \mathcal{O}(p + \log N)$, where N is number of sources in $\text{BF}(d)$.

$$\text{Pr}[\text{exists node } v \text{ with more than } r \text{ paths over } v] \leq \frac{1}{N^\ell}$$

Pr[there **exists** a node v such that at least r path through v]

$$\leq d2^d \cdot \left(\frac{pe}{r}\right)^r$$

Choose r as $2ep + (\ell + 1)d + \log d = \mathcal{O}(p + \log N)$, where N is number of sources in $\text{BF}(d)$.

$$\text{Pr}[\text{exists node } v \text{ with more than } r \text{ paths over } v] \leq \frac{1}{N^\ell}$$

Pr[there **exists** a node v such that at least r path through v]

$$\leq d2^d \cdot \left(\frac{pe}{r}\right)^r$$

Choose r as $2ep + (\ell + 1)d + \log d = \mathcal{O}(p + \log N)$, where N is number of sources in $\text{BF}(d)$.

$$\text{Pr}[\text{exists node } v \text{ with more than } r \text{ paths over } v] \leq \frac{1}{N^\ell}$$

Pr[there **exists** a node v such that at least r path through v]

$$\leq d2^d \cdot \left(\frac{pe}{r}\right)^r$$

Choose r as $2ep + (\ell + 1)d + \log d = \mathcal{O}(p + \log N)$, where N is number of sources in $\text{BF}(d)$.

$$\text{Pr}[\text{exists node } v \text{ with more than } r \text{ paths over } v] \leq \frac{1}{N^\ell}$$

Pr[there **exists** a node v such that at least r path through v]

$$\leq d2^d \cdot \left(\frac{pe}{r}\right)^r$$

Choose r as $2ep + (\ell + 1)d + \log d = \mathcal{O}(p + \log N)$, where N is number of sources in $\text{BF}(d)$.

$$\text{Pr}[\text{exists node } v \text{ with more than } r \text{ paths over } v] \leq \frac{1}{N^\ell}$$

Scheduling Packets

Assume that in every round a node may forward at most one packet but may receive up to two.

We select a random rank $R_p \in [k]$. Whenever, we forward a packet we choose the packet with smaller rank. Ties are broken according to packet id.

Random Rank Protocol

Scheduling Packets

Assume that in every round a node may forward at most one packet but may receive up to two.

We select a random rank $R_p \in [k]$. Whenever, we forward a packet we choose the packet with smaller rank. Ties are broken according to packet id.

Random Rank Protocol

Scheduling Packets

Assume that in every round a node may forward at most one packet but may receive up to two.

We select a random rank $R_p \in [k]$. Whenever, we forward a packet we choose the packet with smaller rank. Ties are broken according to packet id.

Random Rank Protocol

Scheduling Packets

Assume that in every round a node may forward at most one packet but may receive up to two.

We select a random rank $R_p \in [k]$. Whenever, we forward a packet we choose the packet with smaller rank. Ties are broken according to packet id.

Random Rank Protocol

Definition 81 (Delay Sequence of length s)

- ▶ **delay path** \mathcal{W}
- ▶ lengths l_0, l_1, \dots, l_s , with $l_0 \geq 1, l_1, \dots, l_s \geq 0$ lengths of **delay-free sub-paths**
- ▶ **collision nodes** $v_0, v_1, \dots, v_s, v_{s+1}$
- ▶ **collision packets** P_0, \dots, P_s

Definition 81 (Delay Sequence of length s)

- ▶ delay path \mathcal{W}
- ▶ lengths $\ell_0, \ell_1, \dots, \ell_s$, with $\ell_0 \geq 1, \ell_1, \dots, \ell_s \geq 0$ lengths of delay-free sub-paths
- ▶ collision nodes $v_0, v_1, \dots, v_s, v_{s+1}$
- ▶ collision packets P_0, \dots, P_s

Definition 81 (Delay Sequence of length s)

- ▶ **delay path** \mathcal{W}
- ▶ **lengths** $\ell_0, \ell_1, \dots, \ell_s$, with $\ell_0 \geq 1, \ell_1, \dots, \ell_s \geq 0$ **lengths of delay-free sub-paths**
- ▶ **collision nodes** $v_0, v_1, \dots, v_s, v_{s+1}$
- ▶ **collision packets** P_0, \dots, P_s

Definition 81 (Delay Sequence of length s)

- ▶ **delay path** \mathcal{W}
- ▶ **lengths** $\ell_0, \ell_1, \dots, \ell_s$, with $\ell_0 \geq 1, \ell_1, \dots, \ell_s \geq 0$ **lengths of delay-free sub-paths**
- ▶ **collision nodes** $v_0, v_1, \dots, v_s, v_{s+1}$
- ▶ **collision packets** P_0, \dots, P_s

Properties

- ▶ $\text{rank}(P_0) \geq \text{rank}(P_1) \geq \dots \geq \text{rank}(P_s)$
- ▶ $\sum_{i=0}^s l_i = d$
- ▶ if the routing takes $d + s$ steps then the delay sequence has length s

Properties

- ▶ $\text{rank}(P_0) \geq \text{rank}(P_1) \geq \dots \geq \text{rank}(P_s)$
- ▶ $\sum_{i=0}^s \ell_i = d$
- ▶ if the routing takes $d + s$ steps then the delay sequence has length s

Properties

- ▶ $\text{rank}(P_0) \geq \text{rank}(P_1) \geq \dots \geq \text{rank}(P_s)$
- ▶ $\sum_{i=0}^s \ell_i = d$
- ▶ if the routing takes $d + s$ steps than the delay sequence has length s

Definition 82 (Formal Delay Sequence)

- ▶ a path \mathcal{W} of length d from a source to a target
- ▶ s integers $l_0 \geq 1, l_1, \dots, l_s \geq 0$ and $\sum_{i=0}^s l_i = d$
- ▶ nodes v_0, \dots, v_s, v_{s+1} on \mathcal{W} with v_i being on level $d - l_0 - \dots - l_{i-1}$
- ▶ $s + 1$ packets P_0, \dots, P_s , where P_i is a packet with path through v_i and v_{i-1}
- ▶ numbers $R_s \leq R_{s-1} \leq \dots \leq R_0$

Definition 82 (Formal Delay Sequence)

- ▶ a path \mathcal{W} of length d from a source to a target
- ▶ s integers $\ell_0 \geq 1, \ell_1, \dots, \ell_s \geq 0$ and $\sum_{i=0}^s \ell_i = d$
- ▶ nodes v_0, \dots, v_s, v_{s+1} on \mathcal{W} with v_i being on level $d - \ell_0 - \dots - \ell_{i-1}$
- ▶ $s + 1$ packets P_0, \dots, P_s , where P_i is a packet with path through v_i and v_{i-1}
- ▶ numbers $R_s \leq R_{s-1} \leq \dots \leq R_0$

Definition 82 (Formal Delay Sequence)

- ▶ a path \mathcal{W} of length d from a source to a target
- ▶ s integers $\ell_0 \geq 1, \ell_1, \dots, \ell_s \geq 0$ and $\sum_{i=0}^s \ell_i = d$
- ▶ nodes v_0, \dots, v_s, v_{s+1} on \mathcal{W} with v_i being on level $d - \ell_0 - \dots - \ell_{i-1}$
- ▶ $s + 1$ packets P_0, \dots, P_s , where P_i is a packet with path through v_i and v_{i-1}
- ▶ numbers $R_s \leq R_{s-1} \leq \dots \leq R_0$

Definition 82 (Formal Delay Sequence)

- ▶ a path \mathcal{W} of length d from a source to a target
- ▶ s integers $\ell_0 \geq 1, \ell_1, \dots, \ell_s \geq 0$ and $\sum_{i=0}^s \ell_i = d$
- ▶ nodes v_0, \dots, v_s, v_{s+1} on \mathcal{W} with v_i being on level $d - \ell_0 - \dots - \ell_{i-1}$
- ▶ $s + 1$ packets P_0, \dots, P_s , where P_i is a packet with path through v_i and v_{i-1}
- ▶ numbers $R_s \leq R_{s-1} \leq \dots \leq R_0$

Definition 82 (Formal Delay Sequence)

- ▶ a path \mathcal{W} of length d from a source to a target
- ▶ s integers $\ell_0 \geq 1, \ell_1, \dots, \ell_s \geq 0$ and $\sum_{i=0}^s \ell_i = d$
- ▶ nodes v_0, \dots, v_s, v_{s+1} on \mathcal{W} with v_i being on level $d - \ell_0 - \dots - \ell_{i-1}$
- ▶ $s + 1$ packets P_0, \dots, P_s , where P_i is a packet with path through v_i and v_{i-1}
- ▶ numbers $R_s \leq R_{s-1} \leq \dots \leq R_0$

We say a formal delay sequence is **active** if $\text{rank}(P_i) = k_i$ holds for all i .

Let N_s be the number of formal delay sequences of length at most s . Then

$$\Pr[\text{routing needs at least } d + s \text{ steps}] \leq \frac{N_s}{k^{s+1}}$$

We say a formal delay sequence is **active** if $\text{rank}(P_i) = k_i$ holds for all i .

Let N_s be the number of formal delay sequences of length at most s . Then

$$\Pr[\text{routing needs at least } d + s \text{ steps}] \leq \frac{N_s}{k^{s+1}}$$

Lemma 83

$$N_s \leq \left(\frac{2eC(s+k)}{s+1} \right)^{s+1}$$

Lemma 83

$$N_s \leq \left(\frac{2eC(s+k)}{s+1} \right)^{s+1}$$

- ▶ there are N^2 ways to choose \mathcal{W}
- ▶ there are $\binom{s+d-1}{s}$ ways to choose l_i 's with $\sum_{i=0}^s l_i = d$
- ▶ the collision nodes are fixed
- ▶ there are at most C^{s+1} ways to choose the collision packets where C is the node congestion
- ▶ there are at most $\binom{s+k}{s+1}$ ways to choose $0 \leq k_s \leq \dots \leq k_0 < k$

Lemma 83

$$N_s \leq \left(\frac{2eC(s+k)}{s+1} \right)^{s+1}$$

- ▶ there are N^2 ways to choose \mathcal{W}
- ▶ there are $\binom{s+d-1}{s}$ ways to choose ℓ_i 's with $\sum_{i=0}^s \ell_i = d$
- ▶ the collision nodes are fixed
- ▶ there are at most C^{s+1} ways to choose the collision packets where C is the node congestion
- ▶ there are at most $\binom{s+k}{s+1}$ ways to choose $0 \leq k_s \leq \dots \leq k_0 < k$

Lemma 83

$$N_s \leq \left(\frac{2eC(s+k)}{s+1} \right)^{s+1}$$

- ▶ there are N^2 ways to choose \mathcal{W}
- ▶ there are $\binom{s+d-1}{s}$ ways to choose ℓ_i 's with $\sum_{i=0}^s \ell_i = d$
- ▶ the collision nodes are fixed
- ▶ there are at most C^{s+1} ways to choose the collision packets where C is the node congestion
- ▶ there are at most $\binom{s+k}{s+1}$ ways to choose $0 \leq k_s \leq \dots \leq k_0 < k$

Lemma 83

$$N_s \leq \left(\frac{2eC(s+k)}{s+1} \right)^{s+1}$$

- ▶ there are N^2 ways to choose \mathcal{W}
- ▶ there are $\binom{s+d-1}{s}$ ways to choose ℓ_i 's with $\sum_{i=0}^s \ell_i = d$
- ▶ the collision nodes are fixed
- ▶ there are at most C^{s+1} ways to choose the collision packets where C is the node congestion
- ▶ there are at most $\binom{s+k}{s+1}$ ways to choose $0 \leq k_s \leq \dots \leq k_0 < k$

Hence the probability that the routing takes more than $d + s$ steps is at most

$$N^3 \cdot \left(\frac{2e \cdot C \cdot (s + k)}{(s + 1)k} \right)^{s+1}$$

We choose $s = 8eC - 1 + (\ell + 3)d$ and $k = s + 1$. This gives that the probability is at most $\frac{1}{N^\ell}$.

Hence the probability that the routing takes more than $d + s$ steps is at most

$$N^3 \cdot \left(\frac{2e \cdot C \cdot (s + k)}{(s + 1)k} \right)^{s+1}$$

We choose $s = 8eC - 1 + (\ell + 3)d$ and $k = s + 1$. This gives that the probability is at most $\frac{1}{N^\ell}$.

- ▶ With probability $1 - \frac{1}{N^{\ell_1}}$ the random routing problem has congestion at most $\mathcal{O}(p + \ell_1 d)$.
- ▶ With probability $1 - \frac{1}{N^{\ell_2}}$ the packet scheduling finishes in at most $\mathcal{O}(C + \ell_2 d)$ steps.

Hence, with high probability routing random problems with p packets per source in a butterfly requires only $\mathcal{O}(p + d)$ steps.

What do we do for arbitrary routing problems?

- ▶ With probability $1 - \frac{1}{N^{\ell_1}}$ the random routing problem has congestion at most $\mathcal{O}(p + \ell_1 d)$.
- ▶ With probability $1 - \frac{1}{N^{\ell_2}}$ the packet scheduling finishes in at most $\mathcal{O}(C + \ell_2 d)$ steps.

Hence, with high probability routing random problems with p packets per source in a butterfly requires only $\mathcal{O}(p + d)$ steps.

What do we do for arbitrary routing problems?

- ▶ With probability $1 - \frac{1}{N^{\ell_1}}$ the random routing problem has congestion at most $\mathcal{O}(p + \ell_1 d)$.
- ▶ With probability $1 - \frac{1}{N^{\ell_2}}$ the packet scheduling finishes in at most $\mathcal{O}(C + \ell_2 d)$ steps.

Hence, with high probability routing random problems with p packets per source in a butterfly requires only $\mathcal{O}(p + d)$ steps.

What do we do for arbitrary routing problems?

- ▶ With probability $1 - \frac{1}{N^{\ell_1}}$ the random routing problem has congestion at most $\mathcal{O}(p + \ell_1 d)$.
- ▶ With probability $1 - \frac{1}{N^{\ell_2}}$ the packet scheduling finishes in at most $\mathcal{O}(C + \ell_2 d)$ steps.

Hence, with high probability routing random problems with p packets per source in a butterfly requires only $\mathcal{O}(p + d)$ steps.

What do we do for arbitrary routing problems?

- ▶ With probability $1 - \frac{1}{N^{\ell_1}}$ the random routing problem has congestion at most $\mathcal{O}(p + \ell_1 d)$.
- ▶ With probability $1 - \frac{1}{N^{\ell_2}}$ the packet scheduling finishes in at most $\mathcal{O}(C + \ell_2 d)$ steps.

Hence, with high probability routing random problems with p packets per source in a butterfly requires only $\mathcal{O}(p + d)$ steps.

What do we do for arbitrary routing problems?

Valiants Trick

Where did the scheduling analysis use the butterfly?

We only used

- ▶ all routing paths are of the same length d
- ▶ there are a polynomial number of delay paths

Choose paths as follows:

- ▶ route from source to random destination on target level
- ▶ route to real target column (albeit on source level)
- ▶ route to target

All phases run in time $\mathcal{O}(p + d)$ with high probability.

Valiants Trick

Where did the scheduling analysis use the butterfly?

We only used

- ▶ all routing paths are of the same length d
- ▶ there are a polynomial number of delay paths

Choose paths as follows:

- ▶ route from source to random destination on target level
- ▶ route to real target column (albeit on source level)
- ▶ route to target

All phases run in time $\mathcal{O}(p + d)$ with high probability.

Valiants Trick

Where did the scheduling analysis use the butterfly?

We only used

- ▶ all routing paths are of the same length d
- ▶ there are a polynomial number of delay paths

Choose paths as follows:

- ▶ route from source to random destination on target level
- ▶ route to real target column (albeit on source level)
- ▶ route to target

All phases run in time $\mathcal{O}(p + d)$ with high probability.

Valiants Trick

Where did the scheduling analysis use the butterfly?

We only used

- ▶ all routing paths are of the same length d
- ▶ there are a polynomial number of delay paths

Choose paths as follows:

- ▶ route from source to random destination on target level
- ▶ route to real target column (albeit on source level)
- ▶ route to target

All phases run in time $\mathcal{O}(p + d)$ with high probability.

Multicommodity Flow Problem

- ▶ undirected (weighted) graph $G = (V, E, c)$
- ▶ commodities (s_i, t_i) , $i \in \{1, \dots, k\}$
- ▶ a **multicommodity flow** is a flow $f : E \times \{1, \dots, k\} \rightarrow \mathbb{R}^+$
 - ▶ for all edges $e \in E$, $\sum_i f_i(e) \leq c(e)$
 - ▶ for all nodes $w \in V$, $\sum_{(s_i, w) \in E} f_i(s_i, w) = \sum_{(w, t_i) \in E} f_i(w, t_i)$

Goal A (Maximum Multicommodity Flow)

maximize $\sum_i \sum_{e=(s_i, x) \in E} f_i(e)$

Goal B (Maximum Concurrent Multicommodity Flow)

maximize $\min_i \sum_{e=(s_i, x) \in E} f_i(e) / d_i$ (throughput fraction), where d_i is **demand for commodity i**

Valiants Trick

Multicommodity Flow Problem

- ▶ undirected (weighted) graph $G = (V, E, c)$
- ▶ commodities $(s_i, t_i), i \in \{1, \dots, k\}$
- ▶ a **multicommodity flow** is a flow $f : E \times \{1, \dots, k\} \rightarrow \mathbb{R}^+$
 - ▶ for all edges $e \in E, \sum_i f_i(e) \leq c(e)$
 - ▶ for all nodes $x \neq y \in V$
 - ▶ $\sum_{e=(x,y)} f_i(e) = \sum_{e=(y,x)} f_i(e)$

Goal A (Maximum Multicommodity Flow)

maximize $\sum_i \sum_{e=(s_i, x) \in E} f_i(e)$

Goal B (Maximum Concurrent Multicommodity Flow)

maximize $\min_i \sum_{e=(s_i, x) \in E} f_i(e) / d_i$ (throughput fraction), where d_i is **demand for commodity i**

Valiants Trick

Multicommodity Flow Problem

- ▶ undirected (weighted) graph $G = (V, E, c)$
- ▶ commodities (s_i, t_i) , $i \in \{1, \dots, k\}$
- ▶ a **multicommodity flow** is a flow $f : E \times \{1, \dots, k\} \rightarrow \mathbb{R}^+$
 - ▶ for all edges $e \in E$: $\sum_i f_i(e) \leq c(e)$
 - ▶ for all nodes $v \in V \setminus \{s_i, t_i\}$:
$$\sum_{u:(u,v) \in E} f_i((u,v)) = \sum_{w:(v,w) \in E} f_i((v,w))$$

Goal A (Maximum Multicommodity Flow)

maximize $\sum_i \sum_{e=(s_i,x) \in E} f_i(e)$

Goal B (Maximum Concurrent Multicommodity Flow)

maximize $\min_i \sum_{e=(s_i,x) \in E} f_i(e) / d_i$ (throughput fraction), where d_i is demand for commodity i

Valiants Trick

Multicommodity Flow Problem

- ▶ undirected (weighted) graph $G = (V, E, c)$
- ▶ commodities (s_i, t_i) , $i \in \{1, \dots, k\}$
- ▶ a **multicommodity flow** is a flow $f : E \times \{1, \dots, k\} \rightarrow \mathbb{R}^+$
 - ▶ for all edges $e \in E$: $\sum_i f_i(e) \leq c(e)$
 - ▶ for all nodes $v \in V \setminus \{s_i, t_i\}$:
$$\sum_{u:(u,v) \in E} f_i((u,v)) = \sum_{w:(v,w) \in E} f_i((v,w))$$

Goal A (Maximum Multicommodity Flow)

maximize $\sum_i \sum_{e=(s_i, x) \in E} f_i(e)$

Goal B (Maximum Concurrent Multicommodity Flow)

maximize $\min_i \sum_{e=(s_i, x) \in E} f_i(e) / d_i$ (throughput fraction), where d_i is demand for commodity i

Valiants Trick

Multicommodity Flow Problem

- ▶ undirected (weighted) graph $G = (V, E, c)$
- ▶ commodities (s_i, t_i) , $i \in \{1, \dots, k\}$
- ▶ a **multicommodity flow** is a flow $f : E \times \{1, \dots, k\} \rightarrow \mathbb{R}^+$
 - ▶ for all edges $e \in E$: $\sum_i f_i(e) \leq c(e)$
 - ▶ for all nodes $v \in V \setminus \{s_i, t_i\}$:
$$\sum_{u:(u,v) \in E} f_i((u, v)) = \sum_{w:(v,w) \in E} f_i((v, w))$$

Goal A (Maximum Multicommodity Flow)

maximize $\sum_i \sum_{e=(s_i, x) \in E} f_i(e)$

Goal B (Maximum Concurrent Multicommodity Flow)

maximize $\min_i \sum_{e=(s_i, x) \in E} f_i(e) / d_i$ (throughput fraction), where d_i is demand for commodity i

Valiants Trick

Multicommodity Flow Problem

- ▶ undirected (weighted) graph $G = (V, E, c)$
- ▶ commodities (s_i, t_i) , $i \in \{1, \dots, k\}$
- ▶ a **multicommodity flow** is a flow $f : E \times \{1, \dots, k\} \rightarrow \mathbb{R}^+$
 - ▶ for all edges $e \in E$: $\sum_i f_i(e) \leq c(e)$
 - ▶ for all nodes $v \in V \setminus \{s_i, t_i\}$:
$$\sum_{u:(u,v) \in E} f_i((u, v)) = \sum_{w:(v,w) \in E} f_i((v, w))$$

Goal A (Maximum Multicommodity Flow)

maximize $\sum_i \sum_{e=(s_i, x) \in E} f_i(e)$

Goal B (Maximum Concurrent Multicommodity Flow)

maximize $\min_i \sum_{e=(s_i, x) \in E} f_i(e) / d_i$ (throughput fraction), where d_i is demand for commodity i

Valiants Trick

Multicommodity Flow Problem

- ▶ undirected (weighted) graph $G = (V, E, c)$
- ▶ commodities (s_i, t_i) , $i \in \{1, \dots, k\}$
- ▶ a **multicommodity flow** is a flow $f : E \times \{1, \dots, k\} \rightarrow \mathbb{R}^+$
 - ▶ for all edges $e \in E$: $\sum_i f_i(e) \leq c(e)$
 - ▶ for all nodes $v \in V \setminus \{s_i, t_i\}$:
$$\sum_{u:(u,v) \in E} f_i((u, v)) = \sum_{w:(v,w) \in E} f_i((v, w))$$

Goal A (Maximum Multicommodity Flow)

maximize $\sum_i \sum_{e=(s_i, x) \in E} f_i(e)$

Goal B (Maximum Concurrent Multicommodity Flow)

maximize $\min_i \sum_{e=(s_i, x) \in E} f_i(e) / d_i$ (throughput fraction), where d_i is demand for commodity i

Valiants Trick

Multicommodity Flow Problem

- ▶ undirected (weighted) graph $G = (V, E, c)$
- ▶ commodities (s_i, t_i) , $i \in \{1, \dots, k\}$
- ▶ a **multicommodity flow** is a flow $f : E \times \{1, \dots, k\} \rightarrow \mathbb{R}^+$
 - ▶ for all edges $e \in E$: $\sum_i f_i(e) \leq c(e)$
 - ▶ for all nodes $v \in V \setminus \{s_i, t_i\}$:
$$\sum_{u:(u,v) \in E} f_i((u, v)) = \sum_{w:(v,w) \in E} f_i((v, w))$$

Goal A (Maximum Multicommodity Flow)

maximize $\sum_i \sum_{e=(s_i, x) \in E} f_i(e)$

Goal B (Maximum Concurrent Multicommodity Flow)

maximize $\min_i \sum_{e=(s_i, x) \in E} f_i(e) / d_i$ (**throughput fraction**), where d_i is **demand for commodity i**

Valiants Trick

A **Balanced Multicommodity Flow Problem** is a concurrent multicommodity flow problem in which incoming and outgoing flow is equal to

$$c(v) = \sum_{e=(v,x) \in E} c(e)$$

Valiants Trick

For a multicommodity flow S we assume that we have a decomposition of the flow(s) into flow-paths.

We use $C(S)$ to denote the congestion of the flow problem (inverse of throughput fraction), and $D(S)$ the length of the longest routing path.

Valiants Trick

For a multicommodity flow S we assume that we have a decomposition of the flow(s) into flow-paths.

We use $C(S)$ to denote the congestion of the flow problem (inverse of throughput fraction), and $D(S)$ the length of the longest routing path.

For a network $G = (V, E, c)$ we define the **characteristic flow problem** via

- ▶ demands $d_{u,v} = \frac{c(u)c(v)}{c(V)}$

Suppose the characteristic flow problem has a solution S with $C(S) \leq F$ and $D(S) \leq F$.

For a network $G = (V, E, c)$ we define the **characteristic flow problem** via

- ▶ demands $d_{u,v} = \frac{c(u)c(v)}{c(V)}$

Suppose the characteristic flow problem has a solution S with $C(S) \leq F$ and $D(S) \leq F$.

Definition 84

A (randomized) oblivious routing scheme is given by a path system \mathcal{P} and a weight function w such that

$$\sum_{p \in \mathcal{P}_{s,t}} w(p) = 1$$

Construct an oblivious routing scheme from S as follows:

- ▶ let $f_{x,y}$ be the flow between x and y in S



$$f_{x,y} \geq d_{x,y}/C(S) \geq d_{x,y}/F = \frac{1}{F} \frac{c(x)c(y)}{c(V)}$$

- ▶ for $p \in \mathcal{P}_{x,y}$ set $w(p) = f_p/f_{x,y}$

gives an oblivious routing scheme.

Valiants Trick

We apply this routing scheme twice:

- ▶ first choose a path from $\mathcal{P}_{s,v}$, where v is chosen uniformly according to $c(v)/c(V)$
- ▶ then choose path according to $\mathcal{P}_{v,t}$

If the input flow problem/packet routing problem is balanced doing this randomization results in flow solution S (twice).

Hence, we have an oblivious scheme with congestion and dilation at most $2F$ for (balanced inputs).

Valiants Trick

We apply this routing scheme twice:

- ▶ first choose a path from $\mathcal{P}_{s,v}$, where v is chosen uniformly according to $c(v)/c(V)$
- ▶ then choose path according to $\mathcal{P}_{v,t}$

If the input flow problem/packet routing problem is balanced doing this randomization results in flow solution S (twice).

Hence, we have an oblivious scheme with congestion and dilation at most $2F$ for (balanced inputs).

Example: hypercube.

Oblivious Routing for the Mesh

We can route any permutation on an $n \times n$ mesh in $\mathcal{O}(n)$ steps, by x - y routing. Actually $\mathcal{O}(d)$ steps where d is the largest distance between a source-target pair.

What happens if we do not have a permutation?

$x - y$ routing may generate large congestion if some pairs have a lot of packets.

Valiants trick may create a large dilation.

Oblivious Routing for the Mesh

We can route any permutation on an $n \times n$ mesh in $\mathcal{O}(n)$ steps, by x - y routing. Actually $\mathcal{O}(d)$ steps where d is the largest distance between a source-target pair.

What happens if we do not have a permutation?

$x - y$ routing may generate large congestion if some pairs have a lot of packets.

Valiants trick may create a large dilation.

Oblivious Routing for the Mesh

We can route any permutation on an $n \times n$ mesh in $\mathcal{O}(n)$ steps, by x - y routing. Actually $\mathcal{O}(d)$ steps where d is the largest distance between a source-target pair.

What happens if we do not have a permutation?

$x - y$ routing may generate large congestion if some pairs have a lot of packets.

Valiants trick may create a large dilation.

Oblivious Routing for the Mesh

We can route any permutation on an $n \times n$ mesh in $\mathcal{O}(n)$ steps, by x - y routing. Actually $\mathcal{O}(d)$ steps where d is the largest distance between a source-target pair.

What happens if we do not have a permutation?

$x - y$ routing may generate large congestion if some pairs have a lot of packets.

Valiants trick may create a large dilation.

Let for a multicommodity flow problem P $C_{\text{opt}}(P)$ be the optimum congestion, and $D_{\text{opt}}(P)$ be the optimum dilation (by perhaps different flow solutions).

Lemma 85

There is an oblivious routing scheme for the mesh that obtains a flow solution S with $C(S) = \mathcal{O}(C_{\text{opt}}(P) \log n)$ and $D(S) = \mathcal{O}(D_{\text{opt}}(P))$.

Let for a multicommodity flow problem P $C_{\text{opt}}(P)$ be the optimum congestion, and $D_{\text{opt}}(P)$ be the optimum dilation (by perhaps different flow solutions).

Lemma 85

There is an oblivious routing scheme for the mesh that obtains a flow solution S with $C(S) = \mathcal{O}(C_{\text{opt}}(P) \log n)$ and $D(S) = \mathcal{O}(D_{\text{opt}}(P))$.

Lemma 86

For any oblivious routing scheme on the mesh there is a demand P such that routing P will give congestion $\Omega(\log n \cdot C_{\text{opt}})$.